

**The Acquisition of Scope
Interpretation in Dative
Constructions**

Explaining children's non-targetlike performance

Published by
LOT
Trans 10
3512 JK Utrecht
The Netherlands

phone: +31 30 253 6006

e-mail: lot@uu.nl
<http://www.lotschool.nl>

Cover illustration: *Rijksstraatweg* by Marie-Elise van der Ziel

ISBN: 978-94-6093-081-2
NUR 616

Copyright © 2012: Marie-Elise van der Ziel. All rights reserved.

The Acquisition of Scope Interpretation in Dative Constructions

Explaining children's non-targetlike performance

De Verwerving van Kwantorenbereik in
Datiefconstructies

Een verklaring voor afwijkende interpretaties door
kinderen

(met een samenvatting in het Nederlands)

Proefschrift

ter verkrijging van de graad van doctor aan de Universiteit Utrecht
op gezag van de rector magnificus, prof.dr. G.J. van der Zwaan,
ingevolge het besluit van het college voor promoties in het openbaar te
verdedigen

op woensdag 13 juni 2012 des ochtends te 10.30 uur

door

Maria Elisabeth van der Ziel

geboren op 16 januari 1984
te Apeldoorn

Promotor: Prof.dr. P.H.A. Coopmans
Co-promotor: Dr. A. Gualmini

Table of Contents

Acknowledgments
Chapter 1 Introduction	1
1.1 Scope and Quantification	3
1.2 Scope Interaction and Scope Constraints across Languages.....	4
1.3 The Double-Object Construction	8
1.3.1 Structure.....	8
1.3.2 Frozen Scope.....	13
1.4 Explaining Scope Freezing	15
1.4.1 A Syntactic Account: Bruening (2001)	16
1.4.2 An Information-Structural Account: Goldberg (2006)	22
1.5 Outline of the study	25
1.5.1 Chapter 2: The Reverse-Pattern	25
1.5.2 Chapter 3: The Indefinite	26
1.5.3 Chapter 4: The Universal Quantifier	26
1.5.4 Chapter 5: Distributivity	26
1.5.5 Chapter 6: An Account	27
Chapter 2 The Reverse Pattern	29
2.1 Introduction.....	29
2.2 The Acquisition of Frozen Scope in Dative Constructions.....	31
2.3 (Frozen) Scope in Simple Transitive Sentences	35
2.3.1 Dutch	35
2.3.2 English	37
2.4 The Acquisition of Frozen Scope in Dutch: An Experiment	40
2.4.1 Participants.....	40
2.4.2 Design and Procedure	40
2.4.3 Materials	44
2.4.4 Results	46
2.5 Discussion.....	53
2.5.1 Inverse Scope of the Universal Quantifier	54
2.5.2 Incomplete Syntax Acquisition	55
2.5.3 The Reverse-pattern and Exhaustive Pairing	56
2.6 Conclusion	58
Chapter 3 Lexical Factors I: The Indefinite.....	61
3.1 Introduction.....	61
3.2 The Lexical Factor Hypothesis	62
3.2.1 Reanalyzing the Lexical Factor Hypothesis.....	63

3.2.2 Why would children misanalyze ‘a/an’?.....	63
3.2.3 What does it mean to analyze ‘a/an’ as ‘any’?.....	66
3.3 The Non-Integration Hypothesis.....	72
3.4 The Singleton Restriction Hypothesis.....	76
3.5 Experiment II: Testing <i>Some</i> (singular).....	80
3.5.1 <i>Some</i> (singular) vs <i>a/an</i>	81
3.5.2 Participants.....	83
3.5.3 Design and Procedure.....	83
3.5.4 Materials.....	84
3.5.5 Results.....	85
3.5.6 Discussion.....	89
3.6 Experiment III: Testing the Numeral.....	91
3.6.1 Participants.....	92
3.6.2 Design.....	92
3.6.3 Results.....	94
3.6.4 Discussion.....	96
3.7 Intermediate Conclusion.....	98
3.8 Experiment IV: Twice.....	99
3.8.1 Participants.....	99
3.8.2 Design and Procedure.....	99
3.8.3 Results.....	101
3.8.4 Discussion.....	102
3.9 General Discussion and Conclusion.....	102

Chapter 4 Lexical Factors II: The Universal Quantifier 105

4.1 Introduction.....	105
4.2 Relating the Reverse-pattern to Universal Quantification.....	106
4.2.1 Properties of Universal Quantification.....	106
4.2.2 Distributive vs. Collective Universal Quantification.....	109
4.2.3 The Distributivity Hypothesis.....	112
4.3 Experiment V: Testing <i>Drie</i>	118
4.3.1 Participants.....	119
4.3.2 Design and Procedure.....	119
4.3.3 Results.....	120
4.3.4 Discussion.....	121
4.4 Experiment VI: Testing <i>Alle</i>	121
4.4.1 Participants.....	122
4.4.2 Design and Procedure.....	122
4.4.3 Results.....	123
4.5 Discussion.....	126
4.6 Conclusion.....	127

Chapter 5 Distributivity	129
5.1 Introduction.....	129
5.2 Distributivity.....	130
5.2.1 Distribution over Events.....	132
5.3 Tunstall (1998): The Event-Distributivity Condition.....	133
5.4 Experiment VII: Event Distributivity.....	138
5.4.1 Participants.....	139
5.4.2 Design.....	139
5.4.3 Results.....	143
5.4.4 Discussion.....	145
5.5 Experiment VIII: Prototypical Distributivity.....	147
5.5.1 Participants.....	150
5.5.2 Design and Procedure.....	150
5.5.3 Results.....	156
5.6 Discussion.....	162
Chapter 6 An Account	167
6.1 The Reverse-pattern.....	167
6.2 The Indefinite.....	168
6.3 Universal Quantification.....	169
6.4 Distributivity.....	169
6.5 The Account.....	171
6.5.1 Prototypical Distributivity and Full Set Linking.....	171
6.5.2 Frozen Scope.....	178
6.5.3 Conclusion.....	181
References	183
Appendix1 Test Stories Experiment I	193
Appendix 2 Child Performance Experiment I	204
Appendix 3 Stories Experiment II, III, V and VI	205
Appendix 4 Story Experiment IV	218
Appendix 5 Sample Materials Experiment VII	219
Appendix 6 Stories Experiment VIII	220
Appendix 7 Individual Performance Patterns Experiment VIII	227
Appendix 8 The Data	229

Samenvatting in het Nederlands..... 257

Curriculum Vitae 265

Acknowledgments

First of all, I would like to thank my supervisors Peter Coopmans and Andrea Gualmini. Peter always encouraged me to follow my own instincts and in meetings always managed to ask exactly those questions which needed to be asked and which propelled my work forward. In addition, I could always rely on him for very precise readings of my drafts, and for finding all those little writing errors which I missed. Andrea was always thinking along with me. He had an enormous amount of faith in my abilities and took seriously any idea I had. In addition he was always positive and encouraging, as well as very generous with his time. It really was a pleasure to work with both of them.

Second, I would like to thank Bill Philip. Bill was the person who first introduced me to linguistics when I was a BA-student of English. He supervised and supported me throughout my BA- and MA-degrees and continued to be someone I could turn to during my PhD. I do not think I have ever properly thanked him for his support during the past seven or eight years, so 'Thank you'.

My research consisted of a large number of experiments and without the cooperation of many primary schools and their directors and teachers, none of this work would have been possible. Therefore, I would sincerely like to thank the teachers and directors of the following Dutch schools: OMS Den Dolder (Yvonne van der Klundert and Marjolein Akkermans), OMS Sumatralaan, Zeist (Karin de Leeuw, Mirte van den Berg), Kerckeboschschool, Zeist (Ronald Nagtegaal and Renske van der Vark), OMS Griffensteyn (Ida van der Kooij, Anouk Niesink, Viveke Maljers) and De Vlaswiek, Houten (Jeanette van Os). In addition, a large number of Canadian daycares (most of them in or near Toronto) took part in the English-language experiments. These daycares include Hester How, Lifebridge, Centro-Clinton's, Montrose, Garrison Creek and St. Stephen's Waterfront.

I could not have carried out my experiments on my own, and have been very lucky to have worked with a group of very good assistants. I would like to thank John-Sebastian Schutter, Lieselotte Smets, Rianne Oostwoud-Wijdenes, Laura Tejedor Timomor, Aster Dijkgraaf and Atty Schouwenaars for their assistance in running the Dutch child experiments. Arieke Vreugdenhil not only assisted me in the running of my experiments, but also drew the pictures for the child experiments, for which I am very grateful. Charlie Claessen, Aikaterini Pantoula and Louisa Meroni were instrumental in the design and execution of the experiment involving Dutch-

speaking adults. For their role in the English child experiments, I would like to thank: Michelle St. Amour, Ailis Cournane, Sandrine Tailleir, Alexandra Imperiale, Jana Reifegerste, Hope Valeriotte. I would also like to express my gratitude to Alyona Belikova for testing multiple groups of English-speaking adults for me.

In addition to the people who assisted me with my experiments, many other people have been instrumental in my progress. Some of them took time to discuss my work with me, while others offered much needed support and friendship. In alphabetical order these are: Frans Adriaans, Ana Aguilar Guevara, Sergey Avrutin, Gerhard Bos, Eefje Boef, Natalie Boll-Avetisyan, Bert LeBruyn, Anneloes Canestrelli, Desiree Capel, Xiaoli Dong, Jakub Dotlacil, Lizet van Ewijk, Gaetana Fiorin, Gianluca Giorgolo, Nadya Goldberg, Bettina Gruber, Sander van der Harst, Petra Hendriks, Bart Hollebrandse, Loes Koring, Kiki Kushartanti, David van der Linden, Marijana Marelj, Hannah de Mulder, Emilienne Ngangoum, Pelin Onar, Liv Persson, Maarten Prot, Dagmar Schadler, Rianne Schippers, Maaïke Schoorlemmer, Maartje Schulpen, Hanneke Takken, Sharon Unsworth, Anna Volkova, Widhyasmaramurti, and anyone I may have forgotten. In addition, I would like to thank my former housemates Andrea Karambelas, Wilco de Jong, Rik Zwalua, Ruud van Uden, Stefanie van Berkel for just being there to listen to me.

Finally, I would like to thank my family (in particular my mother Ineke, my sister Charlotte and my brother Jelmer). I know that they did not really understand what I was doing or why I chose to do it in the first place, but their unconditional support meant a lot to me.

Chapter 1

Introduction

At the age of five, children have acquired many of the intricacies of their first language. They possess a sizable lexicon and are in command of (nearly) all of the syntactic structure of the language(s) they are acquiring. However, preschool children are not fully adultlike in their interpretation of sentences containing quantified expressions yet. There is, for instance, a large body of L1-acquisition research which investigates children's non-targetlike interpretation of sentences like (1):

- (1) Every boy is riding a camel.

When this type of sentence is presented in situation in which every individual boy is riding a different camel, but there is also an additional camel that does not have a rider, five-year old children tend to judge the test sentence to be false. When asked why they think the sentence is false, they generally refer to the riderless camel. This phenomenon (first noticed in Inhelder and Piaget, 1964) is known as Exhaustive Pairing (Donaldson and Lloyd, 1974; Freeman, Sinha and Stedmon, 1982; Roeper and de Villiers, 1991; Philip, 1995; Crain et al., 1996; Drozd, 2001, Geurts, 2003; among many others).¹

In addition, children are known to often differ from adults in their interpretation of scope ambiguous sentences. Consider sentence (2), in which a negative operator interacts with a universal quantifier:

- (2) Every horse didn't jump over the fence.

Musolino (1998) observed that while adults generally derive the meaning where not every horse jumped over the fence (e.g. the interpretation that ensues when the negative operator is interpreted with wide scope), children seem unable to derive this interpretation and take the sentence to mean that none of the horses jumped over the fence. In this case the universal quantifier is interpreted with wide scope (for every horse it is the case that it did not jump over the fence). When presented with sentence (2) or other

¹ This same phenomenon has also been referred to as Quantifier Spreading and Symmetrical Interpretation.

sentences in which a negative operator interacts with some other scope-taking expression, English-speaking children seem able to derive the surface scope interpretation, but not the inverse scope interpretation. This is referred to as the Observation of Isomorphism. That is, children only derive the interpretation in which the scope relations are isomorphic to the surface syntactic relations that obtain between the two quantified phrases (Musolino, 1998; Lidz and Musolino, 2002; Musolino and Lidz, 2003, 2006). However, Isomorphism is by no means undisputed. For one, it has been observed that in some cases children seem to prefer inverse scope, as is the case for Dutch-speaking children when they are presented with sentences like (3). Whereas for adults sentence (3) can only mean that there is a certain fish that the boy did not catch, children take the sentence to mean that the boy did not catch any fish (see Krämer, 2000).

- (3) *De jongen heeft een vis niet gevangen.*
 the boy has a fish not caught.
 ‘The boy didn’t catch a fish’.

Furthermore, in certain (discourse-related) circumstances, children have no problems accessing an inverse scope interpretation (Gualmini 2004; Hulsev et al, 2004; among others).

In all of the above examples children for some reason or other assign a non-targetlike meaning to the sentences. In this dissertation we will attempt to address the question of why children are often unable to assign adultlike meanings to sentences containing quantified expressions. We will investigate this question not by investigating Exhaustive Pairing or sentences containing negation, but we will rather focus on a less well-studied phenomenon, where the so-called Scope Freezing constraint prohibits a wide scope interpretation of the direct object over the indirect object in sentences such as (4).

- (4) a. The bear gave a hedgehog every cake.
 (a>>every; *every>>a)
 b. *De beer heeft een egel elke taart gegeven.*
 the bear has a hedgehog every cake given
 ‘The bear gave a hedgehog every cake)
 (een>> elke; *elke>>een)

Though there is only a limited amount of research on children’s interpretation of sentences like (4), the results of Su and Crain (2000) and Su (2001a,b) suggest that children’s interpretation of these sentences is

strikingly non-targetlike. That is, many children reject the interpretation that adults assign to this sentence, but accept an interpretation of this sentence that is blocked for adults, a performance pattern which we will refer to as the Reverse-pattern. It is this performance pattern which is the main topic of this study.

Before turning to an in-depth investigation of the double object construction, we will first introduce some terminology and some basic assumptions relating to scope assignment which we will refer to throughout this study. This is followed by an overview of the types of scope constraints that can be operative in languages, which serves to elucidate the learning task that children face when acquiring targetlike restrictions on quantifier scope interaction. We will subsequently focus on double-object constructions and discuss their syntactic structure, the nature of the scope constraint and a selection of accounts proposed to explain this constraint (e.g. Bruening, 2001; Goldberg, 2006). This discussion will be followed by a short outline of the structure of this dissertation.

1.1 Scope and Quantification

In sentence (5) scope interaction between the indefinite and the universal quantifier is allowed, and therefore this sentence is ambiguous.

- (5)
- a. Someone loves everyone.
 - b. $\exists x [\text{Person}(x) \wedge \forall y [\text{Person}(y) \rightarrow \text{Loves}(x,y)]]$
 - c. $\forall y [\text{Person}(y) \rightarrow \exists x [\text{Person}(x) \wedge \text{Loves}(x,y)]]$

Sentence (5) can mean that a certain person has the property of loving everyone, as presented in predicate logic in (5b), and it can also mean that for every person it is the case that he or she is loved by (a possibly different) someone, as presented in (5c). In the former case the indefinite is said to take WIDE SCOPE over the universal quantifier and consequently the universal quantifier takes NARROW SCOPE with respect to the indefinite. In the latter case these relations are reversed: the universal quantifier takes wide scope and the indefinite takes narrow scope. In (5b) the scope assignment mirrors the surface ordering of the quantifiers in question. This interpretation is therefore often referred to as the SURFACE SCOPE INTERPRETATION. When the structurally lower quantifier takes wide scope over the hierarchically higher quantifier, the scope assignment is the reverse of the surface relations. In this case this quantifier is said to take INVERSE SCOPE.

In this dissertation we will assume that distinct scope interpretations are derived through an operation of Quantifier Raising (see May, 1977, 1985). Quantifier Raising (QR) is a covert movement operation which raises

quantified expressions to create licit/interpretable operator-variable pairs at the level of Logical Form, e.g. the syntactic level at which interpretation takes place. Opinions vary as to whether this operation is automatic and applies across-the-board, or whether economy principles restrict the application of this principle (e.g. Fox, 1995). For now we will assume that all quantified expressions obligatorily undergo QR. We will further assume that it is only the c-command relations at LF that determine the scope relations that obtain. When a quantifier c-commands another quantifier at LF, it takes wide scope over that quantifier.²

However, if quantifier raising always takes place, then shouldn't scope interaction always be allowed? We know that this is not the case. There are many factors which influence scope possibilities, like the lexical properties of the quantifiers involved, the particular configuration in which the quantifiers occur, the thematic roles that the DPs containing the quantifier are assigned, the animacy status of the DPs and the information-structural properties of the sentences and discourse the quantifiers occur in. In the next section we will illustrate the limits of quantifier scope interaction, and show that both between and within languages the possibilities for scope interaction differ greatly.

1.2 Scope Interaction and Scope Constraints across Languages

It is generally held that in a language like English scope interaction occurs quite freely. However, not all languages allow scope interaction to the same degree. In languages like Japanese, Chinese, German, Dutch, Russian, Korean and Turkish, the surface order of the quantifiers seems to determine the interpretation sentences can have. Inverse scope is blocked. Languages in which this is the case are sometimes referred to as Scope Rigid languages. As an illustration, consider the sentences in (6):

² C-command: α c-commands β if α does not dominate β and every γ that dominates α dominates β (Chomsky, 1986)

- (6) **German** (Wurmbrandt, 2008)
- a. *Mindestens ein Student hat jeden Roman gelesen.*
 at least one student has every novel read
 ‘At least one student read every novel’.
 $(\exists >> \forall; * \forall >> \exists)$
- Russian** (Ionin, 2001)
- b. *Odin malčik poceloval kazhjuju devochku.*
 one boy-NOM kissed every girl-ACC
 ‘One boy kissed every girl’.
 $(\exists >> \forall; * \forall >> \exists)$
- Japanese** (Sano, 2004)
- c. *Dareja-ga dono neko mo tukamaeta*
 someone-NOM every cat caught
 ‘Someone caught every cat’.
 $(\exists >> \forall; * \forall >> \exists)$

The German sentence (6a) only allows the interpretation where a certain set containing at least one student read every novel. It does not allow the interpretation where for every novel there is a different set of at least one student that read it. Similarly, the Russian sentence in (6b) can only mean that a single boy kissed every girl. The interpretation where every girl was kissed by a different boy is not available. Finally, the Japanese sentence (6c) can only have the interpretation where there is a certain person who caught every cat. The sentence is false when every cat is caught by a different person.

One way to explain these limitations on quantifier scope interaction in scope-rigid languages is to assume that the movement operation of quantifier raising is parametrized. That is, it is available in some languages (like English), but it is not available in languages like Japanese and German. Alternatively, we could posit language-specific principles in order to account for the lack of inverse scope. However, it is too simplistic to assume that some languages allow scope interaction whereas others do not. Within a language the possibilities for scope interaction are very much dependent on other factors, like the construction in which the quantifiers occur, the lexical characteristics of the quantifiers, and so on. Though English seems to allow scope interaction to a higher degree than some other languages, scope in English is by no means unrestricted. The double-object construction in (7), for instance, only allows the interpretation where a single man was shown all of a set of cars by the car salesman. The sentence cannot be uttered to assert that the car salesman showed each of the cars to a different man.

- (7) The car salesman showed a man every car.
(a>>every; *every>>a).

In sentences like (8) inverse scope is either dispreferred (as in (8c)) or even completely unavailable (8a,b).

- (8) a. Some student read more than two books.
(some student>>more than 2)
b. Some student read most books (some>> most books)
c. Some student read all (the) books.
(some>> all = strongly preferred)

When the subject of the sentence is *Most NP*, *No NP* or *Few NP*, scope interaction is again limited. In the sentences in (9), the only possible interpretation is the surface scope interpretation.

- (9) a. Most students read every book.
(most students >> every book)
b. No boy kissed every girl. (no boy >> every girl)
c. Few people belong to every church.
(few people>> every church)

In addition, it turns out that in languages that are generally considered to be scope-rigid, inverse scope is not completely disallowed. Whereas in (6c) scope interaction is not allowed, Goro (2007) shows that inverse scope is more acceptable when the subject quantifier is a modified numeral quantifier like ‘more than two’. According to Goro, sentence (10) allows the interpretation where every individual professor is criticized by a distinct group of more than two students.

- (10) *Hutari ijoy-no gakusei-ga ono kyoujyu-mo*
two greater than-GEN students-NOM every professor
hihan sita.
criticize did.
More than two students criticized every professor.

The type of modal context in which the quantifiers are presented also affects the scope possibilities. In imperative, counterfactual, and assumptive contexts inverse scope is more accessible than in factive, indicative and implicative contexts (Goro, 2007: 98). It is possible to derive an inverse scope interpretation of the universal quantifier in the imperative in (11), and

thus to arrive at the interpretation where every room is cleaned by a different ‘someone’. In contrast, inverse scope (and thus the interpretation where for every room it was the case that a different person managed to clean it) is impossible in the implicative example in (12).

- (11) *Dareka-ga dono heya mo souji-si nakereba naranai.*
 someone-NOM every room clean do unless mood
 “It is imperative that someone cleans every room.”
- (12) *Dareka-ga dono heya mo souji-site noketa.*
 someone-NOM every room clean-do managed
 “Someone managed to clean every room.”

It is also well-known that in scope-rigid languages like Japanese and German, the application of scrambling often leads to ambiguous sentences (see Frey, 1993 and Krifka, 1998 for German and Sano, 2004 for Japanese). In sentence (13) the direct object *mindestens einen Roman* is moved from its base-position within the VP to a position in the left-periphery of the sentence. After this movement operation, this sentence can mean that there is at least one novel that every student read (e.g. the surface scope interpretation), but also that for every student it is the case that there is at least one novel that he has read. In the latter case not all students need to have read the same book(s).

- (13) [*Mindestens einen Roman*]_i hat jeder Student *t_i* gelesen.
 [at least one novel] has every student *t* read

Finally, the intonation contour of the sentence, and in particular the way this contour interacts with the information structure of the sentence, affects the availability of inverse scope interpretations in at least German (Büring, 1997; among others). In sentence (14) a wide scope interpretation of the universal quantifier *jeden* (‘every’) is much more accessible than that same sentence (e.g. (6a)) pronounced with a neutral, declarative intonation contour.

- (14) Mindestens /EIN Student hat \JEDen Roman gelesen.
 (topic-focus accent, root contour)

In sum, in this section we have shown that it is not the case that some languages allow scope interaction and others do not. In a language like English, which is generally thought to be relatively free with regard to allowing scope interaction, inverse scope is in fact not always allowed. In

the examples we have discussed above, the availability of inverse scope depends on the construction in which the quantifiers occur (see the double-object construction in (7)) and the specific quantifiers that occur in the test sentences such as in (8) and (9). In languages like Japanese and German, which are often considered to be Scope Rigid languages, scope is in fact not completely rigid. We have seen a number of cases in which inverse scope does seem to be allowed. That is, it matters whether movement has taken place (13) and which specific subject quantifier is used (10). In addition, the modal context and the intonation contour with which an utterance is pronounced also affect the availability of inverse scope (see (11), (12) and (14)).

The above discussion has naturally ignored many subtleties. However, what it has attempted to convey is that in all languages, whether they are considered scope rigid or not, scope interaction is a complex matter. The child's learning task is no easy feat. The set of factors that determine whether scope interaction is or is not available is a diverse set, ranging from syntactic factors, to lexical factors, to information-structural factors. In this study we will restrict ourselves to an investigation of the acquisition of a single constraint on scope interaction, namely the Scope Freezing constraint in double-object constructions. In the next section we will discuss the particulars of the construction we are interested in. We will first examine its internal structure and its relation to other dative constructions. This will be followed by an investigation of the scope constraint itself, after which we will discuss two possible accounts of this phenomenon: Bruening's (2001) syntactic account and Goldberg's (2006) information-structural account.

1.3 The Double-Object Construction

1.3.1 Structure

Before examining the scope constraint in double-object constructions, we will first examine the syntactic structure of double-object constructions like (15).

(15) Tom sent Susan a letter.

Barrs and Lasnik (1986) first showed that in double-object constructions the two objects do not have the same status. Whereas the indirect object can bind anaphors and variables in the direct object, the reverse does not hold. These asymmetries suggest that the indirect object c-commands the direct object, which in turn implies that the indirect object must be in a structurally

higher position than the direct object. This fact led Larson (1988) to propose his VP-shell analysis of double-object constructions. In this study we will adopt the structure of double-object constructions as proposed by Larson. However, before examining his analysis in detail, we will first take a closer look at a selection of the asymmetries described in Barrs and Lasnik (1986).

Consider the examples in (16), (17) and (18):

- (16) Anaphor binding
- a. I showed Tom_i himself_i (in the mirror).
 - b. *I showed himself_i Tom (in the mirror).
- (17) Quantifier-Pronoun binding
- a. I gave every worker_i his_i paycheck.
 - b. *I gave its_i owner every paycheck_i.
- (18) Negative Polarity Items
- a. I gave no one anything.
 - b. *I gave anyone nothing.

In order for a reflexive like *himself* to be bound it needs to be c-commanded by a suitable antecedent. In sentence (16a) the reflexive in the direct object can be bound by the proper noun *Tom* in the indirect object. However, it is not possible for a reflexive in the indirect object to be bound by the direct object, as the unacceptability of (16b) shows. Similarly, quantifiers can bind variables when these variables occur in their c-command domain. In (17a) the universally quantified phrase *every worker* can bind the pronoun in the direct object and the pronoun can thus be interpreted as a bound variable, leading to the interpretation where every worker that he receives his own check. However, a quantified expression in the direct object cannot bind a pronoun in the indirect object (as shown in (17b)). Finally, a Negative Polarity Item (NPI) like *anything* or *anyone* is licensed when it is c-commanded by some negative operator.³ When the NPI occurs in the direct object and the negative operator in the indirect object, the use of the NPI is licensed, as shown in (18a). The use of an NPI in (18b), where the NPI occurs in the indirect object and the negative operator in the direct object, leads to ungrammaticality.

All of the above phenomena crucially rely on c-command. That is, anaphors and variables need to be c-commanded by their antecedent to be bound and NPIs need to be c-commanded by an appropriate licenser. Since

³ This is a simplification. In chapter 3 (section 3.2.3), we will argue, following Giannakidou (2002), that Negative Polarity Items are licensed in so-called non-veridical contexts.

the sentences are only acceptable when the antecedent or licenser occurs in the indirect object and the bound element or the NPI occurs in the direct object, the indirect object must occupy a syntactic position in which it asymmetrically c-commands the direct object.

Similar asymmetries have been observed in *to*-datives like (19):

- (19) Tom sent a letter to Susan.

In the case of *to*-datives the direct object seems to c-command the prepositional phrase. Consider the examples (20), (21) and (22) below:

- (20) a. I showed Tom_i to himself_i (in the mirror).
 b. *I showed himself_i to Tom_i (in the mirror).
- (21) a. I gave every paycheck_i to its_i owner.
 b. ??I gave his_i paycheck to every worker_i.
- (22) a. I sent no presents to any of the children.
 b. *I sent any of the presents to none of the children.

The above examples show that the direct object can bind an anaphor or pronoun within the PP (see (20a) and (21a)), and can also licence NPI within the prepositional phrase (22a). However, when the antecedent and the negative operator occur within the prepositional phrase, unacceptability ensues, as shown in the b-sentences.

Larson assumed that *to*-datives and double-object constructions share the same base structure, and that both constructions are derived from this base structure by a variety of (movement) operations. This presupposes that the two constructions are in fact intimately related. It has often been argued that these two constructions are part of the so-called Dative Alternation. That is, many verbs in English like *give* or *sell* can be realized in two different ways, in a double-object construction and in a *to*-dative, while seemingly conveying exactly the same meaning.

The main innovation of Larson's analysis is the addition of a second VP-layer. This VP-layer is invisible in transitive and intransitive sentences, because in these cases it is empty. In dative constructions, however, this VP-layer becomes visible. Larson argues that the basic underlying structure for both *to*-datives and the double object construction is the following:

(23)

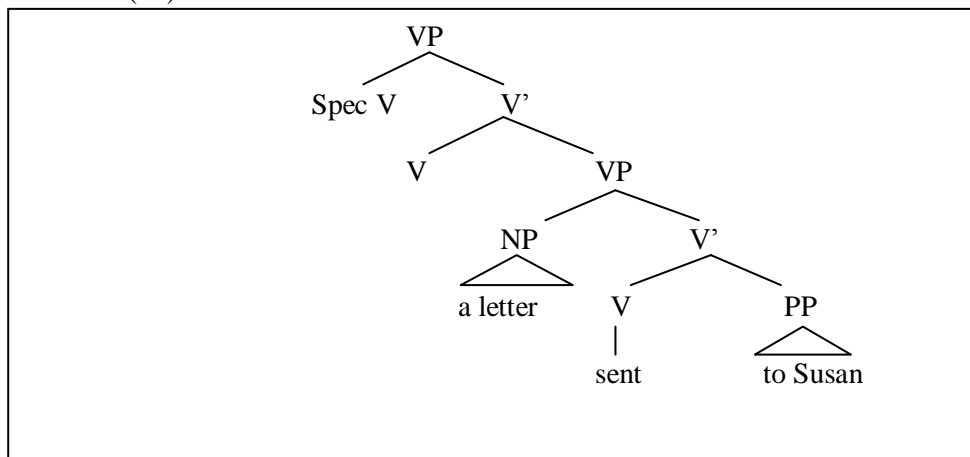

The *to*-dative is derived from this basic structure through the movement operation of V-raising. That is, the verb that heads the lower VP is raised into the empty V position in the second VP-layer through a form of head-to-head movement.

(24)

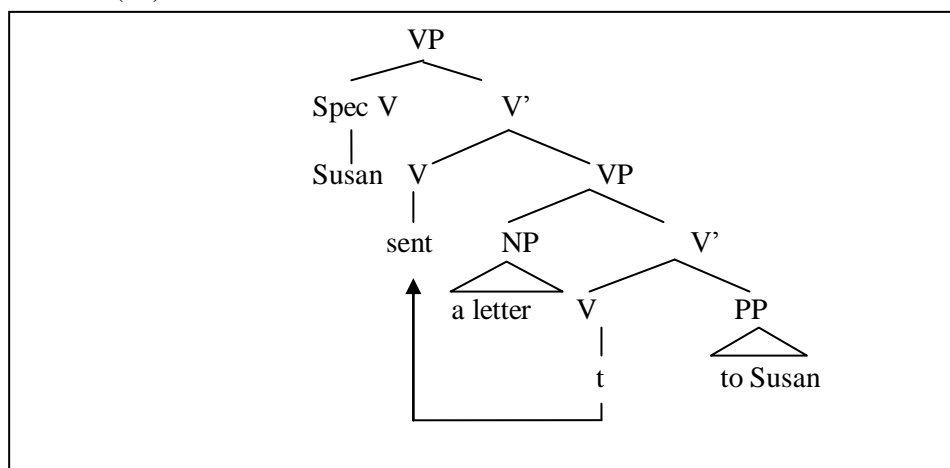

The derivation of the double-object construction is more complicated and proceeds in a number of different steps. Larson assumes that the double-object construction is derived from the base structure in (23) above through an operation similar to passive formation which applies to the lower VP-projection. In simple transitive sentences passive formation involves

absorption of both the Case that is assigned to the VP-internal object NP and the thematic role that is assigned to the subject. In the case of the dative construction, we will assume that in the deep VP in (23) the direct object NP in Spec VP corresponds to the subject and the indirect object NP corresponds to the VP-internal object. According to Larson the first step in the derivation is that case is withdrawn from the indirect object NP. Larson assumes that the preposition *to* in fact only serves as a case-marker, and thus withdrawing case has the consequence of absorbing this preposition. Next the thematic role assigned to the direct object undergoes argument demotion.⁴ While in standard passives the thematic role is suppressed, Larson assumes that in this case the thematic role (THEME) is there, but it is assigned in a different way. While in (23) the theta-role would be assigned by V' , after argument demotion it needs to be assigned to a V' adjunct. Therefore, the direct object is now realized as an adjunct to the V' that assigns its thematic role. The new structure is shown in (25) below. Then Dative Shift applies, that is the caseless indirect object raises to the empty (non-thematic) Spec VP position in order to receive case. Finally, the verb raises from the head of the lower VP to the empty head of the higher VP projection.

(25)

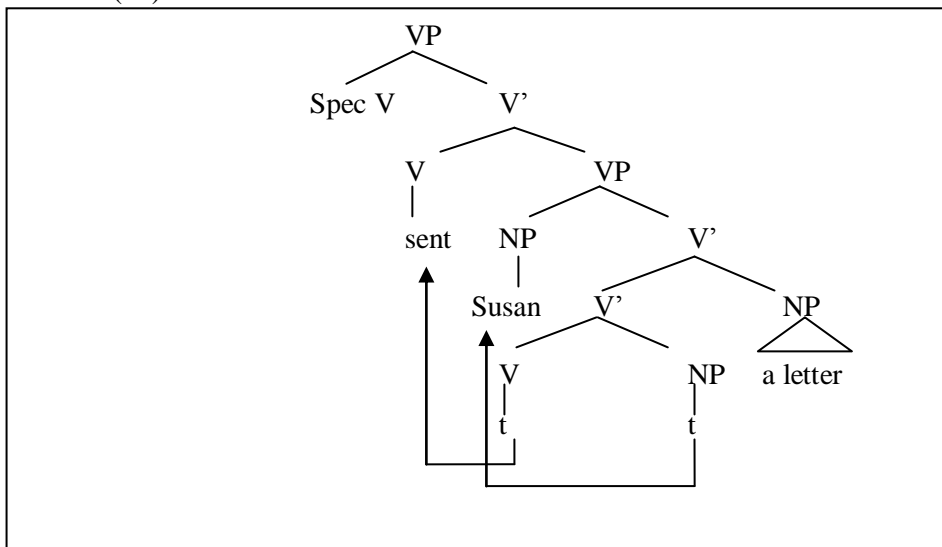

⁴ Argument demotion: If α is a θ -role assigned by X^i , then α may be assigned (up to optionality) to an adjunct of X^i .

In this section we started from the observation that there is a hierarchic relation between the two objects in the double-object construction. The indirect object *c*-commands the direct object. We have also discussed Larson's (1988) analysis of the syntactic structure and derivation of the double-object construction. This is the internal structure which we will assume throughout this dissertation. We can verify that in (25) the indirect object *c*-commands the direct object. In the next section we will start to examine the scope constraint that applies in double-object constructions, before turning to a selection of possible accounts of this scope constraint in section 1.3.3.

1.3.2 Frozen Scope

In this study we will be concerned with a specific constraint on scope assignment, namely the constraint that applies in double-object constructions like (7), repeated here as (26):

- (26) The car salesman showed a man every car.
(a>>every; *every>>a)

This constraint will be referred to as SCOPE FREEZING or the FROZEN SCOPE CONSTRAINT, the two terms will be used interchangeably. In a sentence like (26) the indirect object *a man* can scope over the direct object *every car*, but the inverse scope interpretation is not available. Hence, this sentence can have the interpretation where there is a certain man that the car salesman showed every car to, but cannot mean that for every individual car there is a (different) man that the car salesman showed it to (i.e., the interpretation derived through wide scope of the universal quantifier). The scope relations between the two objects are thus “frozen”; the quantified expression in the structurally higher object always takes wide scope over the quantified expression in the lower object NP.

Whereas scope is frozen in double-object constructions, this is not the case for all dative constructions. *To*-datives are scope ambiguous. The sentence in (27) allows both the surface scope interpretation (i.e., there is a certain car that the salesman showed to every man) and the inverse scope interpretation (i.e., for every individual man there is a (different) car that the salesman showed to him).

- (27) The car salesman showed a car to every man.
(a>> every; every>>a)

However, there are other constructions which do display a form of Scope Freezing, like for instance the *with*-variant of the Spray-Load alternation (Larson, 1990).⁵

- (28) a. Maud draped a sheet over every armchair.
(a>>every; every>>a)
b. Maud draped an armchair with every sheet.
(a>>every)

Sentence (25a) can describe a situation in which Maud draped a single (probably very large) sheet over all of the armchairs, or a situation in which she draped every armchair with a different sheet. However, the sentence in (25b) only allows a single armchair to be draped with all of the sheets. There cannot be different armchairs for each sheet. For the remainder of this study we will only be concerned with double-object constructions and will not pay special attention to the spray-load constructions.

Scope Freezing is generally perceived to be a relatively strong constraint on scope interaction. However, this does not mean that it is inviolable. Sentence (29) for instance readily allows the interpretation where for each Nobel Prize there are at least two people who received it. In fact, this interpretation seems to be preferred to the interpretation in which a specific set of at least two people are given each Nobel Prize by ‘them’.

- (29) They gave at least two people each Nobel Prize.
(preferred: each>> at least two)

Similarly, Aoun and Li (1989) noted that the double-object construction in (30) is ambiguous. It either means that there is a certain bureaucrat that Mary showed every document to, or that she showed every document she had to a different bureaucrat.

- (30) Mary showed some bureaucrat every document she had.
(some>> every; every>>some)

In addition, there is psycholinguistic research which suggests that for many adults the Frozen Scope Constraint is violable. Heizman (2008) investigated English and German-speaking adults’ interpretation of double

⁵ In fact, Scope Freezing occurs with a variety of different alternations, like the *material-product* alternation, the *clear*-alternation, the *image impression* alternation, among others (see Levin, 1993). In addition it occurs with verbs like *fill*.

object constructions like (31).⁶ The participants were asked to read a target sentence and to circle the interpretation they thought of first. In the case of (31) they were asked to decide whether Christine just showed one visitor every picture by Picasso, or whether there could be multiple visitors. Since adults should only allow a wide scope interpretation of the indefinite, and thus the interpretation where Christine showed a certain visitor every picture by Picasso, adults were expected to choose the ‘one visitor’-response.

- (31) Christine showed a visitor every picture by Picasso.
 a. one visitor
 b. several visitors

After this first judgment they were given the same sentences again, and were then asked to determine whether the interpretation they had not picked was also a possible interpretation of the test sentence. In this instance the two interpretations were paraphrased. For constructions like (31) the rate of acceptance of the inverse scope interpretation was very high. Nearly 40 percent of the English-speaking participants accessed the multiple-visitors interpretation during the first part of the experiment. Most of the participants who initially chose the one-visitor response were able to accept the multiple-visitors response in part two of the experiment. In total, nearly 95 percent of the adults could access an inverse scope interpretation, either as a first choice or in the second part of the questionnaire. Similar results were obtained for the German participants.

In sum, in this subsection we have shown that there is a scope constraint in double-object constructions, which we will refer to as either Scope Freezing or the Frozen Scope Constraint. This constraint prohibits inverse scope of the quantified direct object DP over the indirect object DP. The constraint is often perceived as a relatively strong constraint, though we have also shown that in certain sentences inverse scope does seem to be accessible. In addition, in a psycholinguistic study, most adults were in fact able to access the inverse scope interpretation.

1.4 Explaining Scope Freezing

Over the years a variety of different accounts of the Frozen Scope Constraint have been proposed (see for instance Larson, 1990; Aoun and Li, 1989; Naganishi, 2001a,b; Goldberg, 2006; Lechner, 2009). In this section we will discuss two accounts which are radically different from each other.

⁶ All participants were undergraduate students, but no further participant statistics were presented in this paper.

The first is Bruening's (2001) syntactic account of the phenomenon, which relates scope freezing to conditions on the application of Quantifier Raising. In particular, Bruening (2001) argues that while both the direct object and the indirect object are subject to QR, the application of an economy constraint prevents a reordering of the two objects at LF. Accordingly, there is no point in the derivation at which the direct object is in a position c-commanding (and thus taking scope over) the indirect object. The second account is Goldberg's (2006) Information-Structural Account. According to Goldberg, it is not so much c-command but rather the information-structural status of a quantified phrase that determines the expression's scope-taking potential. Elements that function as topics are generally interpreted with wide scope. She further argues that the indirect object (e.g. the recipient) in the double-object construction acts as a second(ary) topic and thus tends to take wide scope over the direct object (which does not have topic status). Let us now look at both accounts more closely.

1.4.1 A Syntactic Account: Bruening (2001)

Many accounts of the Scope Freezing Constraint (Larson, 1990; Aoun and Li, 1989, 1993; Maranz, 1993) have attempted to capture this constraint by assuming that the direct object cannot raise to a position in which it can take wide scope over the indirect object. Bruening (2001), however, argues that the direct object does undergo movement. To be precise, he argues that both the quantified indirect object and the quantified direct object undergo Quantifier Raising, but that additional constraints on this movement operation prohibit a reordering of the DPs.

Let us first review a selection of Bruening's arguments in favour of the assumption that Quantifier Raising applies to both objects. A first argument is provided by the observation that scope freezing only holds between the direct object and the indirect object. While the direct object cannot scope over the indirect object, it can take scope over a quantifier in subject position. Consider sentence (32):

- (32) At least two judges awarded me every medal.
(Bruening, 2001: 243)

In (32) the direct object *every medal* can take scope over the subject DP *at least two judges*. The sentence is true when every individual medal is awarded by a different set of at least two judges. If inverse scope always requires the structurally lower quantifier to covertly raise to a position in which it can c-command the higher quantifier, then this implies that the

direct object must be able to raise to a position in which it can c-command the subject.⁷

A second (rather technical) argument comes from sentences with Antecedent-Contained Deletion (ACD). Consider the sentence in (33):

- (33) Nigel likes to perform in every city that David does [VP Δ]
(Bruening, 2001: 240)

In (33) it seems as though the antecedent of the elided material contains the elided material, e.g. the antecedent is *like to perform in every city that David does [VP Δ]*. However, if this were indeed the antecedent, the sentence would go on ad infinitum: *Nigel likes to perform in every city that David likes to perform in every city that David likes to perform in every city that David likes to perform in every city*, etc. This would render the sentence uninterpretable. To solve this problem, it has been argued that the DP that contains the elided material should undergo QR (see Sag, 1976; May, 1985; Larson and May, 1990, among others), as shown in (34).

- (34) [every city that David does [VP Δ]]_x [Nigel [VP likes to perform in x]]

After this movement operation, the VP no longer contains elided material, thus avoiding the infinite regress.⁸ Now consider the following sentences:

- (35) a. Ozzy gave someone everything
b. Ozzy gave someone everything that Belinda did [VP Δ].
(*every>some, ACD=OK)

In (35a) and (35b) the direct object cannot take wide scope over *someone*. However, ACD is perfectly acceptable. Under the assumption that the quantified phrase [everything that Belinda did...] needs to undergo Quantifier Raising (and thus raise out of the VP [*gave someone ...*]) in order for the sentence to be interpretable, the position that the direct object does not move cannot be maintained.

⁷ Note that from this position the direct object should also be able to c-command the indirect object.

⁸ However, not everyone agrees that Quantifier Raising is necessary to resolve ACD. Hornstein (1994), for instance, argues that objects obligatorily A-raise to an AgrO projection outside of the VP. This would solve the problem of infinite regress without having to resort to QR. However, see Kennedy (1997) for arguments against Hornstein's analysis.

Based on the above evidence Bruening concludes that Scope Freezing is not caused by the inability of one of the objects to undergo movement. Rather, Bruening argues that whereas both quantifiers move, this movement operation cannot alter the scope relations that obtain between the two object quantifiers. According to Bruening, this constraint on the reordering of the quantified elements through movement is the same constraint that prevents a reordering of wh-elements in languages (especially Slavic languages) which allow multiple wh-movement. Consider (36):

- (36) a. *Koj_i kogo_j t_i vižda t_j?*
 who whom sees
 ‘Who sees whom’
 b. **Kogo_j koj_i t_i vižda t_j?*

In (36a) both the wh-element originating the object position and the wh-element in the subject position move. Crucially, the ordering of the wh-elements does not change. That is, the object wh-element cannot raise past the subject wh-element (as evidenced by the ungrammaticality of 36b). According to Richards (1997), both instances of wh-movement in (36a) target the same position. The subject wh-phrase first adjoins to this position, and the other wh-phrase is then “tucked in” under the other wh-phrase. Richards formalized this in the Shortest condition (Richards 1997: 113). Shortest incorporates both the principles of Shortest Attract and Shortest Move (cf. Chomsky’s 1995 Minimal Link Condition) and is meant to be a general condition applying to all movement operations alike. The formal definition of Attract is given in (37) below, and the definition of Shortest is presented in (38):

- (37) Attract:
 An attractor K attracts a feature F, creating a copy α' of an element α containing F and merging α' with K. The relations between α' , K and F must all obey shortest.

- (38) Shortest
 A pair P of elements $[\alpha, \beta]$ obeys Shortest iff there is no well-formed pair P' which can be created by substituting γ for either α or β , and the set of nodes c-commanded by one element of P' and dominating the other is smaller than the set of nodes c-commanded by one element of P and dominating the other.

Let us assume that QR targets the specifier of CP.⁹ The head of this CP can be associated with a Q-feature, a feature that requires appropriate elements (in this case a quantified element) to move to a specifier of this CP. Crucially, this Q-feature does not just attract a single quantifier to fill this specifier, but is able to attract all suitable elements. In the case of the double-object construction in (26) and (39) there are two elements which qualify and which could thus be raised to the appropriate position: the indefinite indirect object, and the direct object. However, only movement of the indirect object QP satisfies Shortest and thus creates a pair with the smallest set of intervening nodes. To be precise, when the indirect object is attracted, this creates a pair of elements {C, a man} with the smallest set of nodes that is c-commanded by C and that dominate [a man]. If the direct object were to raise first, then the pair {C, every car} would not satisfy Shortest because there would be a pair (namely {C, a man}) which is associated with a smaller set of nodes. Hence, the indirect object raises first. After it has raised to the specifier of the CP, the direct object can be attracted because there is no longer a pair that satisfies the conditions of Shortest better. However, now there are two possibilities, the direct object could raise to a higher Spec CP position in which it would c-command the indirect object, or it could ‘tuck under’. Shortest dictates that the latter happens. If the direct object QP were to raise past the indirect object, then there would be a pair of elements that would satisfy Shortest better, namely the pair {lower Spec CP, a man}. A very simplified derivation of the movement operations is presented in (39) below.

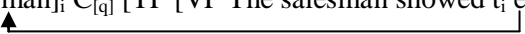
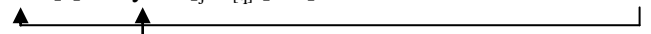
- (39) a. The salesman showed a man every car.
 b. [CP[a man]_i C_[q] [TP [VP The salesman showed t_i every car]]]

 c. [CP[a man]_i] [every car]_j C_[q] [TP[VP The salesman showed t_i t_j]]]

In this account, both at surface structure and at LF the indirect object c-commands the direct object and thus takes scope over it.¹⁰

⁹ Bruening assumes that QR targets the Spec of ν P and the head of this ν P (ν) is optionally realized with a P-feature that attracts a suitable element (a quantifier) to the Spec, ν P position. Since we did not introduce this projection in the section on the syntactic structure of double-object constructions, we have here assumed that QR targets the Spec of CP. For the purpose of the exposition above it is not important exactly where the quantifiers raise to, as long as they raise to a position outside of the lower VPs.

¹⁰ The application of Shortest and the subsequent ‘tucking-under’ creates crossing paths. However, since Pesetsky’s (1982) Path Containment Condition it has

The next question is why *to*-datives are ambiguous. Should Shortest not apply to this construction as well? Bruening argues that *to*-datives are ambiguous because both the PP and the object DP are sisters in the same (verbal) projection. In this case the two objects are equidistant with respect to their attractor and Shortest thus does not dictate which of the two raises first. In the Larsonian structure we have assumed in this chapter, this is not the case, as there the direct object occurs in the specifier of VP and the indirect object PP is a sister to V. Bruening therefore hypothesizes that the structure of the *to*-dative is not as presented in (24).¹¹ We will not go into this issue in here. The interested reader is referred to Bruening's work (Bruening, 2001: 265-267).¹²

To summarize, according to Bruening, Scope Freezing is an effect of a locality condition that applies to both overt and covert movement. The application of Shortest prevents a reordering of the two object quantifiers at the level of Logical Form. Accordingly, there is no point in the derivation at which the direct object is in a position to take scope over the indirect object. One advantage of Bruening's Account is that it makes strong predictions with regard to children's acquisition of the constraint. That is, as soon as children have knowledge of Shortest, they should also have acquired the scope constraint. We know that five-year old children have acquired most

generally been assumed that the paths of movement cannot cross and that when paths of movement overlap, one path must contain the other. One way to make the above account consistent with Path Containment is to assume that crossing paths are allowed in cases in which two movement operations target the same position (or two elements are attracted by the same attractor) and that in all other cases the Path Containment Conditions applies.

¹¹ Bruening proposes two possible structures in which the two objects are sisters in the relevant domain. One is a ternary branching structure in which both NP and PP are sisters of V. However, this structure has been rejected since the early days of X'-structure. A second possibility is a type of small clause structure in which the NP occurs in the specifier of PP and the P'-node is one of the nodes that is targeted by the movement operation(s). One motivation for the original Larsonian structure was the fact that in a *to*-dative the direct object seems to c-command the NP contained in the PP. Larson retains this fact by assuming that while the direct object NP and the indirect object PP (or P') may occur in a relation of mutual c-command (since they are sisters), the direct object NP still asymmetrically c-commands the NP containing within the PP.

¹² Another question is why the direct object is sometimes able to scope over the subject (as in (32)). Bruening assumes that while both the direct object and the indirect object raise because they are attracted by the same feature, the subject raises for a different reason. As such, Shortest does not determine the relative position of the subject and the object at LF (Bruening, 2001: 256-257).

aspects of wh-movement, and that they seem to be sensitive to constraints on this movement operation (Thornton, 1990; De Villiers et al. 1990; Lightbown and Spada, 1999; among many others). This suggests that children do obey Shortest and thus should have acquired the scope constraint. Nevertheless, we could argue that perhaps children have acquired the intricacies of overt movement, but do not (covertly) raise quantifiers. However, Lidz *et al* (2004) provided evidence which suggests that children do in fact apply QR. They allow a quantified expression to bind a pronoun in an adjunct that it does not c-command at surface structure. In addition, they can also interpret sentences containing Antecedent-Contained Deletion correctly. If ACD resolution indeed requires QR (see above for more information about the possible link between ACD and QR), then this also shows that children must be able to covertly raise quantifiers. Furthermore, we know that children are sometimes able to derive inverse scope interpretations (Gualmini, 2004, among others), which suggests that they must be able to raise hierarchically lower quantifiers to a position in which they can take scope over structurally higher quantifiers. In other words, since five-year old children seem to have acquired constraints on movement operations, they should, following Bruening (2001) also have knowledge of Scope Freezing. The only caveats are that in order for Scope Freezing to apply children need to have acquired the structure of the double-object construction as well as the specific properties of the lexical items in question. However, from about two years onwards children start to produce double-object constructions (see Snyder and Stromswold, 1997). From that age they should thus have knowledge of the basic structure of this construction, although there is also some evidence which suggests that children's comprehension of this construction lags behind (see sections 2.4.2 and 2.5.2). Furthermore, around age four children have at least some knowledge of quantification, which is evidenced by the fact that they produce quantified statements (Gordon, 1982; Hanlon, 1988), and seem to have acquired the syntactic and semantic properties of at least universal quantifiers (Crain et al. 1996; Brooks and Braine, 1996). In sum, Bruening's account would predict preschool children to have acquired the Frozen Scope Constraint.

However, while Bruening's account makes strong predictions for acquisition research, we already know that at least one of its theoretical predictions is not borne out. According to Bruening's account, Scope Freezing is a very strong, almost inviolable constraint. Inverse scope of the direct object over the indirect object can only be achieved by violating a very basic syntactic principle which is hypothesized to apply not only to covert movement, but also to all other types of movement. However, we have seen in section 1.3.2 that there are many cases in which adults are able to derive a

wide scope interpretation of the direct object. In the next section we will introduce an account that makes weaker predictions for acquisition reason, but that is able to capture the fact that in double-object constructions scope is not always frozen.

1.4.2 An Information-Structural Account: Goldberg (2006)

In the previous section we introduced Bruening's syntactic account of the Frozen Scope Constraint. We also showed that this account predicts that inverse scope of the direct object over the indirect object should never be allowed. However, we previously saw cases in which inverse scope was allowed (in section 1.3.2). In this section we will discuss a very different account of Scope Freezing, namely Goldberg (2006), which relates constraints on scope interaction to the relative information-structural status of the two objects in the double-object construction. This account can easily accommodate the facts presented in section 1.3.2.

Goldberg (2006) argues for an account in which scope assignment is strongly correlated with information structure and particularly topicality. Goldberg follows Lambrecht (1994) and assumes that the topic of a sentence is a "matter of [already established] current interest which a statement is about and with respect to which a proposition is to be interpreted as relevant". In other words, the topic is old information and the statement in which it occurs is evaluated with respect to the topic. Goldberg assumes that in languages like Dutch and English the subject of a sentence is the default or primary topic (Chafe 1987; Lambrecht, 1994; Langacker, 1987; MacWhinney 1977). However, Goldberg further argues that in double-object constructions the indirect object functions as a secondary topic (see also Dryer, 1986; Givón 1979, 1984; Langacker, 1987; Van Hoek, 1995). Goldberg presents a selection of evidence in favour of this secondary topic status. First of all, in corpus studies it was found that the recipient argument in the double-object construction tends to be expressed as an (unstressed) third person pronominal or a definite DP (for example: 'give *me* the book' or 'give *the* man a pencil'). In other words, they generally encode 'old' information and do not introduce new referents (Thompson, 1990; Collins, 1995; among others). Second, recipients in the double-object constructions tend to be animate and carry an existence presupposition (Polinsky, 1998). Both of these properties are known to be correlated to topicality as well (see Boeck, Loebell and Morey, 1992 for animacy, and Strawson, 1964 for the existence presupposition). Third, recipients do not seem to be part of the focus domain of a sentence. A diagnostic for determining whether an

element is part of the focus domain is whether it can be negated easily (Erteshik-Shir, 1979). Consider sentence (40):

- (40) Speaker A: She gave her a ball.
 Speaker B: # No, him.
 OK No, a balloon.

When we attempt to negate the recipient, this is not acceptable. However, when we negate the theme argument (that is, the direct object) which expresses new information and is part of the focus domain, the negation is acceptable. All the above arguments suggest that the indirect object in a double-object construction has topic status.

Goldberg assumes that subjects are primary topics and recipients are secondary topics, while theme arguments or oblique arguments (e.g. the PP in a *to*-dative) are not topical and are generally available to introduce new information. As such, she proposes a hierarchy of topicality for ditransitive constructions:

- (41) agent (subject)>> recipient >> (oblique >> theme).

Ioup (1975) already argued that the element that is the most topical in a sentence has the greatest tendency for wide scope. The assumption that relative topicality determines whether an element can take wide scope, this predicts that subjects generally take wide scope over quantified expressions that function as the recipient or theme, and that quantifiers that function as recipients tend to take wide scope over theme arguments. This account thus correctly predicts that in a double-object construction the indirect object is interpreted with wide scope over the direct object, and thus captures Scope Freezing.¹³

However, on this account Scope Freezing is a relatively soft constraint, and no stronger than the preference adults have for a wide scope interpretation of the subject over a wide scope interpretation of the direct object (Kurzman and MacDonald, 1993). However, whereas inverse scope of the direct object of a monotransitive construction over the subject of that construction seems to be relatively accessible, inverse scope of the direct object of a double-object construction over the indirect object is much harder to achieve. Scope Freezing thus appears to be a relatively strong constraint. I will argue that this is because in the case of ditransitives there is a choice

¹³ For examples like (32), in which the direct object scopes over the subject, we have to assume that in these cases the topicality of the subject is reduced, making inverse scope more accessible. This could be because the subject contains a lexical item which is less suitable as a topic (like *some* or in the case of (32) *at least two*).

between two constructions. We can either express a proposition as a *to*-dative as in (42a) or as a double object construction (42b):

- (42) a. The car salesman showed every car to a man.
 b. The car salesman showed a man every car.

When using the double-object construction the choice of this construction indicates that the speaker wants to structure the information in a certain way. That is, when using a double-object construction a speaker signals that the new information he wants to convey is not new information concerning the recipient of the action, because if he did, he would have used a *to*-dative. He intends the recipient of the action to be ‘given’ information that is already part of the discourse context. The recipient is intended to be topical and thus to take wide scope if it is a quantified element.

While relative topicality strongly predicts the predominant scope assignment, it is relatively easy to accommodate other effects on quantifier scope. For instance, certain lexical items may be more topical than others. Non-specific quantifiers like *some man or other* are not very suitable as topics, hence when such a quantifier occurs in the indirect object position inverse scope of the direct object may be facilitated. Quantifiers like *each* seem to be discourse-linked and as such are more suitable as topics. When such a quantifier occurs in the direct object, the direct object may be interpreted as more topical, which may again facilitate inverse scope of the direct object over the indirect object.

In sum, in this section we have introduced Goldberg’s Information-Structural account of Scope Freezing. In this account it is argued that in the double-object construction the indirect object generally takes wide scope over the direct object because the indirect object is interpreted as a secondary topic. We have argued that the constraint is generally perceived as a strong constraint, because if a speaker wanted to utter a statement in which the recipient was not topical, and thus would not take wide scope, he could have uttered a different construction, namely the *to*-dative. However, this account does allow inverse scope in situations in which the recipient is for some reason not interpreted as the secondary topic.

With regard to the acquisition of Scope Freezing, Goldberg’s predictions are somewhat weaker than the predictions of Bruening’s syntactic account. We know that five-year olds have not acquired all of the intricacies of information structure. Narasimhan and Dimroth (2008), for instance, showed that while adults tend to order old/accessible information before new information, three- to five-year old (German-speaking) children have the opposite preference. In addition, we know that children often

overuse pronouns and definite markers (Hickman 1982; Maratsos, 1976; Stenning and Mitchell, 1985, among other). Adults generally use pronouns and definites to refer to information that is already part of the discourse model. Children, however, often use these lexical items to introduce new elements, again suggesting that they do not have targetlike command of discourse-related phenomena. Goldberg's account of Scope Freezing predicts that scope freezing should be acquired as soon as children have acquired the fact that the indirect object in a double-object construction is the secondary topic of the sentence and thus should take wide scope over DPs that are lower on the topicality-scale. Since discourse-related skills are often acquired late, Scope Freezing may also be acquired late, though we do not know exactly when. Despite the fact that this account does not make strong predictions concerning the age at which children are expected to have acquired the constraint, it is this account of Scope Freezing that we will assume throughout most of the dissertation.

1.5 Outline of the Study

As stated above, in this study we are mainly concerned with children's interpretation of double-object constructions in which, for adults, scope interaction is restricted. We will evaluate and attempt to explain the errors children make in their interpretation of double-object constructions with an indefinite direct object and a universally quantified direct object. Most attention will be paid to a single non-targetlike response pattern, namely the Reverse Pattern. Below a short overview is presented of the topics that are dealt with in the following chapters.

1.5.1 Chapter 2: The Reverse Pattern

Chapter 2 will present a selection of research which shows that four- to six-year old Dutch and English-speaking preschool children do not interpret double object constructions of the form *The bear gave a hedgehog every cake* the way adults do. They not only allow the interpretation that the Frozen Scope Constraint blocks, but they also reject the one interpretation of the target sentence that adults allow. In doing so, children's performance pattern is the exact reverse of the target-like response pattern. This performance pattern will be named the Reverse-pattern.

1.5.2 Chapter 3: The Indefinite

This chapter will explore the possibility that the Reverse-pattern relates to incomplete acquisition of the meaning of the indefinite article *a/an* (Su (2001b)'s Lexical Factor Hypothesis) or incomplete acquisition of the meaning of singular indefinites in general (Krämer (2000)'s The Non-Integration Account, and the Singleton Restriction Hypothesis). The results will show that the Reverse-pattern is not caused by children's non-targetlike interpretation of indefinites. The Reverse-pattern is observed with a variety of singular indefinites (contra Su's Lexical Factor Hypothesis). Furthermore, we will show that children are able to interpret indefinites in a targetlike way in sentences that do not contain universal quantification.

1.5.3 Chapter 4: The Universal Quantifier

In chapter 4 we will investigate whether children's interpretation of universal quantification could be the cause of their non-targetlike performance. We first investigate whether the Reverse-pattern is in fact limited to universal quantifiers or also occurs with quantifiers which share certain properties with them (for instance, numerals like *three*). This will be followed by an investigation into the role of distributive universal quantification. We will propose the Distributivity Hypothesis, which predicts the Reverse-pattern to be limited to sentences containing distributive universal quantification, a prediction that will be tested in a Truth-Value Judgment experiment. We will show that the Reverse-pattern disappears when children are presented with double-object constructions with a numeral or the collective universal quantifier *alle* ('all') heading the indirect object DP. These results will be shown to provide evidence in favour of the hypothesis that the Reverse-pattern relates to children's interpretation of distributivity.

1.5.4 Chapter 5: Distributivity

In chapter 5 the property of distributivity will be examined. After introducing the notion of events and event structure, we will examine Tunstall's (1998) Event-Distributivity Condition. This condition states that the situations in which quantifiers like *every* are used need to have an (at least) partially distributive event structure. We will investigate the validity of this account in a picture-selection task and show that adults do not require partial distributivity but rather full distributivity. Based on these results we will propose two versions of what we will name the Prototypical

Distributivity Hypothesis. We will argue that both children and adults associate distributive universal quantifiers with an event structure in which there is a one-to-one correspondence between the objects in the domain of the universal quantifier and a set of (sub)events. However, whereas adults can accommodate deviations from this pattern, children cannot. However, the results of a Truth-Value Judgment experiment will show that children not only rely on prototypical distributivity, but also on what we will call Full Set Linking.

1.5.5 Chapter 6: An Account

In the final chapter we will first summarize what we have learned about the Reverse-pattern and we will subsequently propose an account which incorporates both prototypical distributivity and Full Set Linking. We will assume that for both children and adults the use of a distributive universal quantifier signals a prototypically distributive event. Deviations can be accommodated and the contexts can thus be reanalyzed in appropriate ways. However, children and adults differ in the way they evaluate whether an event structure satisfies prototypical distributivity and the way they proceed to accommodate deviations from the prototypically distributive event structure. It is the strategy that children use that leads them to rely on Full Set Linking. That is, it is this strategy which favours situations in which the elements of two distinct sets are exhaustively linked. In addition we will investigate what our results tell us about children's acquisition of the Scope Freezing Constraint and how children eventually learn to evaluate the event structures in a targetlike manner.

Chapter 2

The Reverse-Pattern

2.1 Introduction

As shown in the previous chapter, for adult native speakers of English the double-object construction in (1a) is unambiguous. The only possible interpretation of this sentence is the interpretation where a single hedgehog gets every cake. The interpretation where every cake is given to a different hedgehog, an interpretation derived through wide scope of the universal quantifier, is unavailable. This phenomenon is generally known as SCOPE FREEZING or the FROZEN SCOPE CONSTRAINT (see Larson, 1990; Bruening, 2001; Naganishi, 2001a,b). This same constraint holds in all languages which have a double-object construction (or equivalent), including Dutch (1b) and Chinese (1c).¹⁴

- (1) a. The bear gave a hedgehog every cake.
 $(\exists > > \forall, * \forall > > \exists)$
 b. *De beer heeft een egel elke taart gegeven.*
 the bear has a hedgehog every cake given
 ‘The bear gave a hedgehog every cake’.
 c. *laoshi jiegei yi-ge nanhai mei-ben shu*
 teacher lend-to-a-CL boy every-CL book.
 ‘The teacher lent a boy every book’.

By contrast, constructions corresponding to the English *to*-dative construction are ambiguous in these languages, see (2).¹⁵

¹⁴ Though in all three languages scope is frozen in double-object constructions, this does not necessarily mean that the underlying constraint is the same in all cases. However, in this study we will assume that it is.

¹⁵ Although in this specific case it is actually debatable whether this really is a case of scope ambiguity. The possible interpretations derived through wide-scope of the lower quantifier (e.g. the indefinite) form a subset of the set of possible interpretations derived through wide scope of the c-commanding quantifier (e.g. the universal quantifier). It is thus impossible to tell whether the interpretation where a single hedgehog is given every cake is derived through wide scope of the indefinite or through wide scope of the universal quantifier. However, *to*-datives in which the indefinite precedes the universal quantifier are ambiguous too. The sentence *The bear gave a cake to every fox* either means that every fox is given a different cake,

- (2) a. The bear has given every cake to a hedgehog.
 ($\forall > > \exists, \exists > > \forall$)
- b. *De beer heeft elke taart aan een egel gegeven.*
 the bear has every cake to a hedgehog given
 ‘The bear gave every cake to a hedgehog’.
- c. *laoshi jie-le mei-ben shu gei yi-ge nanha.*
 teacher lent-ASP every-CL book to a-CL girl
 ‘The teacher lent every book to a girl’

In the next sections we will review evidence which shows that children do not have knowledge of the Frozen Scope constraint. Not only do some children allow both the distributive interpretation and the surface scope interpretation of the sentence in (1a) (henceforth called the AMBIGUITY-pattern), but there is also a large group of children who allow the blocked interpretation of sentence (1a), but deny that sentence (1a) is true in a situation in which a single hedgehog gets every cake. Since this latter pattern is the REVERSE of the targetlike pattern for double-object datives, this pattern will be referred to as the Reverse-pattern throughout this dissertation. In section 2.3 it will be shown that this response pattern is not just observed with dative constructions, but also with transitive sentences containing an indefinite subject and a universal quantifier. After a review of previous research on the acquisition of targetlike scope relations in dative constructions and simple transitive sentences, a new experiment on the acquisition of scope freezing by Dutch-speaking preschool children will be presented. The findings from previous research and the results of our own experiment will show that the Reverse-pattern is a robust occurrence in Dutch and English child language. Subsequently, three possible explanations of the Reverse-pattern will be considered: (i) the Reverse-pattern is caused by a non-targetlike scope construal, (ii) the Reverse-pattern results from incomplete acquisition of the syntactic structure of the constructions under consideration, and (iii) the Reverse-pattern is not a new non-adultlike pattern, but should in fact be (partly) subsumed under another well-known child “error”, namely the Exhaustive Pairing phenomenon (first noted in Inhelder and Piaget, 1964).

Section 2.2 will review previous research on the acquisition of scope freezing in double-object constructions. This is followed by a review in section 2.3 of the literature on the acquisition of targetlike scope relations in transitive sentences in Dutch and English. In section 2.4 a new experiment

or that a single cake is given to every fox (on different occasions). This seems to be the case for all three languages discussed in section 2.1.

on the acquisition of scope freezing in Dutch will be presented. Section 2.5 discusses three possible explanations of children's non-targetlike performance, though it will mainly focus on the Reverse-pattern. Finally, in section 2.6 we summarize the results.

2.2 The Acquisition of Frozen Scope in Dative Constructions

As we have seen in examples (1a) and (1c) in the previous section, both English and Chinese double-object constructions are unambiguous. The only possible interpretation of these sentences is the interpretation derived through wide scope of the existentially quantified DP in the indirect object position. In contrast, in both languages *to*-datives are ambiguous (see (2a) and (2c)). Su and Crain (2000) and Su (2001b) report an experiment which tested Chinese-speaking and English-speaking children's interpretations of sentences like (1) and (2).¹⁶

Su and Crain (2000) and Su (2001b) presented 24 English-speaking preschool children (mean age 5;3) and 27 Chinese-speaking preschool children (mean age 5;7) with a punishment-reward version of the Truth-Value Judgment task (Crain and McKee, 1985). In this task children were presented with short stories that were acted out with toys and props. After each story a puppet was invited to tell the child what he thought had happened. In response, the puppet would utter a statement like (3a) or (3b). The child was instructed to feed the puppet something nice if she thought the puppet was right, and to force the puppet to do push-ups if she thought the puppet was wrong.

- (3) a. Snow White gave a lady every flower.
b. Snow White gave every flower to a lady.

The sentences in (3) were presented in two distinct situations: a situation in which a single lady (out of three ladies) was given all of the flowers, henceforth called ONE>ALL event, or in a situation in which every flower was given to a different lady, which will be referred to as an ALL>ONE event.¹⁷ See figure 1 below for a graphic representation of the event types.

¹⁶ Su (2001a) and Su (2001b) also report a second experiment on children's interpretations of double-object datives and *to*-datives. The results of the second experiment replicate the results of the experiment discussed in this section.

¹⁷ In other research these event types are generally called DISTRIBUTIVE (for ALL>ONE events) and COLLECTIVE (for ONE>ALL events), see for instance Brooks and Braine (1996) and Brooks et al. (2001). However, I will refrain from

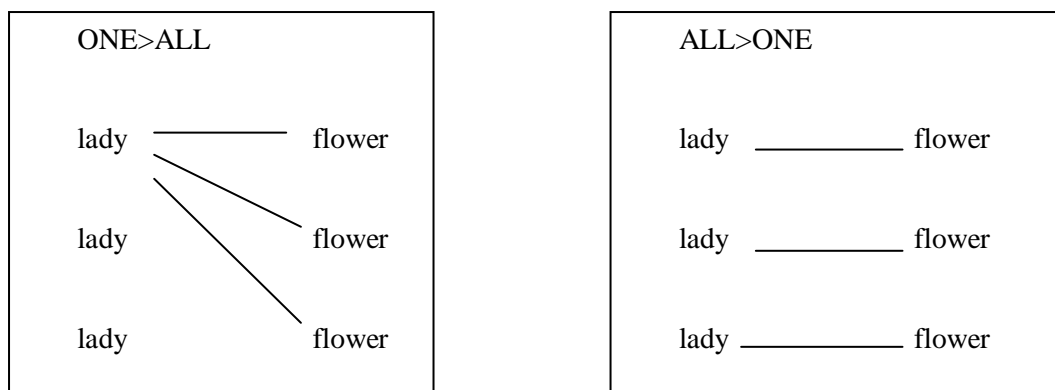

Figure 1: Event-Types

If children were to perform targetlike, they should reject sentence (3a) for an ALL>ONE event and accept it for a ONE>ALL event. Furthermore, they should accept (3b) in both of the above-mentioned situations. A sample story (in English) is presented below (Su, 2001b: 50-51):

Characters and Crucial Props

Snow White, three ladies, and two boys

Three flowers, three balloons, three toys swords, and one toy gun

Experimenter: Snow White is having a Halloween party at her house, but some of her guests don't know how to dress up for the party.

Lady 1: Snow White, we don't know how to dress up for your party, can you help us?

Snow White: No problem. I have a lot of great stuff for a party. Let me check what I have. Here I have three beautiful flowers, three

using these terms to describe the types of event tested in the experiments I discuss because (i) both event types can in fact be construed to be distributive as for each individual element of the restriction set of the quantifier the property denoted by the predicate holds (e.g. in ONE> ALL events every flower has the property of being given to a lady by Snow White. It just happens to be the same lady for all of the flowers), and (ii) I want to reserve the term collective for situations which cannot in any way be construed as (fully) distributive. A true collective event (see Bennet, 1974) is an event in which a collective or a group has a certain property, but not all individuals in that group necessarily do. Consider the sentence *The boys are replacing the light bulb*. This sentence is true if a group of boys is working towards that goal, but only a single boy is actually performing the action of replacing the light bulb. In chapter 4 (section 4.4.2) we will refine the notion of collectivity, and distinguish collective-action events and collective-responsibility events.

- balloons, three swords, and a toy gun. I think each of you ladies can have a balloon. They look good.
- Lady 2: No I want a flower. The balloons look more like children's things.
- Lady 3: Yes, I agree with you. I want a flower too; the balloons should be for kids.
- Lady 1: I want a flower too. They are really beautiful.
- Snow White: You can have this flower. You can have this one. And this one is yours. (= ALL>ONE event) How about you boys?
- Boy 1: I want the toy gun. I want to dress up like a cowboy.
- Snow White: And you, little boy? Do you want the three balloons? You can dress up like a clown.
- Boy 2: The balloons look great. But, I like the three swords more than the balloons. I can dress up like a knight to fight with the enemies (=ONE>ALL event).
- Lady 1: If no one wants the balloons, I can have them. I think it will be fun for me to dress up like a clown with the balloons.
- Puppet: Control (false): Snow White gave a boy every balloon
 DO-dative (true): **Snow White gave a boy every sword**
 DO-dative (false): **Snow White gave a lady every flower**
- or
- to*-dative (true): **Snow White gave every sword to a boy.**
to-dative (false): **Snow White gave every flower to a lady.**

In the sample story both the ONE>ALL event and the ALL>ONE event were intertwined in a single story involving many characters and props. For the double-object datives children were presented with four ONE>ALL events, and two ALL>ONE events. For the *to*-datives children were presented with two instances of each event-type.

The percentages of yes-responses children and adults provided in table 1 below:

Group	Language	Double-object construction		<i>to</i> -dative	
		ONE>ALL	ALL>ONE	ONE>ALL	ALL>ONE
Children	English	45%	72%	50%	77%
	Chinese	97%	7%	98%	28%
Adults	English	100%	0%	97%	72%
	Chinese	91%	22%	95%	21%

Table 1: Percentage YES-responses per condition

When presented with an ALL>ONE event (e.g. each lady is given a flower) English-speaking children accepted the (double-object) test sentence 72 percent of the time. Furthermore, they only accepted the test sentence 45 percent of the time in a situation corresponding to the ONE>ALL event (a single boy got all three swords). In other words, their performance was decidedly non-targetlike. English-speaking adults always rejected the test sentences for ALL>ONE events and always accepted them for ONE>ALL events. The adults thus performed as expected.

The Chinese-speaking children performed significantly more targetlike than the English-speaking children. They accepted test sentences 97 percent of the time for ONE>ALL events (Chinese-speaking adults did so 91 percent of the time). In addition, they rejected the test sentences on average 93 percent of the time in the ALL>ONE event (Chinese-speaking adults did so 78 percent of the time).

When presented with the ambiguous *to*-datives only half of the English-speaking children accepted the sentences as a true description of a ONE>ALL event, while 77 percent accepted it as a description of an ALL>ONE event. Chinese-speaking children again performed targetlike, though surprisingly both adults and children accepted the interpretation where a single lady is given every flower (ONE>ALL) a little over 20 percent of the time, a much lower percentage than expected.

The individual results show that when presented with double-object datives 10 English-speaking children accepted the illicit interpretation and rejected the targetlike interpretation. 5 performed targetlike and 4 judged both test sentences to be true. The results for 5 of the children were inconsistent. For the *to*-datives 11 children rejected the test sentences in a ONE>ALL event, and accepted them in an ALL>ONE event. 4 children accepted the test statements in both event-types, which constitutes targetlike performance. 4 children rejected the test statements for ALL>ONE events and accepted them for ONE>ALL events. The results of the remaining children were difficult to interpret. In other words, when judging double-object datives and *to*-datives almost half of the English-speaking children consistently showed a performance pattern that is the exact opposite of the targetlike-pattern (for double-object datives). None of the Chinese-speaking children ever consistently showed this performance pattern.¹⁸

To summarize, the results show that though Chinese-speaking children behave targetlike in their interpretation of sentences like (3a,b), English-speaking children do not. That is, many children reject the test sentence for a ONE>ALL event, while they should judge the sentence to be

¹⁸ However, one Chinese child showed this pattern some of the time.

true in that situation, and they accept the test sentence for an ALL>ONE event, even though in the case of (3a) this is an illicit interpretation. Since in the case of double-object datives child performance is the opposite of adult performance, this performance pattern is called the REVERSE-PATTERN. This, however, is not the only non-targetlike pattern which was observed. Out of the 27 children, 4 consistently judged test statements to be true for both event types, and show an Ambiguity-pattern. In this chapter we mainly focus on explaining the Reverse-pattern, and not the Ambiguity-pattern, but we will come back to the latter in forthcoming chapters. Before investigating the source of the Reverse-pattern, a variety of studies on the acquisition of frozen scope in Dutch transitive sentences will be reviewed. It will be shown that the non-targetlike patterns we identified above are not only found with dative constructions, but are also observed with monotransitive sentences.

2.3 (Frozen) Scope in Simple Transitive Sentences

2.3.1 Dutch

As shown in chapter 1 (section 1.3.2), Dutch is relatively scope-rigid. For most native speakers of Dutch, the only possible interpretation of sentence (4) is the surface scope interpretation. Inverse scope is ruled out.

- (4) *Een vogel heeft elke bosbes opgegeten.* (Philip, 2005)
 a bird has each blueberry up.eaten
 ‘A bird ate each blueberry’.

In an experimental setting, Dutch-speaking adults generally judge sentence (4) to be true in a situation in which a single bird has eaten all of the blueberries, while they tend to reject the sentence when each blueberry is eaten by a different bird (Philip, 2005: 84 percent rejections; Hendriks, Koops van ‘t Jagt and Hoeks, to appear: 79 percent rejections). In other words, for most adults transitive sentences like (4) with an indefinite subject and a universally quantified object are subject to a scope constraint, which we will refer to as the SPECIFICITY CONSTRAINT.

Children, however, do not acquire this constraint at an early age. The youngest age group (mean age 6;5) in Philip’s study accepted sentences like (4) in distributive ALL>ONE events about 33 percent of the time, and differed significantly from adults who only did so 16 percent of the time. In fact, Philip found that even 12-year old children differed significantly from adults in their interpretation of sentences like (4). Philip (2005)’s results also show that at an early stage of development a group of children seemed to reject a wide scope interpretation of the indefinite. About 30 percent of the

6-year-olds and 16 percent of the 7-year-olds rejected the test statement when a single bird had eaten all of the blueberries. We do not know whether these children were children that accepted ALL>ONE events, so we do not know whether these children show the Reverse-pattern, but the results are suggestive.

However, there is more experimental evidence of children's late acquisition of the scope constraint in Dutch transitive sentences. Hendriks, Koops van't Jagt and Hoeks (to appear) report that 89 percent of their participants (mean age 5;11) accepted test sentences like (4) in ALL>ONE events. Furthermore, Philip and Coopmans (1995) tested Dutch-speaking children's interpretation of sentences like (5):

- (5) *Draagt een schildpad iedere vogel?*
 carries a turtle every bird
 'Does a turtle carry every bird?'

These sentences were presented in two distinct situations, a situation in which a single turtle was carrying every bird (e.g. a ONE>ALL event) and a situation in which every bird was carried by a different turtle (an ALL>ONE event). The participants in this study were 93 Dutch-speaking children (3-8 years old). This study used static pictures depicting the events of which a yes-no question was asked.

For Dutch-speaking children performance on both conditions was strikingly non-targetlike. Children gave a targetlike yes-response on ONE>ALL events only 16 percent of the time, and showed non-targetlike performance up to at least age 8. Furthermore, they gave non-targetlike yes-responses about 90 percent of the time for the ALL>ONE event. A large proportion of the children thus accepted ALL>ONE events and rejected ONE>ALL events and thus seemed to show a response pattern which is similar to the Reverse-pattern. When Dutch-speaking adults were presented with the test sentence in a situation in which a turtle was carrying all the birds on its back, they judged the sentence to be false an unexpected 26 percent of the time.¹⁹

The results of the above experiments first of all show that the Specificity Constraint operative in Dutch transitive sentences with an indefinite subject DP is acquired late, and second, they suggest that some children may be showing a performance pattern which resembles the Reverse-pattern.

¹⁹ However, the adults correctly rejected sentences in ALL>ONE type events 94 percent of the time.

Finally, non-targetlike performance may not be limited to sentences with an indefinite subject and a universally quantified object. Drozd and Van Loosbroek (2006) presented 26 four-year olds (mean age 4;4) and 26 five-year olds (mean age 5;6) with questions like (6) in a situation in which all of the boys were riding a single elephant (while two elephants were riderless).²⁰

- (6) *Rijdt iedere jongen op een olifant?*
rides every boy on an elephant
'Does every boy ride an elephant?'

The 4-year olds said 'yes' in such a situation only 35 percent of the time. The 5-year olds did so only 48 percent of the time. In other words, many children (65 percent of the 4-year-olds and 52 percent of the 5-year olds) rejected (6) as a description of an event in which all of the boys are riding one elephant (a ONE>ALL-type event).

To summarize, a scope constraint is operative in Dutch simple transitive sentences with an indefinite subject DP which prohibits inverse scope of the direct object quantifier over the indefinite in subject position. Some children, however, not only seem to allow inverse scope (e.g. they accept a distributive interpretation of the test sentences), but may also reject the surface scope interpretation of the test sentences. These children show a performance pattern which is highly similar to the Reverse-pattern that Su and Crain (2000) and Su (2001b) observed with dative constructions.

2.3.2 English

2.3.2.1 Previous Research

English differs from Dutch in allowing sentence (7) to have multiple interpretations.²¹ It allows both wide scope of the indefinite and wide scope of the universal quantifier.

²⁰ We do not know how these children would interpret similar sentences in ALL>ONE events. Drozd and Van Loosbroek did test children's interpretation of the question in (6) in a distributive situation. However, their distributive situation was a typical Exhaustive Pairing context with every boy riding an elephant and one elephant left over. We know from the literature that many children show the Exhaustive Pairing error in such situations, and thus judge the sentence to be false (see section 2.5.3 as well as the introduction to chapter 1). Therefore, the context tested by Drozd and Van Loosbroek is not directly comparable to the ALL>ONE events used in the other experiments presented in this section.

²¹ Even though most linguists hold that these sentences are ambiguous in English, psycholinguistic research has shown that adult speakers have a strong preference for

- (7) A turtle is carrying every bird.

Philip and Coopmans (1995) presented 11 English-speaking children (mean age 6;6) with questions like *Is a turtle carrying every bird?* An English-speaking child performing targetlike should answer ‘yes’ to (7) both when a single turtle is carrying every bird (e.g. the ONE>ALL event), and when every bird is being carried by a different turtle (e.g. the ALL>ONE event). Philip and Coopmans found that English-speaking children gave a targetlike YES-response for ONE>ALL events 68 percent of the time, and judged the test statement to be true of ALL>ONE events 91 percent of the time. These results suggest that English-speaking children perform significantly more targetlike than the Dutch-speaking children on ONE>ALL events (see the results of the Dutch participants discussed in section 2.3.1). However, note that on 32 percent of the trials children judged the test sentence to be false of ONE>ALL events. There does thus seem to be a group of children who could show the Reverse-pattern.

Su (2001b) tested 20 children (mean age 5;6) on their interpretation of sentences like (8):

- (8) A boy jumped over every fence.

This test sentence was presented in a context in which three boys are in a jumping contest in which the goal is to jump over three fences. Boy 1 tries to jump over the fences, but falls. Boy 2 also tries, and fails. Boy 3 jumps over all three fences. Children judged sentence (8) to be true of this story 83 percent of the time. Though most children must have performed targetlike, children did judge the test sentences to be false of ONE>ALL events on 17 percent of the trials.²² However, we lack information about the way these children interpret sentences like (8) in ALL>ONE events.

Rakhlin (2007) did present children with both event-types. She tested 16 English-speaking children (mean age 4;6) on their interpretation of sentences like (9):

- (9) A girl tasted every cake.

the surface scope interpretation, e.g. the interpretation where the indefinite takes wide scope (see Kurzman and MacDonald, 1993)

²² Su does not report any justifications children may have given for their rejections of test sentences in ONE>ALL events.

When presented with this sentence in a situation with three girls and a boy and three cakes, and in which one of the girls tasted every cake (while the other girls did not taste any cake), 13 children accepted the test sentences in this type of event, one rejected the test sentences, and the performance of two of the children was inconsistent. When these children were presented with an ALL>ONE-type event six out of sixteen children accepted test sentences in this type of event, three did so some of the time, and the other seven rejected them. The one child who rejected the test sentences in ONE>ALL events did accept the test sentences when presented in an ALL>ONE event (each girl tasted a cake). This child thus seems to show a Reverse-pattern. However, the children in this experiment performed significantly more targetlike than the Dutch-speaking children discussed in section 2.3.1.

2.3.2.2 A Pilot Study on English

To further investigate the question whether English-speaking children also show the Reverse-pattern when interpreting simple transitive sentences with an indefinite subject and a universally quantified object, 20 English-speaking children in Canada (age range 3;7-5;7, mean age 4;9) were presented with a short Truth-Value Judgment task testing sentences like *A cat ate every fish*. This type of test sentence was again presented in two event-types, e.g. a ONE>ALL event (one cat eats all of the fish) and an ALL>ONE event (each of three cats eats one fish, exhausting the set of fish). There were thus two separate conditions. Children were only presented with one instance of each condition.

Of the 20 children who were presented with the materials, 5 showed the Reverse-pattern. That is, they rejected the test sentence when one cat gets all of the fish, while they accepted the test sentence when every fish is eaten by a different cat. Of the remaining children only 2 judged both sentences to be true, the performance pattern that would be predicted if children were to perform targetlike (but see footnote 21). Most of the children (N=10) rejected the test sentence in an ALL>ONE event, while they accepted it in a ONE>ALL event. These children only seem to allow wide scope of the existential quantifier. When 8 English-speaking adults (mean age 21;6, all students) were presented with these test materials, half of them also performed this way. For many English-speaking adults sentences like *A cat ate every fish* are not ambiguous at all (see footnote 21).

This short review of the literature and the results of the pilot experiment make clear that a type of Reverse-pattern is observed to some degree with English simple transitive sentences with an indefinite subject and a universally quantified object.

2.4 The Acquisition of Frozen Scope in Dutch: An Experiment

In the previous sections, research on the L1-acquisition of (frozen) scope in ditransitives and simple transitive sentences was reviewed. Non-targetlike behaviour was observed for all constructions. In particular, it was observed that a subgroup of 4-6 year old children allow a distributive interpretation of the test sentences, but also reject the interpretation which corresponds to wide scope of the indefinite. This group of children was said to show the Reverse-pattern. So far, the evidence for the Reverse-pattern is based on some data from the acquisition of English ditransitive (and transitive) sentences and some suggestive data from Dutch transitive sentences. This section will present an experiment in which both types of constructions are tested in Dutch. This experiment aims to find out (i) whether the Reverse-pattern is also observed in Dutch ditransitives (including Dutch scrambled *to*-datives), (ii) whether the Reverse-pattern is indeed also observed in Dutch transitive sentences, and (iii) whether the Reverse-like patterns observed for the transitive and ditransitive constructions are in fact instances of the same phenomenon.

2.4.1 Participants

In this experiment 40 Dutch-speaking preschool children (age range 4;2 - 6;10, mean age 5;5) were presented with a Truth-Value Judgment task. This group consisted of 17 girls and 23 boys, who were tested at two primary schools in the Utrecht area of the Netherlands. A group of 10 adults (age range 19-50, mean age 32), all non-linguists, were also presented with the same materials. This group consisted of 7 men and 3 women.

2.4.2 Design and Procedure

The children participating in this experiment were tested on a variety of sentences in a Truth-Value Judgment task with picture-stories (see Gordon, 1996 for an overview of the Truth-Value Judgment Paradigm). The experiment was administered by two experimenters. One of the experimenters played the role of storyteller. This experimenter sat next to the child and read the stories out to her, while pointing at relevant events in the pictures. The second experimenter manipulated the puppet and recorded the child's responses on an answer sheet. The children were told in class that the puppet (a dinosaur in an egg) was very bad at listening to stories. This was demonstrated by telling him a short story and then asking him to tell the class what had happened in the story. The children were asked to help teach

the puppet to listen to stories better. They were then tested individually in a quiet corner of the school. After each (part of a) story the puppet would attempt to recount what had happened in the story.²³ When children judged one of the puppet's statements to be false, they were asked to explain to the puppet why he was wrong.

During the experiment children were presented with multiple test and control conditions. The Indefinite Subject (IS)-conditions tested simple transitive sentences with an indefinite subject and a universally quantified object. An example of a sentence used in this condition is presented in (10).

- (10) *Een kat heeft elke worst opgegeten.*
 a cat has every sausage up.eaten
 'A cat ate every sausage.'

A sentence like (10) was presented in two distinct situations. When presented after a situation in which each sausage is eaten by a different cat (an ALL>ONE event), adults should judge this sentence be a false description of the context. When presented after a situation in which a single cat is eating all of the sausages (a ONE>ALL event), it should be judged true. There was only one trial of the IS-ALL>ONE and the IS-ONE>ALL conditions.²⁴

The experiment also tested children's interpretation of ditransitive sentences with a universally quantified direct object and an indefinite indirect object. In Dutch there are three ways of expressing ditransitive predicates. All three possible dative constructions were included in the experiment. Examples of test sentences are presented in (11):

²³ All test sentences containing universal quantification were uttered with neutral intonation. Care was taken not to stress either the indefinite or the universal quantifier.

²⁴ All of the Dutch test sentences used present perfect tense. This tense was felt to be most natural. Since in nearly all cases the test sentences described a completed event, the use of this tense was felicitous. The only exception occurred in the story testing the IS-conditions, in which the final scene of the story showed the characters in the process of doing something (that is, the cats are in the process of eating). In this case the use of present perfect is less felicitous, which could have introduced a confounding factor. However, if it was, then it should have affected both of the IS-conditions to the same degree, and any differences we may observe between the two conditions should still stand.

- (11) a. DO-dat ($\exists > > \forall$, $*\forall > > \exists$)
De beer heeft een egel elk stuk taart gegeven.
 the bear has a hedgehog every piece (of) cake given
 ‘The bear gave a hedgehog every piece of cake’
- b. PP-Dat ($\exists > > \forall$, $\forall > > \exists$)
De beer heeft elk stuk taart aan een egel gegeven.
 the bear has every piece (of) cake to a hedgehog given
 ‘The bear gave every piece of cake to a hedgehog’
- c. SPP-Dat ($\exists > > \forall$, $*\forall > > \exists$)
De beer heeft aan een egel elk stuk taart gegeven
 the bear has to a hedgehog every piece (of) cake given

The double-object (DO) dative in (11a) only allows a wide scope interpretation of the existential over the universal quantifier. The PP-Dat construction in (11b), a *to*-dative, is ambiguous between a wide and a narrow scope reading of the universal quantifier. The SPP-Dat sentence in (11c) is a construction which is unavailable in English, namely a construction in which the PP (e.g. the *to*-phrase) has moved (or scrambled) to a position to the left of the indefinite.²⁵ SPP-dat sentences are unambiguous. Just like DO-dat sentences they only allow wide scope of the indefinite.²⁶

The test sentences were all presented in both a ONE>ALL and an ALL>ONE event. There were thus six distinct conditions. When the sentences in (11) were presented in an ALL>ONE event, this would be an event in which each hedgehog was given a different piece of cake, exhausting both the set of pieces of cake and the set of hedgehogs. The ONE>ALL event would be an event in which a single hedgehog (out of a set of three hedgehogs) was given all of the pieces of cake.

Children were only presented with one dative construction, so either DO-Dat, PP-Dat or SPP-Dat. However, children were presented with 6 instances of this dative construction: half the time as a statement describing a

²⁵ The acronym SPP stands for Scrambled Prepositional Phrase. Scrambling is a movement operation that in Dutch generally only reorders the relative order of adjuncts and arguments. However, in the *to*-dative two arguments are reordered. One could argue that scrambling is not a correct term for the movement operation that applies in this sentence-type. However, for the purpose of this study I will continue to refer to this dative construction as a Scrambled Prepositional Dative.

²⁶ A question is whether the constraint that applies in SPP-sentences is the same as the constraint that applies in double-object constructions. The Information-Structural Account of Scope Freezing can accommodate both constraints, as in both cases the indirect object, whether it is a PP or a DP, occurs in a position which is associated with high topicality.

ONE>ALL event and half the time as a statement describing an ALL>ONE event.²⁷ The test statements were spread out over three stories in which three different predicates were tested, e.g. *geven* ('to give'), *verkopen* ('to sell') and *brengen* ('to bring').

The indefinite in the test statement needed to be interpreted as referring to a single individual in ONE>ALL events, and to multiple individuals in ALL>ONE events. In ONE>ALL events the indefinite was felicitous under its partitive interpretation, as the indefinite article *een* referred to a single (non-unique) individual from a set of similar individuals. The indefinite was also felicitous in ALL>ONE events as all of the individuals in the source set of the indefinite were equally salient. There was thus no bias towards interpreting the indefinite DP headed as referring to a specific individual. In all test statements the universal quantifier *elk* ('each/every') was used.²⁸

Besides the test items, the experiment also contained a variety of filler and control items. First of all there were T- and F-items, filler items which were very clearly true or false in the context. These served to filter out participants who did not pay attention, or who failed to understand the task. The experiment also contained so-called Quantifier-Controls (Q-controls). These were simple quantified statements of the form *Every/each/all X v-ed a Y*. These items were included to check whether the participating children had basic knowledge of universal quantification. They were modelled after Drozd and Van Loosbroek's (2006) Irrelevant Property Condition. Drozd and Van Loosbroek (following Drozd, 2001) hypothesize that children may sometimes fail to recover the presupposed set when interpreting quantified statements (causing them to make the Exhaustive Pairing-error). In order to make sure that the presupposed sets were salient to the children, Q-controls preceding the test statements introduced both the domain of quantification of the universal quantifiers, and the source set for the indefinite. To give an example, when the test statement was *The bear has given a hedgehog every piece of cake*, there would be two Q-items: *every piece of cake has a candle*

²⁷ When children are presented with a variety of similar test sentences, this increases the risk of carry-over effects (even if they are interspersed with filler-items). We felt it was more important to have each child judge both ONE>ALL and ALL>ONE events, than to have them judge all of the different dative constructions. For this reason the dative-construction was a between-participants factor, and the event-type was a within-participants factor.

²⁸ Dutch has two distributive universal quantifiers, *elk* and *ieder*. While English *each* and *every* differ in the constructions in which they can occur, and the interpretations they license (see for instance Vendler, 1967; Ioup, 1975; Kadmon and Landman, 1990; Beghelli and Stowel, 1997; Tunstall, 1998), the two Dutch quantifiers are the same in all relevant aspects (see Van der Ziel, 2008).

on it, and *every hedgehog is wearing a blue jumper*. The former Q-item happened to be true, as each piece of cake indeed had a candle on it, the latter would be false as only two of the foxes wore a blue jumper.

Finally children were presented with dative controls, e.g. dative constructions of the same type as the constructions used in the test conditions (e.g. SPP-Dat, PP-Dat and DO-Dat), except that they did not contain universal quantification. This control condition was included because previous research (Waryas and Stremel 1974; Cook, 1976; Roeper et al, 1981) has suggested that although children seem to produce double-object constructions at an early age, their comprehension of these constructions may be delayed (see section 2.5.2 for more discussion of this issue). Each child was presented with dative controls of the same type as the dative construction she was tested on.

2.4.3 Materials

As stated in the previous section, children were presented with one story for the IS-conditions, and three stories for the dative-conditions. Each story contained both a ONE>ALL and an ALL>ONE event. The stories for the dative conditions were constructed in such a way that the ordering of ONE>ALL and ALL>ONE events could be reversed easily. The ordering of the events was counterbalanced across participants. For all participants the IS-story was the second story of the experiment, after a short warm-up story. This IS-story was followed by the three stories testing dative constructions. The ordering of the latter three stories was counterbalanced. Each of the stories came first once. This counterbalancing of dative stories and event-types meant that there were six distinct versions of the experiment.²⁹ A sample story for the dative conditions is presented in (12). The other stories that were presented to the children can be found in Appendix 1.

²⁹ To be precise, in version A: ONE>ALL preceded ALL>ONE for two of the stories ('Birthday' and 'Letters'), ALL>ONE preceded ONE>ALL for one of the stories ('Shop'). In version B the event-ordering would be the other way around. Within these two main versions there were also three distinct orderings of the stories: Birthday>shop> letters; Shop> letters> Birthday; Letters> Birthday> shop.

(12) **Sample story Datives: Birthday Party**

Background: This story is about a bear who is celebrating his birthday. He has invited all of his friends to celebrate with him. Three hedgehogs and a mouse attend the party.

ONE>ALL Event: The bear offers his friends some cake. The first hedgehog declines because he does not like cake. The second hedgehog states that he is not hungry. The mouse declines because he thinks the pieces of cake are too big. The third hedgehog is very hungry and claims to be able to eat all of the pieces of cake. The bear subsequently gives him all three pieces of cake.

Test statements:

De beer heeft een egel elk stuk taart gegeven. (DO-Dat)

‘The bear gave a hedgehog every piece of cake’.

De beer heeft elk stuk taart aan een egel gegeven. (PP-Dat)

‘The bear has given every piece of cake to a hedgehog’.

De beer heeft aan een egel elk stuk taart gegeven. (SPP-Dat)

‘(??) The bear gave to a hedgehog every piece of cake’.

ALL>ONE Event: The bear also has three party hats which he wants his friends to have. He first gives one to hedgehog 1, and then he gives one to hedgehog 2. He also puts one on the mouse’s head, but it is way too big for the mouse. Therefore, the mouse gets a balloon and the third hedgehog is given the party hat instead.

Test statements:

De beer heeft een egel elk hoedje gegeven. (DO-Dat)

‘The bear gave a hedgehog every hat’.

De beer heeft elk hoedje aan een egel gegeven. (PP-Dat)

‘The bear gave every hat to a hedgehog’.

De beer heeft aan een egel elk hoedje gegeven. (SPP-Dat)

‘(??) The bear gave to a hedgehog every hat’.

As can be observed in the sample story, the contexts used in this experiment differ from the contexts used in Su (2001b) in some important

respects (see section 2.2 for a sample story from Su's experiment). This experiment used the same event-types as Su (2001b), e.g. ONE>ALL and ALL>ONE events. However, unlike in Su's study, the events were presented in separate parts of the stories and after each part of the story the puppet already presented the test statements. In Su's experiment multiple events were intertwined in each story, which made the stories very complicated. Furthermore, in Su's experiment children had to wait until the end of the whole story in order to judge the test statements, meaning that they would have to keep many things (characters, objects and events) in memory for an extended period of time. By presenting the test statements during the story as well, we reduced the memory load of the experiment. The story in (12) also introduces fewer characters and objects than Su's experiment, further reducing the memory load. One final difference is that in this experiment we used a story-book with pictures to tell the stories, rather than having the stories acted out with props and toys. One advantage of this set-up is that the fact that the puppet does not see the actions of the story that is told (only the child saw the pictures in the story-book) makes it more felicitous for the puppet to make incorrect statements about the events that occurred in the story.

The stories were printed in a booklet with text on the left-hand side and a (coloured) picture (size A5) on the right-hand side.

2.4.4. Results

The experiment described in this section tested children's interpretation of transitive sentences with an indefinite subject and a universally quantified object, and multiple dative constructions all containing an indefinite and a universal quantifier in different configurations. Children were also presented with multiple control conditions. Performance on these latter conditions was highly accurate (e.g. 97%) and therefore all children were included in the analysis presented in this section.³⁰

2.4.4.1 The IS-Conditions

There were 36 children who judged both IS-conditions.³¹ Recall that children were only presented with one trial of each of these conditions. Of

³⁰ The exact percentages of targetlike responses per control condition are presented in Appendix 2.

³¹ Four children failed to judge one or both instances of the IS-condition.

those children 61.1% (N=22) incorrectly judged the IS sentence (see (10)) to be a true description of an ALL>ONE-event in which each cat was eating a sausage, while 44.4% (N=16) incorrectly judged the test statement to be a false description of a ONE>ALL-event in which a single cat was eating all of the sausages. When the individual performance of the children is considered, four distinct performance patterns can be observed. These patterns and the number of children who displayed them are presented in table 2:

	ALL>ONE	ONE>ALL	Name of Pattern	N
Response Pattern	true	false	Reverse	13 (30.5%)
	false	true	Targetlike	10 (27.8%)
	true	true	Ambiguity	10 (27.8%)
	false	false	Unclear	5 (13.9%) ³²

Table 2: Individual Response Patterns IS-condition

2.4.4.2 The Dative Conditions

This experiment included three distinct dative constructions. The predicted targetlike response patterns for these dative constructions are presented in table 3 below. The DO-Dat construction and the SPP-Dat construction are scopally unambiguous (see (11)). Children performing targetlike should judge DO-Dat and SPP-Dat sentences to be true for ONE>ALL events and false for ALL>ONE events. PP-Dat sentences, on the other hand, are scope ambiguous. The test sentence is a true description of both a ONE>ALL and an ALL>ONE-event. Each child was presented with 6 instances of one type of the dative sentences, three times as a statement describing a ONE>ALL event and three times as a statement describing an ALL>ONE event. For convenience, the target responses for each of the conditions are presented in table 3 below.

³² Those children who judged both test sentences to be false generally justified their NO-responses in ALL>ONE events by claiming that ‘not all cats are eating a sausage’. This is probably due to a flaw in the picture which shows one cat with a sausage from which he has taken a bite. The sausage, however, is not in his mouth. Their justifications for the ONE>ALL-event corresponded to the responses of the Reverse-children. Most likely these children should also be classified as Reverse-children. This would bring the percentage of Reverse-children to about 40%.

condition	Target responses (score)	
	ONE>ALL	ALL>ONE
DO-Dat	YES	NO
SPP-Dat	YES	NO
PP-Dat	YES	YES

Table 3: Target Responses

Table 4 presents the degree to which children accepted the test sentences. The percentages are also presented in graph 1, in which the results are plotted alongside the results reported in Su (2001b) for English, and the target performance (e.g. the expected performance pattern if the children had acquired Scope Freezing).

condition	ONE>ALL event		ALL>ONE event	
	total N of trials	% true (N)	total N of trials	% true (N)
DO-Dat	38	31.3 (12)	37	75.7 (28)
SPP-Dat	42	40.5 (17)	42	71.4 (30)
PP-Dat	39	46 (18)	39	97.4 (38)

Table 4: Mean Scores Child Participants

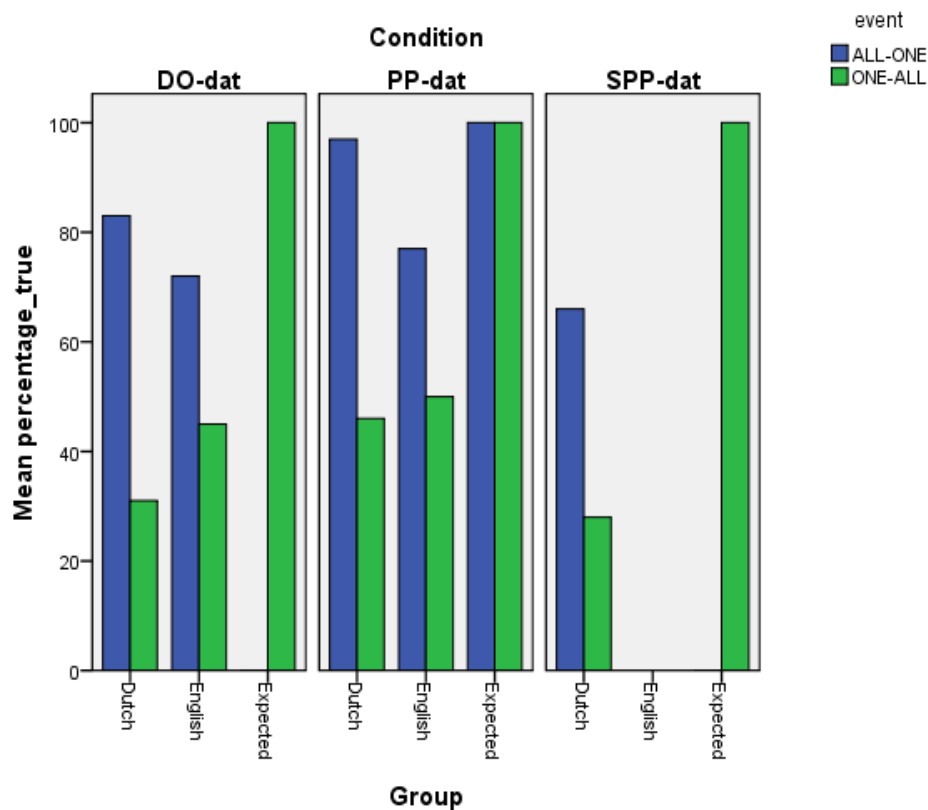

Graph 1: Mean Percentage Truth Judgments Dutch- and English-Speaking Children

The results show that, like the English-speaking children, Dutch-speaking children of a similar age are eager to accept the distributive interpretation of the datives, but tend to reject the ONE>ALL-interpretation of the same sentences. This result suggests that Dutch-speaking children also show the Reverse-pattern. Furthermore, the Dutch children do not differentiate between the three dative constructions. A Kruskal-Wallis test revealed no significant differences between the three conditions for either ONE>ALL events ($\chi^2(2) = 1.001$, $p \geq .606$) or ALL>ONE events ($\chi^2(2) = 4.999$, $p \geq .082$).

For the dative constructions, like for the IS-conditions, three clear individual response patterns can be distinguished.³³ For the DO-Dat

³³ Children were classified as displaying a certain response pattern when they showed maximally one deviation from the idealized pattern. The responses of some

condition and the SPP-Dat condition these are presented in table 5, for the PP-Dat condition in table 6.³⁴

condition:	ONE>ALL event	ALL>ONE event	name of pattern	N
Response Pattern	false	true	Reverse	14 (51.9%)
	true	false	Frozen Scope (FS)	5 (18.5%)
	true	true	Ambiguity	2 (7.4%)

Table 5: Response Patterns Child Participants (DO-Dat, SPP-Dat)

Condition:	ONE>ALL event	ALL>ONE event	name of pattern	N
Response Pattern	false	true	Reverse	5 (38.4%)
	true	false	Frozen Scope (FS)	0
	true	true	Ambiguity	7 (53.8%)

Table 6: Response Patterns Child Participants (PP-Dat)

The data in tables 5 and 6 show that many children, e.g. 56.6% for SPP-Dat and DO-Dat and 38.4% for PP-Dat, consistently display the Reverse-pattern.³⁵ Though the overall analysis revealed no significant differences between the dative-types, an analysis of the individual pattern shows that for the PP-Dat condition more than half of the participants perform targetlike (e.g. judge all test statements to be true).³⁶

All children were presented with both IS-sentences (e.g. transitive sentences with an indefinite subject and a universally quantified object), and one type of dative-construction. One reason to include both sentence types in

children (six in the case of DO-Dat/SPP-Dat (20%) and one in the case of PP-Dat (7.7%)) could not be classified according to any of the three response patterns.

³⁴ The results for DO-dat and SPP-dat were collapsed because the target responses for these two conditions are identical.

³⁵ 30 of the 43 children, e.g. 69.76% show the Reverse-pattern on at least one story (e.g. one ONE>ALL, ALL>ONE combination). .

³⁶ Note that this result is most likely not the result of something like the YES-bias which is often mentioned in child language studies. If it were, we would have predicted a similar high percentage of yes/yes responses in the other dative conditions. This, however, is not attested.

this study was to investigate whether the Reverse-pattern observed for English ditransitives and the Reverse-like patterns observed for transitive sentences in fact constitute the same non-targetlike pattern. If this is the case, then we expect children who show the Reverse-pattern on one construction to also show the Reverse-pattern on the other construction. The Reverse-pattern seems to occur less often with transitive sentences than with ditransitives, as the results reported in this section confirm. Given this, we would expect children who show the Reverse-pattern on the IS-sentences to also do so on the dative sentences. A total of 8 out of the 11 children who showed the Reverse-pattern on the IS-conditions also showed the Reverse-pattern in the dative conditions. In other words, most of the children who show the Reverse-pattern on the IS-conditions indeed also show the Reverse-pattern on the dative conditions. Of the remaining three children two showed the Reverse-pattern on at least one of the stories testing dative constructions, but judged the rest of the sentences to be true. The other child judged all dative sentences to be true. Children who performed targetlike on the IS-sentences did not always do so on datives. However, all children who performed targetlike on the dative sentences also performed this way on the transitive (IS) sentences.

2.4.4.3 Children's Justifications of their Judgments

As discussed in section 2.4.2, when children judged the test sentence to be false, the puppet would ask them to explain to him why he was wrong. For most children providing such justifications proved easy.

Children who showed the Reverse-pattern judged the test statements to be false of ONE>ALL events. When confronted with the sentence *the bear gave a hedgehog every piece of cake* as a description of a situation in which a single hedgehog is given every piece of cake by the bear, they deny that the test sentence is true. When asked to explain why the test sentence is false, they generally say something like (13) or (14):

- (13) *Nee, want één egel kreeg alle stukken taart.*
 'No, because one hedgehog got all pieces of cake'.
- (14) *Nee, want één kreeg ze allemaal*
 'No, because one got them all'.

Children's responses indicate that they encode the visual input and the discourse establishing the context as intended, as in the ONE>ALL event it is indeed the case that a single hedgehog gets all pieces of cake. However, apparently for these children the test sentence cannot be used to describe

such a situation. In other words, the responses show that children are interpreting the test sentence as having a certain reading whose truth conditions are not satisfied, a reading which adults cannot assign to this sentence, and that, for some reason, they consider this the only possible reading. Similar justifications were reported in Su (2001b) and Philip and Coopmans (1995).

Some children (N=4) performed targetlike. These children judged the test statements to be true of ONE>ALL events, but judged them to be false of ALL>ONE events. When presented with the sentence *the bear gave a hedgehog every hat* in a situation in which every single one of three hedgehogs gets a hat (exhausting the set of hats), they judge the test statement to be false. They subsequently justified their no-response by saying something like (15):

- (15) *Nee, want elke egel heeft één/een hoedje gekregen.*
 ‘No, because every hedgehog got one/a hat’.

Their response is exactly as predicted if they have acquired Scope Freezing. Children who have acquired the constraint should only allow the test statement to mean that a single hedgehog gets all hats. A distributive interpretation of the test sentence should be blocked.

2. 4.4.4 Further Analyses

In this experiment children were presented with multiple trials of the test and control conditions. A repeated-measures design always runs the risk of inducing carry-over effects.³⁷ That is, children’s judgments on and perception of earlier trials could influence their performance on later trials. To address these concerns children’s performance on the first trial of a condition was compared to their average performance on all trials. For ALL>ONE events no significant differences were found ($p > .05$). For ONE>ALL events significant differences were observed for the DO-Dat condition ($p \geq .024$). Children judge DO-DAT sentences to be false of ONE>ALL events more often on the first trial than on later trials. In the case of ONE>ALL events performance is thus less consistent than in the case of ALL>ONE events (at least with double-object datives). Though as stated above, these results are hard to interpret, the fact that there is a difference in relative consistency between the event-types suggests that the source of the

³⁷ Though carry-over effects can also occur in single measure designs in which the conditions are very similar.

“errors” for the two event types may be different. This issue will be discussed in more depth in section 2.6.

The experiment tested three ditransitive predicates. Friedman tests revealed that, while there was no significant effect of the predicate used in the test sentence for ALL>ONE events ($\chi^2(2) = .250$, $p \geq .882$), there was for ONE>ALL events ($\chi^2(2) = 7.11$, $p \geq .029$). In particular, children judged test statements containing *to sell* to be true of ONE>ALL events significantly more often than test statements containing *to give* or *to bring*.

Finally, the children were divided into three age groups, the 4-year olds ($n = 11$, mean age 4;8), the 5-year olds ($n = 21$, mean age 5;6), and the 6-year olds ($n = 11$, mean age 6;3). Kruskal-Wallis tests did not reveal any effects of age (all p -values $\geq .166$).

The general tendency is that children are very consistent in their judgments of test statements after ALL>ONE events. However, their performance on test statements presented after ONE>ALL events is less consistent and more easily influenced by other factors, like the predicate that is used, and their judgments on earlier trials.

2.4.4.5 Results Adult Controls

A group of 10 adults was also presented with the experiment. 70% of them performed target-like. That is, when presented with PP-Dat sentences they judged the test sentences to be true for both ONE>ALL and ALL>ONE events.³⁸ When presented with DO-Dat and SPP-Dat sentences they judged the test sentences to be false for ALL>ONE events and true for ONE>ALL events. However, three participants deviated from the expected targetlike pattern. Two participants displayed the Reverse-pattern. One participant showed mixed behaviour, e.g. he judged both ONE>ALL and ALL>ONE events to be false two thirds of the time.

For the IS-sentences, most adults (80%) performed targetlike, the other two adults showed the Reverse-pattern. In general, however, the results for this condition are similar to the results reported in Philip (2005).

2.5 Discussion

Section 2.3 described an experiment which further investigated the non-targetlike pattern observed in earlier studies on the acquisition of frozen scope in simple transitive sentences in Dutch and ditransitives in English. It robustly replicated the Reverse-pattern for three different dative

³⁸ Recall that PP-Dat sentences are ambiguous.

constructions in Dutch, as well as for simple transitive sentences.³⁹ That is, between 38 and 52 percent of the children showed the Reverse-pattern for the dative constructions, while 30 percent of the children did so for simple transitive sentences with an indefinite subject and a universally quantified object (e.g. the IS-conditions). Most children who showed the Reverse-pattern on the IS-sentences also performed this way on the dative constructions. However, the Reverse-pattern occurs more often with ditransitive than with transitive sentences.

The next question is how we should explain this Reverse-pattern. Three logical possibilities will be considered: (i) that children only allow a wide scope construal of the universal quantifier, (ii) that children have not fully acquired the structures of the constructions tested, or (iii) that the Reverse-pattern is in fact just another instance of Exhaustive Pairing. As we will see, none of these three explanations is able to fully capture the Reverse-pattern.

2.5.1 Inverse Scope of the Universal Quantifier

Children who show the Reverse-pattern judge test sentences to be true of ALL>ONE events. In other words, they allow a distributive interpretation of the test sentences. This suggests that the option of a wide scope interpretation of the universal quantifier is available to them. Could it be the case that for these children the wide scope reading of the universal quantifier is the only option? Ignoring for the moment the question of why children would entertain such a hypothesis, assuming that they only allow a wide scope reading does not in fact explain the Reverse-pattern. If children allowed a wide scope interpretation of the universal quantifier, they should judge test sentences to be true in both ALL>ONE situations and in ONE>ALL situations. Consider the following sentence:

- (16) Snow White gave a lady every balloon.

The verification procedure for the distributive universal quantifier requires one to check whether a certain property holds for each individual element in

³⁹ At a late stage in the writing of this dissertation, Philip's (1996) study was brought to my attention. Philip (1996) used a non-storybased truth-value judgment task to test Dutch preschool children's interpretation of double-object constructions with an indefinite indirect object and a universally quantified direct-object. Most participating children (>90 percent) rejected test sentences in ONE>ALL type situations, and accepted them in ALL>ONE type situations, thus providing additional evidence for the existence and strength of the Reverse-pattern.

the restriction set of the quantifier. In the case of (16) the property would be that of being given to a lady (by Snow White). Note that the interpretation procedure does not require there to be distinct ladies for each element in the reference set. When a single lady is given all the balloons, then for every balloon it is the case that it is given to a lady. When the test sentence is interpreted under wide scope of the universal quantifier, the sentence is thus also true in a situation in which a single lady gets all the balloons. More formally, there is an ENTAILMENT relation between the two scope interpretations.⁴⁰ Whenever the test sentence is true under the wide scope interpretation of the indefinite, it is also necessarily true under wide scope of the universal quantifier (\exists wide scope \rightarrow \forall wide scope).

To summarize, the hypothesis that children only allow wide scope of the universal quantifier and thus have a decidedly non-targetlike scope construal does not by itself explain the response pattern observed in the studies reviewed in this chapter. Since wide scope of the universal quantifier is entailed by wide scope of the existential quantifier, the Reverse-pattern is not predicted to occur. Rather, children who entertain this hypothesis should judge the test sentences to be true for both ALL>ONE and ONE>ALL events.⁴¹

2.5.2 Incomplete Syntax Acquisition

The Reverse-pattern is most clearly observed with dative constructions. One possibility is that the Reverse-pattern results from incomplete acquisition of the syntactic structure of the dative constructions in question. Though children already produce double-object datives when they are around two years old (see Snyder and Stromswold, 1994; among others), there is also evidence that children up to age 10 have problems interpreting double-object datives (Waryas and Stremel 1974; Cook, 1976; Roeper et al, 1981). Cook (1976), for instance, presented 90 English speaking children, who were between 5 and 10 years old, with an act-out

⁴⁰ A proposition X entails a proposition Y if whenever X is true, Y is also necessarily true.

⁴¹ One possibility is that children do allow (and perhaps only allow) wide scope of the universal quantifier, but also obey some additional constraint. Let us call this an Exclusivity constraint, which places demands on the objects of the event described by the sentence. In particular it requires the distributive events to be symmetrical and to thus apply to different (indirect) objects. This would lead children to judge the test sentences to be true of ALL>ONE events in which the different direct objects are given to different recipients, but reject the test sentence when there is a single recipient (e.g. in ONE>ALL events). We will come back to this possibility in later chapters.

task in which they were asked to act out sentences like: *The lion showed the giraffe the bear*. Even at age 10 almost 37 percent of the children had the lion show the giraffe to the bear. In other words, the children seemed to interpret the double-object dative as if it were a *to*-dative.

Though it is a logical possibility that children either have not acquired the complete syntactic structure of the double-object dative, or misanalyze the structure of the construction under certain conditions, this by itself cannot explain the Reverse-pattern. The Reverse-pattern is not only observed with double-object datives, but also with *to*-datives and mono-transitive constructions. While the Reverse-pattern occurs less often with transitive sentences than it does with double-object datives, it occurs equally often with *to*-datives.

There is also experimental evidence which shows that children have no problems with the structure of double-object datives. The experiment discussed in section 2.4 contained control conditions investigating children's interpretations of the different dative constructions (double-object datives, *to*-datives and scrambled *to*-datives). The children were presented with six instances of one of the dative constructions. Half of the time the sentence would be true, half the time it would be false. The only difference between the control sentences and the test sentences was that the control sentences did not contain a universal quantifier. In other words, they were sentences of the type: *The bear showed a boy the toy car*. The Dutch-speaking children were 94.8 percent accurate on this control condition (see Appendix 2 for the exact results).

In this section, it was shown that the Reverse-pattern is not caused by incomplete acquisition of the structure of dative constructions. Children are well able to interpret double-object datives in control sentences without indefinite articles and universal quantifiers. However, even if children could not do this, a misinterpretation of the structure of the double-object dative would still not explain their non-targetlike patterns (whether it be the Reverse-pattern or the Ambiguity-pattern), as non-targetlike performance is not limited to double-object constructions.

2.5.3 The Reverse-pattern and Exhaustive Pairing

The third possibility is that the Reverse-pattern, or at least children's rejection of the test sentence in ONE>ALL events, is in fact an instance of Exhaustive Pairing. This "error" is observed when children are presented with sentences like *Every boy is riding a pony* in a situation in which every single boy is indeed riding a pony but there is also an extra pony which is not being ridden. When asked whether this sentence is true or false, many

children judge the sentence to be false. When asked why this is the case, children generally refer to the riderless pony (see Inhelder and Piaget, 1964; Philip, 1995; Crain et al, 1996; among many others).

The ONE>ALL event is an event in which a single individual ends up with all the objects. However, in this event there are also two extra characters of the type denoted by the indirect object who are not involved in the action (see section 2.4.3 for a sample story). This, combined with the fact that non-targetlike performance on the ditransitives and mono-transitives tested in the experiments described in this chapter is predicted by some accounts of Exhaustive Pairing (in particular Philip (1995)'s Event Quantificational Account) has led researchers to consider both non-targetlike performance patterns on a par (Philip and Coopmans, 1995; Drozd and Van Loosbroek, 2006). However, I will argue that they are in fact not the same.

If children's rejection of test statements in ONE>ALL events is really an instance of Exhaustive Pairing, then we would expect children to also justify their NO-responses in a similar way. In the case of Exhaustive Pairing, children generally refer to the individuals who did not partake in the action.⁴² In the case of ONE>ALL events, such a justification is exceedingly rare. Of the 68 interpretable justifications that the children provided, only four referred to the extra individuals, as in (17).⁴³

- (17) *Nee, want deze hebben niets gekregen*
No, because these ones got nothing.

Generally, children state that *ONE X got ALL the Ys*. This argument is not foolproof, however. The experimental contexts in which the test sentences are presented are not identical. In traditional exhaustive pairing spreading examples, the extra individual is salient, and for this reason children may refer to this individual in their justifications. In ONE>ALL events, on the other hand, the one individual who does partake in the action stands out.

A second argument against considering children's NO-responses on ONE>ALL events as an instance of Exhaustive Pairing comes from studies which tested children on both the classical exhaustive pairing examples, and ONE>ALL and ALL>ONE events. One such study is Philip and Coopmans (1995).⁴⁴ In this study it was observed that (i) children reject the test sentences of ONE>ALL events significantly more often than they show Exhaustive Pairing (75 percent incorrect rejections for ONE>ALL events, 37 percent quantifier spreading in asymmetric distributive situations), and (ii)

⁴² Some children, however, say something like "only three" or "not enough".

⁴³ These responses belonged to only a couple of children who gave this response on multiple trials.

⁴⁴ See Philip (1996) for more evidence of the same type.

that this persists at an age at which Exhaustive Pairing has more or less disappeared (e.g. age 8).⁴⁵

In this section I have presented two arguments against subsuming (part of) the Reverse-pattern under Exhaustive Pairing. In chapter 4 we will observe another argument against a direct link between the Reverse-pattern and Exhaustive Pairing, namely that whereas Exhaustive Pairing has been observed with all universal quantifiers, the Reverse-pattern seems to be limited to sentences containing DISTRIBUTIVE universal quantifiers.

2.6 Conclusion

In this chapter it was shown that many children show a distinct non-targetlike performance pattern when they are presented with sentences containing an indefinite and a universal quantifier. This performance pattern was called the Reverse-pattern. Children showing this pattern not only accept test sentences in symmetrically distributive ALL>ONE events, but they also reject the same sentences in ONE>ALL events in which one individual ends up with all the objects. The goal of this study is to determine what could cause this Reverse-pattern. In the previous section we have already reviewed, and excluded, some possible explanations of the Reverse-pattern. In the next chapters we will investigate other possible explanations, namely that the Reverse-pattern results from a non-targetlike interpretation of the indefinite article, or is the result of some problem interpreting universal quantification.

However, before turning to other explanations, we need be clear about exactly what we are trying to explain. Are we looking for an explanation which both explains children's NO-responses in ONE>ALL situations and

⁴⁵ In this experiment the test sentences for the traditional exhaustive pairing contexts had a universally quantified subject and an indefinite object. The test sentences that were used in ONE>ALL events had an indefinite subject and a universally quantified object. Philip and Coopmans relate the asymmetry in performance between these two conditions to reluctance on the part of the children to apply the operation of quantifier raising (QR). They assume that in order to obtain an object quantificational interpretation of the test sentences with a universally quantified object, QR must apply. However, this is arguably a costly operation (Fox, 1995). Because of this children instead opt for a simpler type of quantification which does not require QR to build up an appropriate Logical Form, namely event quantification. The assumption is that an event quantificational interpretation of the test sentence leads children to make the Exhaustive Pairing "error". In effect they thus assume that event quantification is more prevalent when the universal quantifier occurs in the object than in the subject.

children's YES-responses in symmetric distributive situations (e.g. ALL>ONE events) or are we looking for an explanation for the most puzzling aspect of the Reverse-pattern, namely children's NO-responses in ONE>ALL situations. Research on frozen scope in transitive sentences in Dutch suggests that after children display the Reverse-pattern, there is a stage in which children judge both interpretations to be true (Philip, 2005, and section 4.4.1). Recall that in the experiments discussed in this chapter we also observed another non-targetlike pattern which I called the Ambiguity pattern. Though it is hard to determine whether the YES-YES responses of the Ambiguity pattern reflect children's linguistic competence, or a response strategy, it is certainly possible that the Ambiguity pattern actually represents an intermediate stage in the acquisition of targetlike scope construals, and thus reflects the linguistic competence of the children who show this pattern. Children may thus not behave completely targetlike when they, at some point, move away from the Reverse-pattern. It thus seems likely that what needs to be explained first is what causes the NO-responses, and how children eventually overcome this. This conclusion is further strengthened by the fact that children's performance on ALL>ONE events is relatively stable, while their performance on ONE>ALL-events seems to be affected by carry-over effects and certain item effects. If both instances of non-targetlike performance had the same underlying cause, then responses on both ALL>ONE events and ONE>ALL events would be expected to be equally stable or unstable. In the next chapters different ways of explaining the data are proposed and evaluated. Some of these accounts attempt to provide a unified explanation of the Reverse-pattern, while others specifically try to explain children's responses on ONE>ALL events.

Chapter 3

Lexical Factors I: The Indefinite

3.1 Introduction

In chapter 2 it was shown that between 40 percent and 52 percent of Dutch- and English-speaking preschool children show a non-targetlike performance pattern when presented with sentences like (1).

- (1) The bear gave a fox every piece of cake.

That is, these children rejected sentence (1) as a description of a situation in which a single fox is given every piece of cake (a ONE>ALL event), but accepted it in a situation in which every piece of cake is given to a different fox (an ALL>ONE event). This performance pattern was named the Reverse-pattern, as it is the reverse of the targetlike performance pattern for double-object datives like (1).

In section 2.5.1 it was shown that this non-targetlike pattern cannot be explained by assuming that children, unlike adults, must assign wide scope to the universal quantifier, as wide scope of the universal quantifier is entailed by wide scope of the existential quantifier. Because of this entailment relation, for sentences like (1) wide scope of the universal quantifier is true in all cases in which wide scope of the indefinite is true. Hence, no matter which scope construal children opt for, they should always accept the test statements in ONE>ALL situations. Furthermore, incomplete acquisition of the syntactic structure of the double-object construction also fails to explain the Reverse-pattern, as children were shown to have no problems interpreting double-object constructions without indefinites and universal quantifiers and seemed to be aware of the hierarchical relation between the direct object and the indirect object. Finally, the non-targetlike pattern was argued to be distinct from the well-known Exhaustive Pairing phenomenon.

This chapter is the first of two chapters investigating the role of lexical factors. In it we will review three possible accounts which relate the Reverse-pattern to a non-targetlike interpretation of the indefinite article.

The first one is Su (2001b)'s Lexical Factor Account, which was formulated specifically to capture the Reverse-pattern. This account relates the Reverse-pattern to incomplete acquisition of the full meaning of the indefinite article *a/an*. The second is Krämer (2000)'s Non-Integration Account, which was formulated to explain Dutch-speaking children's non-targetlike interpretation of sentences in which scrambled indefinite objects interact with other scope taking elements, like negation or adverbs of quantification. The main idea is that children acquire the specific interpretation of indefinites later than the 'predicative' narrow scope interpretation of the indefinite, as the former requires discourse integration. However, a detailed investigation of this account will show that the Non-Integration Account cannot be extended to capture the Reverse-pattern, because of the same entailment problem which was discussed above (and in section 2.5.1). The third account will be named the Singleton Restriction account. This account is based on Schwarzschild (2002)'s hypothesis that specific indefinites are existential quantifiers whose domain is restricted to a singleton set. The idea behind the Singleton Restriction account is that children may have problems interpreting indefinites as singleton indefinites (and thus have problems restricting the domain to a singleton set) in certain contexts.

Predictions derived from Su's account (or rather from extensions of the original account) and from the Singleton Restriction account will be tested in three experiments. The first two will specifically test predictions of Su's Lexical Factor Hypothesis, namely that the Reverse-pattern should not be observed when English-speaking (or Dutch-speaking) children are presented with sentences similar to (1) in which the indefinite article is replaced by either the singular indefinite determiner *some*, or the numeral *one*. The third experiment investigates whether children will perform targetlike when the indefinite interacts with a scope-taking element like *twice*.

3.2 The Lexical Factor Hypothesis

Su and Crain (2000) and Su (2001a,b) investigated English- and Chinese-speaking children's interpretation of sentences like (1). It was observed that while English-speaking children showed the Reverse-pattern almost half the time, Chinese-speaking children never did (see section 2.2). One difference between the two languages is that in Chinese the lexical item which is generally identified as an indefinite (and which was used in Su's studies), *yi-ge*, is also the numeral 'one', while in English the indefinite and the numeral are not homophonous, but rather are two separate lexical items (e.g. *a/an* and *one*). Capitalizing on this difference, Su (2001b) proposed the

Lexical Factor Hypothesis (LFH). The original formulation of the LFH is presented in (2).

(2) The Lexical Factor Hypothesis: “Children’s non-adult interpretation [...] results from a lexical idiosyncrasy between English ‘a’ and Chinese ‘yi-ge’. At an early stage of development, English-speaking children analyze the indefinite ‘a’ as meaning ‘any’ (i.e. non-specific), whereas Chinese-speaking children consider ‘yi-ge’ to mean “exactly one” (i.e. specific)” (110).

In this chapter we will show that while some lexical idiosyncrasy could plausibly explain Chinese children’s performance, the LFH fails to capture the occurrence of the Reverse-pattern in English and Dutch child language. In the next sections the motivations behind the LFH will be investigated further, and multiple testable predictions will be derived from it. This is followed by a discussion of two experiments testing the predictions of the LFH.

3.2.1 Reanalyzing the Lexical Factor Hypothesis

The original formulation of the LFH as given in (2) raises the following questions:

- (i) Why would English-speaking children misanalyze ‘a/an’?
- (ii) What does it mean to analyze ‘a/an’ as ‘any’?

These questions will be considered in turn in the next two sections.

3.2.2. Why would children misanalyze ‘a/an’?

Su (2001b) hypothesized that children’s non-targetlike interpretation of the indefinite may be caused by the fact that English has another lexical item which refers to single individuals, e.g. the numeral *one*. As stated in Su (2008: 7): “As for the English indefinite ‘a/an’, although most of the time it also means “one”, but since English has another word for the numeral ‘one’, English-speaking children in the earliest stage of development distinguish ‘one’ from ‘a/an’ and consider the former to mean “exactly one”, but the latter to mean something similar to “any”.”

The above statement leaves open several alternatives. I will take it to mean that the idea behind the LFH is that children assign non-overlapping meanings to the lexical items *a/an* and *one*, in accordance with, for instance,

MUTUAL EXCLUSIVITY (Markman, 1989) or the UNIQUE ENTRY PRINCIPLE (Pinker, 1984). If *one* means ‘exactly one’, then it can only refer to singleton sets, e.g. sets whose cardinality is one ($|1|$). Following Mutual Exclusivity the indefinite should have a non-overlapping meaning and should not be used to refer to such sets. This means that children should take it to mean ‘not exactly one’ ($|X| \neq 1$). Based on this line of reasoning, I offer the following reformulation of the LFH:

- (3) Modified Lexical Factor Hypothesis: The difference between the performance of the English and Chinese-speaking children is caused by a lexical idiosyncrasy between the two languages. At an early stage of development Chinese-speaking children treat *yi-ge* as meaning something like ‘exactly one’. At an early stage of development English-speaking children do not allow *a/an* to have a meaning that overlaps with the meaning of the numeral *one*. That is, they do not allow the DP headed by *a/an* to refer to a set whose cardinality is ‘exactly one’.

Let us examine how this modified LFH explains the difference between the Chinese-speaking and the English-speaking children. In the case of a ONE>ALL event, a single individual ends up with all the objects. In order to accept the test statement children need to be able to have the phrase *a/an N* refer to that singleton individual. Chinese-speaking children should allow this interpretation (as they can and in fact must interpret *yi-ge* as referring to a set whose cardinality is ‘one’ (see (3)), which explains why they generally accept the test statements for this type of event. If children do not allow this interpretation of the indefinite article, then they should judge the test sentence to be false, which is what the English-speaking children do. In ALL>ONE events, on the other hand, the objects are distributed over multiple individuals. The reference of the indefinite is thus not restricted to a single individual. Therefore, English-speaking children can and do judge the test sentences to be true in this situation-type. Note, however, that this interpretation (i.e. the distributive interpretation in which, for instance, every element in a set of cakes is distributed over multiple characters), can in principle only come about if the universal quantifier takes wide scope, and this would imply that English-speaking children either have not acquired or temporally override the Frozen Scope Constraint.⁴⁶ There are two ways to

⁴⁶Su (2001b) suggests that English children may not have acquired the quantifier status of the indefinite yet. Since on this assumption for them the indefinite is not a quantifier, there is no scope interaction between the indefinite and the universal

explain the Chinese-speaking children's targetlike performance. One possibility is that by the age of four Chinese children have already acquired the Frozen Scope Constraint. Alternatively, if following the LFH in (2) and (3) Chinese-speaking children indeed interpret 'yi-ge' as 'exactly one', they could also reject the test statement just because in the ALL>ONE event there is not exactly one fox who gets all the cakes. That is, this kind of interpretation does not necessarily have to come about through obedience of scope freezing.

Recall that most of the English-speaking children who rejected the test statements as a description of ONE>ALL events justified their no-responses by stating something like: *One X got ALL Y*. The modified LFH can capture these justifications. In a ONE>ALL event one individual ends up with all the objects. The children may not allow *a/an N* to have a singleton reference, but they do allow *one X* to have this reference. In their justifications they therefore replace *a/an* with *one*.

Both the original and the modified LFH relate the Reverse-pattern to incomplete lexical acquisition. At some point children should learn that the indefinite article could be used to refer to (singleton) individuals. In principle children should be able to acquire this knowledge by just hearing the indefinite used in a situation in which it refers to a singleton set. However, if this is indeed the sole learning task, then a sentence like *Look, there is a squirrel in the tree*, uttered in a situation in which there is one squirrel in the tree could already provide evidence for the targetlike interpretation of indefinites. We would expect 4-6 year old children to have come in contact with such utterances a large number of times, especially since they themselves also use indefinites in situations in which the DP headed by the indefinite refers to a single individual.⁴⁷ In other words, from a learnability perspective it should be a simple task to acquire the correct meaning of the indefinite article, even if children initially assigned a non-targetlike meaning to the indefinite article. Therefore, the question is why five-year old children would not have acquired the target-like meaning of *a/an* in the face of so much positive evidence. We will put this question aside for the moment, and first focus on the predictions that the Modified Lexical Factor Hypothesis makes concerning the situations in which children are expected to show the Reverse Pattern.

quantifier. This evades the question whether children have knowledge of scope freezing.

⁴⁷ Examples from CHILDES (Van Kampen corpus)

Sarah 5;2.13: *en eh, daar heb ik een ring van gekregen*
and eh, there have I a ring from gotten

Sarah 5;2.13: *en we nemen een hele grote bladzijde.*
and we take a very large page.

The (Modified) Lexical Factor Hypothesis makes several testable predictions. First of all, since children's incorrect hypothesis only concerns the indefinite article *a/an*, children could in principle allow a specific/singleton interpretation of other indefinites, for instance the singular indefinite determiner *some*, and thus not show the Reverse-pattern. Second, since children are hypothesized to treat the numeral 'one' as meaning 'exactly one', we predict children to perform significantly more targetlike when presented with double-object constructions in which the numeral *one* occurs. That is, they should reject the test sentence as a description of an ALL>ONE event, and accept it as a description of a ONE>ALL event. In effect, when the numeral *one* is used, English-speaking children should perform like the Chinese-speaking children in Su (2001a, b).

3.2.3 What does it mean to analyze 'a/an' as 'any'?

In section 3.2.1 we asked two questions concerning the Lexical Factor Hypothesis as formulated by Su (2001b). The first question was why children would have problems interpreting the indefinite article *a/an*. The possibility that children assign non-overlapping meanings to *a/an* and *one*, and hence have a non-targetlike interpretation of the indefinite article, was examined. A reformulation of the LFH along these lines was proposed. However, the original LFH also made the claim that children interpret *a/an* as 'any'. If children interpret the indefinite as obligatorily non-specific (and thus not able to refer to a singleton entity), then this claim alone does not necessarily imply that for children the indefinite has a meaning similar to English 'any'. Though the Modified Lexical Factor Hypothesis is in principle able to explain the Reverse-pattern on its own, we will examine the second claim of the original LFH as well, in order to try and shed some light on the question of exactly which non-targetlike meaning children do assign to *a/an*.

It is unlikely that children interpret the indefinite article in exactly the same way as adult speakers would interpret 'any'.⁴⁸ For adults *any* is generally infelicitous in the declarative sentences used in my experiment, as sentence (4a) shows. The negative polarity item 'any' is only felicitous in so-called non-veridical contexts.⁴⁹ One such context is a question like (4b).

⁴⁸ If we follow the argumentation in section 3.2.2, this should in fact be impossible. If children do not allow *a/an* and *one* to have the same meaning, then they should not allow *a/an* and *any* to have the same meaning either.

⁴⁹ Since Ladusaw (1979) it is generally held that negative polarity items are only licensed in so-called Downward Entailing environments (e.g. an environment which

This, of course, presupposes that the distribution of ‘any’ and its meaning are intimately related. Children, however, may not be sensitive to these restrictions on the occurrence of *any*. Let us, for the sake of argument, assume that children attempt to answer the question in (4b). In the ONE>ALL event a single fox ends up with all of the cakes, so the answer to the question should be YES. Children should thus not show the Reverse-pattern.

- (4) a. ?? The bear gave any fox every cake.
 b. Did the bear give any fox every cake?

As shown above, just interpreting the indefinite as if it were Negative Polarity *any* does have drawbacks. However, perhaps NPI *any* was not what Su meant when positing that children may interpret the indefinite article as if it were ‘any’. In the concluding chapter of her dissertation, Su (2001b:155) states the following: “An important fact about the difference between the children’s interpretations of the indefinites *a/an* and *yi-ge* is that English-speaking children always consider all the entities introduced by the indefinite NP as a whole, but Chinese-speaking children only consider one of them. [...] To interpret the indefinite this way is like treating it as a bare plural (in the sense of Carlson, 1977) or a free choice *any* (Carlson 1981; Kadmon and Landman 1993) ...”. In this section we will examine this claim in more detail. We will investigate what kind of interpretation an indefinite would get if it were interpreted as if it were a bare plural or a free choice item, and whether this interpretation captures the intuition that English-speaking children seem unable to limit the reference of the indefinite to a single referent and thus consider all possible referents of the indefinites.

There is indeed some parallelism between the indefinite article, bare plurals and free-choice *any*, namely the fact that they can all have a (kind of) GENERIC interpretation, though the use of the singular indefinite article in characterizing sentences, or as a kind-referring DP, is relatively limited (see Cohen, 2001 among others). Consider the following examples taken from Kadmon and Landman (1993).

reverses the entailment relations which generally hold between the arguments), but this has turned out to be too narrow a definition. Currently the consensus is that negative polarity items like *any* are only felicitous in non-veridical environments (“A proposition operator *F* is veridical iff Fp entails p : $Fp \rightarrow p$; otherwise *F* is nonveridical” (Giannakidou, 2002)). Examples of non-veridical environments are include: the scope of negation, the scope of *only* and the scope of emotive factive verbs, among others.

- (5) a. Any owl hunts mice.
 b. Owls hunt mice.
 c. An owl hunts mice.

All the sentences in (5) can be paraphrased as ‘all owls hunt mice’, or ‘generally owls hunt mice’. In all cases the sentences thus have some UNIVERSAL QUANTIFICATIONAL FORCE.

In this section we will propose and discuss a variety of different hypotheses children could entertain, all of which bear some relation to the claim that children interpret *a/an* in a way which resembles ‘any’.

- (6) **Hypothesis 1:**
 Children do not interpret the indefinite article *a/an* as specific or referential, but rather as generic.⁵⁰

The indefinite article *a/an* can be interpreted in multiple different ways. It can have a referential interpretation, a partitive interpretation or a generic interpretation, among others. To judge the test sentence to be true in a ONE>ALL event, children need to interpret the indefinite partitively. However, what if children misinterpret the indefinite, and assign the sentence a generic interpretation instead? A generic interpretation of (5c) entails that it is generally true that an owl hunts mice.

There are major problems with such an account. First of all, generics apply to kinds in general, and not just to the exemplars of a certain kind in a specific context. The generic interpretations of the sentences in (5) do not make statements about just the set of owls in a discourse context, but owls in general. A generic interpretation thus requires real-world knowledge. Furthermore, generic sentences are not falsified if some exemplars of a certain kind do not possess the property described in the sentence, as long as it is generally the case that they have this property. Thus, sentence (5c) is still true if it turns out that some owls do not hunt mice.

Now consider sentence (7):

- (7) The bear gives a fox every piece of cake.

Under a generic interpretation, sentence (7) would mean something like (8):

⁵⁰ The possibility that children are not able to derive certain interpretations of indefinites is further examined in the discussion of Krämer’s (2000) Non-Integration Account in section 3.3 below.

- (8) Generally [(a) fox is given every piece of cake by a/the bear]

In order to truly evaluate the sentence one would have to consider not just the foxes in the context, but also foxes in general, and then decide whether it is generally the case that foxes are given every piece of cake by the bear. A generic interpretation is false in the case of a ONE>ALL event, as it is not generally the case that foxes are given every piece of cake by the bear. It is true for one of the foxes, but it is not generally so. Furthermore, this argumentation also predicts a NO-response on ALL>ONE events, e.g. events in which there are three foxes being given a single piece of cake. In this situation it is not the case that generally foxes are given every piece of cake by the bear. One may argue that perhaps children's generic interpretations differ from adult generic interpretations, and that perhaps children only evaluate the test sentence against the experimental context. However, the predicted NO-responses on ALL>ONE and ONE>ALL events still stand. In neither of the experimental contexts is it generally the case that a fox is given every cake by the bear. Only one of the foxes gets every cake. Interpreting the indefinite generically or semi-generically does not capture the Reverse-pattern.

Perhaps children do not assign a generic interpretation to the indefinite, but, as Su hypothesized, they interpret the indefinite as if it were 'free choice *any*'. This possibility is considered in hypothesis 2 below.

- (9) **Hypothesis 2:**
Children interpret *a/an* as if it were Free Choice *any*.

Certain natural language items can have a freedom of choice meaning (Vendler, 1967), for instance English 'any'. Consider the sentence in (10):

- (10) You can sing any song.

The above sentence implies (i) that the addressee is allowed to sing a song, and (ii) that this permission holds for whichever song the addressee chooses to sing. The choice is thus free for the addressee. What if children interpret the indefinite in sentence (7) as if it were a free choice item? If this were the case, then children would interpret sentence (7) to mean something like: For any fox, no matter which exemplar you consider, the property of being given every cake by the bear should hold.

As with generics, children who interpret *a/an* as if it were the adult FC-item should 'go beyond' the experimental context when evaluating the test sentences, and consider more exemplars than the ones available in the discourse context. However, this property of FC-items (as shown above for

generics) makes it impossible to predict exactly what scenario children will conjure up and which elements they will consider. In order to make predictions, we will assume that children only evaluate the exemplars in the experimental context and thus only allow the free choice meaning to apply in a limited domain.

If children only consider the foxes in the experimental context, then they should reject sentence (7) as a description of a ONE>ALL event. In such an event only one of the foxes ends up with every cake, and it is thus not the case that whichever fox one considers, that fox gets every cake. In ALL> ONE events every fox does get a cake. It is thus true that whichever fox one considers, that fox gets a cake, but it is not the case that whichever fox one considers that fox gets *every* cake. A free-choice- like interpretation of the indefinite article would thus predict NO-NO responses. Of course, Su (2001b) most likely did not mean such a literal interpretation of the ‘free-choiceness’ of *a/an*.

Su also states that children might interpret *a/an* as if it were a bare plural, a possibility which is explored in Hypothesis 3 below.

(11) **Hypothesis 3:**

Children interpret *a/an N* as the bare plural *Ns*.

Bare plurals are plural noun phrases without a (visible) determiner. One hypothesis is that bare plurals are like the indefinite article *a/an*, the only difference being the plurality of bare plurals. Unlike the indefinite article, bare plurals always take narrow scope with respect to other quantified expressions (Carlson, 1977), as is shown in sentences (12a, b):

- (12) a. Everyone read a book on linguistics.
(everyone>> a book; a book>> everyone)
- b. Everyone read books on linguistics.
(everyone>> books)

The English sentence (12a) is generally assumed to be ambiguous. *A book on linguistics* can take wide scope over the universally quantified DP leading to the interpretation where a specific book on linguistics is read by everyone. It can also be interpreted with narrow scope, in which case the sentence would be interpreted as: for every individual it is the case that this individual read a (possibly different) book on linguistics. Sentence (12b) does not display the same ambiguity. Inverse scope, and thus the interpretation that there is a certain set of books on linguistics that everyone read, is blocked.

If children were to interpret the indefinite DP in sentences like (7) as a bare plural, this would require children to ignore the indefinite article and lack of the plural morphology (though neither is phonologically salient). However, if children were to interpret (7) as (13)), then this would capture children's NO-responses on ONE>ALL events.

- (13) The bear gave foxes every piece of cake.
(every piece of cake>> foxes)

In a ONE>ALL event a single fox is given every cake, it is therefore not true that for every cake it is the case that it was given to foxes. Therefore children are predicted to reject the test statement in this type of event. In ALL>ONE events every piece of cake is given to a different fox. However, for the test sentence to be true, every piece of cake needs to be given to a plural set of foxes. This account thus incorrectly predicts that children judge test sentences to be false of ALL>ONE events, which children do not do (90percent acceptance, see chapter 2).

In this section the second part of Su's Lexical Factor Hypothesis, e.g. the hypothesis that English-speaking children assign a meaning to the indefinite article *a/an* which resembles the meaning of 'any', was investigated. Different ways of interpreting this statement were evaluated, all of which seem to have drawbacks. In particular, nearly all actually fail to predict the Reverse-pattern. In other words, the indefinite article must not be exactly like these linguistic items, but only have certain properties which those linguistic items also have, most notably the 'universal quantificational force'. When a sentence like *an owl eats mice* is interpreted generically, the property of eating mice needs to hold for owls in general. The generic operator thus adds some kind of quasi-universal quantificational force. When interpreting *any* in a sentence like *any owl eats mice* as a free-choice item, the requirement is that whichever owl one evaluates, it needs to have the property of feeding on mice. This implies that every element that one could possibly pick to evaluate the statement needs to have this property. Finally, bare plurals denote plurality. When evaluating a statement like *owls eat mice*, establishing that a single individual owl eats mice is irrelevant, there need to be at least two. Though this is less of a 'universal quantificational force', it does require the evaluation of more than a single element. In fact Su's statement concerning children's interpretation of *a/an* as 'any' seems to be motivated by the possibility that when interpreting a DP headed by an indefinite article in a situation in which the DP could refer to multiple individuals, children look at all these individuals, and not just at a specific one. That is, when children evaluate a statement like *The bear gave a fox*

every cake in a situation in which there are multiple foxes, children seem unable to limit themselves to a single fox, but rather seem to pay attention to all of the foxes in the context.

At this point we could attempt to incorporate this property of ‘universal quantificational force’ into the Modified LFH. However, the Modified LFH as it stands makes interesting predictions concerning the distribution of the Reverse-pattern. We will therefore not adapt the LFH, but in section 3.4 we will introduce a new hypothesis (the Singleton Restriction Hypothesis) which incorporates the property of ‘universal quantificational force’ in some way. Recall that the Modified Lexical Factor Hypothesis stated that children assign non-overlapping meanings to the indefinite article *a/an* and the numeral *one*, and thus have a non-targetlike interpretation of these lexical items. The meaning they assign to *a/an* causes the performance pattern which we named the Reverse-pattern. This account predicts that non-targetlike performance is limited to sentences containing that specific lexical item. However, a logical possibility is that children differ from adults in their interpretation of indefinites in general, not just with regard to a single exemplar. In the next two sections two accounts which explore this possibility are investigated. We start with Krämer (2000)’s Non-Integration Hypothesis.

3.3 *The Non-Integration Hypothesis*

Krämer (2000) investigated Dutch children’s interpretation of sentences in which scrambled direct object indefinites interact with some other scope-taking expression, particularly negation. It was observed that children often interpreted the object indefinite as being in the scope of the negative operator, and failed to derive a wide scope interpretation of the indefinite. Krämer argued that this was caused by incomplete acquisition of processes of discourse integration. In this section we will examine Krämer’s account in more detail, and investigate whether this account can capture children’s non-targetlike interpretation of sentences in which an indefinite interacts with universal quantification.

In Dutch, the relative position of an indefinite with regard to some other scope taking expression at least in part determines its interpretation. This can most clearly be seen in sentences with object indefinites. In sentence (14a) the object indefinite occurs in a “high” position relative to the negative operator *niet* (‘not’) (e.g the DP headed by the object indefinite c-commands the negative operator). For most adult speakers of Dutch this sentence can only mean that there is a certain fish that the boy did not catch. In other words, the indefinite gets a specific interpretation. When the

indefinite occurs in a low position relative to the negative operator *geen* ('not a') (see (14b), the sentence can only be truthfully uttered to describe a situation in which the boy did not catch any fish.

- (14) a. *De jongen heeft een vis niet gevangen.*
 the boy has a fish not caught
 'The boy didn't catch a fish'
- b. *De jongen heeft geen vis gevangen.*
 the boy has not-a fish caught
 'The boy didn't catch a fish'

This asymmetry between high and low indefinites is not just observed in sentences with a negative operator, but also, for instance, with adverbs of quantification like *twee keer* ('twice'), *altijd* ('always'), and *vaak* ('often'). In Dutch the relative positions can be derived through scrambling, e.g. a(n) optional) movement operation, which in Dutch can only reorder the relative position of adjuncts and certain arguments (see Ruys, 2001; De Hoop, 2003 among many others). It is generally assumed that in the case of (14a) the DP *een vis* ('a fish') has scrambled from its VP-internal position to a VP-external position in which it c-commands the negative operator.

Krämer assumes Van Geenhoven (1998)'s theory of indefinites, which distinguishes two distinct modes of interpretation. Indefinites can be interpreted predicatively, in which case the DP headed by the indefinite is interpreted as a property and is semantically incorporated into the predicate. However, a hearer can also interpret the indefinite as a free variable. In the latter case the indefinite needs to be bound by some antecedent in the discourse context and cannot be incorporated into the verb. Low indefinites (as in (14b)) are preferably interpreted as predicative. They are incorporated into the predicate, and (thus) take narrow scope with respect to the other scope taking element. The high indefinite in (14a), on the other hand, is interpreted as a free variable and takes wide scope over the negative operator.

As stated above, free variable indefinites (unlike predicative indefinites) need to be bound by some antecedent in the preceding discourse context. Interpreting high indefinites thus requires skills of "discourse integration". However, preschool children are known to have problems consistently integrating discourse. When children are asked to tell stories, discourse cohesion is nearly absent until about age 6 (Karmiloff-Smith, 1981, 1985). Four- and five-year olds generally do not use connective markers in their narratives, and often overuse pronouns and definite articles (Ibid.; Hickman 1982; Maratsos, 1976; Stenning and Mitchell, 1985).

Krämer (2000:82) hypothesized that children's non-targetlike discourse skills might prevent children from interpreting indefinites as free-variable indefinites. This is formalized in the Non-Integration Hypothesis in (15):

- (15) **Non-Integration Hypothesis:** The predicative interpretation of indefinites is acquired early. The free variable interpretation is acquired later because it requires discourse integration.

The Non-Integration Hypothesis is supported by experimental evidence. Krämer presented 38 Dutch-speaking children (4-8 years old) with a Truth-Value Judgment task in which they were asked to judge sentences like (14a) in a situation in which a boy catches two fish, but there is also a single fish that the boy does not catch. In order to judge the test sentence to be a true description of this experimental context, children need to derive a free-variable interpretation of the indefinite. This, however, is not what they did. Children rejected a sentence like (14a) as a description of this situation on 84 percent of the trials.⁵¹ An adult control group never performed this way. When children were presented with sentence (14b) in the same situation, they invariably performed like adults and rejected the test statement.

Similar results were obtained on an act-out task which tested sentences like (16) in which the scrambled indefinite object interacts with the frequency adverb *twee keer* ('twice').

- (16) *Je mag een potje twee keer omdraaien.*
 you may a jar two times turn
 'You may turn a jar twice'.

When presented with (16) adults generally turn a single jar twice. In contrast, about half of the child participants acted out this sentence by turning two different jars once. This suggests that children prefer to interpret the indefinite with narrow scope with respect to the frequency adverb. However, as we will see in section 3.7, this result has not been replicated in other tasks testing similar sentences. The results of the two experiments discussed above strongly suggest that children do not interpret high

⁵¹ However, the free-variable interpretation of high indefinites is not completely inaccessible to children. Unsworth, Gualmini and Helder (2008) have shown that, after certain contextual manipulations, children are able to derive the free-variable interpretation of high indefinites.

indefinites as free variables, but rather that they interpret them predicatively. The results are thus consistent with the Non-Integration Hypothesis.

If the Non-Integration Hypothesis is on the right track and the free-variable interpretation of indefinites is acquired late, then children are expected to fail to derive this interpretation in many different constructions and contexts. When presented with a sentence like *The bear gave a fox every cake*, adults interpret the indefinite in the indirect object position as a free-variable indefinite. If children cannot derive this free-variable interpretation, they will instead derive a predicative interpretation. In this case the indefinite is interpreted as a property and semantically incorporated into the verb. It would then take narrow scope relative to the universally quantified direct object DP (which undergoes Quantifier Raising). The sentence would thus be interpreted as: for every cake it is the case that the bear ‘gave-it-to-a-fox’. This is true in an ALL>ONE event in which every individual cake is given to a different fox. The Non-Integration Hypothesis thus correctly explains children’s acceptance of test sentences in ALL>ONE events.

However, when trying to explain children’s no-responses on ONE>ALL events, the entailment problem surfaces again (see section 2.5.1). As stated above, in the predicative, incorporated interpretation of the indefinite, the indefinite is interpreted with narrow scope relative to the other scope-taking element. However, as we have seen in chapter 2, in sentences like *The bear gave a fox every cake* the wide scope interpretation of the universal quantifier is entailed by wide scope of the indefinite. This implies that when the universal quantifier scopes over the indefinite it is a true description of both a fully distributive situation and a situation in which a single individual gets all the objects (e.g. the interpretation that would be derived if the indefinite were to be interpreted as a free variable). Krämer’s account thus predicts that children will accept the test sentences for both ONE>ALL and ALL>ONE events, and show the ambiguity response pattern. This, however, is an incorrect prediction, as more than half of the children reject test sentences describing ONE>ALL events.

To summarize, the above discussion shows that Krämer’s Non-Integration Hypothesis cannot be extended to account for the Reverse-pattern. In the next section we will formulate a new hypothesis based on Schwarzschild’s (2002) theory of indefinites. This account will relate the Reverse-pattern to a general deficiency in the interpretation of indefinites. This deficiency is not purely syntactico-semantic in nature, but also relates to the (pragmatic) restriction of the domain of indefinites.

3.4 *The Singleton Restriction Hypothesis*

In the previous section we have seen that Krämer's Non-Integration cannot be extended to capture the Reverse-pattern. If children cannot derive a free-variable interpretation of indefinites and opt for a predicative interpretation instead, then children should accept test sentences for both ALL>ONE and ONE>ALL events. In this section we will propose another account which argues that there is some more general problem with children's interpretation of indefinites, as opposed to a problem with the interpretation of one specific lexical item (e.g. the Modified Lexical Factor Hypothesis). This new account argues that children often fail to derive a source-set specific/partitive interpretation of indefinites because they fail to contextually restrict the domain of the indefinite to a singleton set when the discourse context includes multiple possible referents for the indefinite.⁵² The hypothesis proposed in this section, which will be referred to as the Singleton Restriction Hypothesis, is based on Schwarzschild's (2002) account of singular indefinites. We will therefore start out by discussing the main points of this account.

While the scope of most quantifiers is restricted by certain locality conditions, this does not hold for indefinites. One example of this exceptional wide scope property of indefinites is presented in (17). In (17a) the universal quantifier in the subject of the *if*-clause cannot scope out of this clause and take wide scope over the subject of the main clause. The only reading of this sentence is the reading where a certain girl will be sad if every horse falls ill. The sentence cannot mean that for every horse there is a (possibly different) girl that will be sad if that horse falls ill. Sentence (17b) on the other hand does allow scope interaction between the universally quantified subject of the main clause and the indefinite subject of the *if*-clause. The sentence can have a distributive interpretation where for every girl there is different horse that falls ill (causing that girl to be sad), but the interpretation where there is a specific horse that falls ill causing every girl to be sad (e.g. the interpretation believed to be derived through wide scope of the indefinite) is also available.

⁵² Indefinites can have multiple different interpretations. In this study we are mainly concerned with one type of specific interpretation, namely the source-set or partitive interpretation. These terms will be used interchangeably. An indefinite has this type of interpretation when it refers to a single element out of a larger set, a meaning that can also be expressed by using the explicit partitive 'one of the X'.

- (17) a. A girl will be sad if every horse falls ill.
 (adapted from Ebert and Endriss, 2004)
 b. Every girl will be sad if a horse falls ill.

The above example shows that while the scope of *every* is constrained by locality conditions and cannot escape the if-clause, the scope of the indefinite extends beyond the local domain. There have been many different ways of explaining this exceptional wide scope behaviour of the indefinite (see Abusch, 1994; Liu, 1997; Reinhart, 1995, 1997; Ruys, 1992; among many others). Fodor and Sag (1982), for instance, argued that indefinites are ambiguous between a quantificational reading and a referential interpretation. In exceptional scope environments in which the scope of the indefinite seems to escape from so-called scope islands (like the if-clause in (17)) the indefinite is in effect treated as a referential expression, and not as a quantifier. Schwarzschild (2002), on the other hand, presents an account in which exceptional wide scope indefinites are no different from other indefinites. All indefinites are existential quantifiers and their domain is both implicitly and explicitly restricted. However, when the domain of the indefinite is contextually restricted to a singleton domain, the indefinite essentially becomes scopeless. That is, scope is neutralized.

A specific indefinite, according to Schwarzschild, is an indefinite whose domain has been restricted to a singleton set. This can either be done explicitly (*A girl I know who has long black hair*), or implicitly.⁵³ In the case of implicit restriction the discourse context alone is responsible for restricting the indefinite in the intended way. Depending on the properties of the discourse context, this process of selecting a restriction for the indefinite could be trivially easy, but also relatively complicated. When the statement *A cat is eating cake* is uttered in a discourse context in which there is only a single cat available, the context strongly favours contextual restriction to a singleton set. Furthermore, deciding which individual should form the restriction of this singleton set is a trivial task, as there is only a single option. However, this is not always the case. When the same statement is presented in a situation in which there are multiple different cats and the intended interpretation of the indefinite article is a partitive or source-set interpretation, selecting a single individual element to form the restriction of the indefinite is slightly more complicated. That is, when a sentence like *A cat is eating cake* is uttered in a situation in which there are multiple cats and only one of them is eating cake, an interpreter needs to zoom in on the one cat that is in the process of eating cake and discard all the other cats (that

⁵³ However, when there is explicit restriction to a singleton set, the use of a definite determiner (*The girl I know who has long black hair*) may be felt to be more felicitous than the use of an indefinite.

could plausibly have been part of the restriction of the indefinite) in order to judge the sentence to be true. We will hypothesize that children's non-targetlike performance on double-object constructions results from a problem with this process of 'zooming in' on the relevant individual, or rather the process of restricting the indefinite to a singleton set when the intended interpretation is a source-set interpretation.

- (18) **Singleton Restriction Hypothesis:** Children fail to derive a source-set interpretation of indefinites, because they fail to restrict the domain of indefinites to a singleton set when the discourse context makes salient multiple possible referents for the indefinite.

However, the question now becomes why children fail to correctly restrict the indefinite and exactly how they fail. If we follow Schwarzschild (2002), all indefinites are contextually restricted and all of them are therefore anaphoric to discourse. One could thus argue that perhaps children's problem lies in this link to discourse or in the process of discourse integration, as Krämer (2000) argued. However, in this case we do not argue that children fall back on a predicative interpretation of the indefinite when a lack of discourse skills prevents them from deriving a specific interpretation of the indefinite, as in section 3.3 we have already shown that this does not explain children's non-targetlike performance. Rather, children fail to use discourse to limit the reference of the indefinite to a single individual in the discourse context. A second question is how children interpret the indefinite when they fail to derive a singleton domain restriction. Recall that when children judged ONE>ALL events to be false, they were generally able to justify their no-responses. They stated that ONE X got all the Y's. This suggests that children do assign a clear meaning to the test sentence. Furthermore, it suggests that instead of selecting a single individual, children consider a plural set, e.g. the set containing all individuals that could possibly have been part of the restriction. It is this property which Su (2001b) referred to when she hypothesized that the indefinite article is assigned a meaning similar to 'any', e.g. the universal quantificational force discussed in section 3.2.3.

Let us illustrate exactly how the Singleton Restriction Account would explain the Reverse-pattern. In ONE>ALL events, the indefinite is felicitous under its partitive interpretation, as it refers to one X out of a set of X's. In the case of the sentence *The bear gave a fox every cake*, the set of individuals who could be given a cake consisted of three foxes and a mouse. Since the test sentence is about foxes, and not mice, children should have no

problems ignoring the mouse when evaluating the test sentence. However, all of the foxes have participated in the story, and each of the foxes could plausibly have been given all of the cakes (in fact each of the foxes is offered cake). If children fail to use the discourse context to restrict the domain of the indefinite to a singleton set (i.e. to the fox that got all of the cakes), and instead end up with a set that contains all of the foxes in the discourse context, then they are expected to reject the test statements for ONE>ALL events. In a ONE>ALL event the test sentence is true for one of the foxes, but not for all of them. In ALL>ONE events all of the foxes are in fact involved, and the indefinite does not need to be restricted to one individual from this set. If children, in addition, do not have knowledge of scope freezing, then the Singleton Restriction account also captures children's YES-responses on ALL>ONE events.

If the Singleton Restriction Hypothesis is correct, then this first of all implies that the Reverse-pattern is not limited to a certain indefinite. Contextual restriction to a singleton set should apply to all singular indefinites. In other words, the Reverse-pattern is expected to occur with all singular indefinites. Furthermore, children should perform non-targetlike in all situations in which a source-set interpretation of the indefinite needs to be derived. When a sentence like *A mouse is wearing a hat* is used in a context in which there are multiple mice but only one is wearing a hat, children are predicted to often fail to derive the correct interpretation of the indefinite. When the Dutch sentence *Een kat springt twee keer over de vijver* (Lit. A cat jumps two times over the pond) is presented in a situation in which there are multiple cats who jump over things but only one jumps over the pond twice, children should perform non-targetlike. This prediction is investigated in section 3.8.

In the next sections we will first put the Modified Lexical Factor Hypothesis (see section 3.2.2) to the test by investigating children's interpretation of dative sentences containing the singular indefinite determiner *some* and the numeral *one*. According to the Modified LFH, the Reverse-pattern should be limited to sentences containing the indefinite article *a/an*, so when presented with *some* and *one* children should not show this performance pattern. The Singleton Restriction Hypothesis, on the other hand, would predict the Reverse-pattern to occur with singular indefinites in general. In other words, the Reverse-pattern should be observed when children judge dative sentences containing the singular indefinite determiner *some*. The predictions of the Singleton Restriction Hypothesis with regard to *one* are less clear. The numeral *one* can have a source-set interpretation (*one of the boys is doing X*) and when it is used in this way, a speaker must zoom in on a single boy and discard all of the other boys. In other words, the interpretation procedure would be similar, if not identical to the

interpretation procedure for (other) singular indefinites. We may thus expect children to also experience problems when deriving a source-set, partitive interpretation of the numeral. However, the numeral can also have a cardinal interpretation. To derive the cardinal interpretation of the numeral, children only need to evaluate the individual doing the action and determine whether it is indeed only a single individual. No attention needs to be paid to any other individuals in the context. In this case, no non-target-like performance is predicted on the Singleton Restriction Account.

3.5 Experiment II: Testing *Some* (singular)

Su's Lexical Factor Hypothesis and the Modified Lexical Factor Hypothesis both hold that the non-targetlike performance of the English and Dutch-speaking children is caused by children's non-targetlike understanding of a specific lexical item, e.g. the indefinite article *a/an* in English and *een* in Dutch.⁵⁴ This predicts that the Reverse-pattern should also be limited to that specific lexical item, and that when children are presented with sentences in which the indefinite article is replaced by another singular indefinite, they should not show the Reverse-pattern. The Singleton Restriction hypothesis on the other hand predicts non-targetlike performance in all situations in which a source-set interpretation of an indefinite needs to be derived, no matter whether the indefinite is *a/an* or some other singular indefinite.

In this experiment English-speaking children were presented with sentences like (19), i.e. double-object constructions containing the singular indefinite determiner *some*. This type of construction was only tested in English, because in Dutch there is no singular indefinite which differs minimally from the indefinite article.

(19) The bear gave some fox every cake.

If the Lexical Factor Hypothesis is on the right track, then children are predicted not to show the Reverse-pattern with these sentences.⁵⁵ Children

⁵⁴ Though the Lexical Factor Hypothesis in its original formulation only applies to English, this study assumes that it can also be extended to Dutch. That is, we assume that Dutch children also assign non-overlapping meanings to the indefinite article *een* ('a/an') and the numeral *één* ('one').

⁵⁵ Unless, of course children assign the same meaning to the indefinite article *a/an* and the indefinite determiner *some* (singular). However, Mutual Exclusivity would block this.

will either perform targetlike, or (possibly) show a different non-targetlike performance pattern (that is, they may accept test sentences in both ONE>ALL and ALL>ONE events). The Singleton Restriction account, on the other hand, predicts that when sentences like (19) and similar sentences containing the indefinite article *a/an* are presented in the same discourse context (e.g. a ONE>ALL event in which to arrive at a ‘specific’ interpretation children need to contextually restrict the indefinite to a single individual from a set of similar individuals), children will show the Reverse-pattern with both indefinites. Before turning to the experiment itself, the differences and similarities between the indefinite article *a/an* and the indefinite determiner *some* (singular) will be investigated.

3.5.1 *Some* (singular) vs *a/an*

Both the (singular) indefinite determiner *some* and the indefinite article *a/an* combine with a singular DP (*some man*, *a man*). They also both ‘support cross-sentential anaphora’, as shown in (20).

- (20) a. A man_i called. He_i wanted to talk to you.
 b. Some man_i (or other) called. He_i wanted to talk to you.

Furthermore, *some* and *a/an* can have both a dependent and an independent reading when they occur within the scope of another quantifier. That is, a sentence like (21) is ambiguous between ‘Mary said that there is a certain book that every girl often reads’, and ‘Mary said that for every girl there is a (possibly different) book that she often reads’.

- (21) Mary said that every girl often reads some book
 (a certain book, or a different one).

However, there are also some crucial differences between the two indefinites. For instance, while the indefinite article *a/an* can have a generic-type interpretation in certain environments (see Cohen, 2001), *some* (singular) can never be interpreted generically.

- (22) a. A cat catches mice
 (possible interpretation: generally cats catch mice)
 b. Some cat catches mice (≠ generally cats catch mice)

The indefinite *a/an* can be bound by an adverb of quantification, but *some* cannot.

- (23) a. Usually a student is smart.
b. #Usually some student is smart

Unlike *a/an*, *some* is not predicative:

- (24) a. Hans is a boy
b. #Hans is some boy.

The unacceptability of the b-sentences in (22)-(24) suggests that *some* (singular), unlike *a/an*, is lexically specific. In a sense *some* acts like a proper noun. Proper nouns cannot be bound by an adverb of quantification either, or be used predicatively, as the sentences in (25) show.

- (25) a. #Usually John is smart.
b. #Hans is John.

Furthermore, there is another semantic difference between the two determiners which relates to the contexts in which the use of the determiners is felicitous. Using *some* often seems to entail that the speaker either does not know or does not care what the identity of the referent of the DP headed by *some* is (Strawson, 1974). This property of *some* is illustrated in sentence (26).

- (26) Some cabinet minister has been shot: #Who?

The infelicity of the follow-up question suggests that *some cabinet minister* refers to ‘a cabinet minister whose identity I (the speaker) do not know, or whose identity is irrelevant for the purpose of this statement’. Farkas (1994) named this property *epistemic non-specificity*.⁵⁶ *A/an* is generally not used in this way. In addition, for many adults the use of *some* (singular) has negative connotations. It is not only used in situations in which the speaker does not know or care about the identity of the person or object that is referred to (e.g. epistemic non-specificity), but it is also sometimes used to signal contempt or a negative attitude towards the referent of the indefinite DP. We will call this type of usage pejorative usage.

⁵⁶ This term is rather misleading, given that *some* (singular) is a lexically specific indefinite. Epistemic non-specificity implies that though the DP headed by the indefinite does refer to a specific person or object, the exact identity remains undisclosed.

To summarize, though *a/an* and *some* are both singular indefinites and share some (morpho-) syntactic properties, the two indefinites differ in their meaning. *Some* is not only lexically specific, but also has the property of epistemic non-specificity. In addition it is often used pejoratively. In the next sections an experiment will be described in which children and adults were presented with double-object constructions containing the singular indefinite determiner *some*. It will be shown that at least for adults the negative connotations of *some* occasionally interfere with their judgments.

3.5.2 Participants

The participants in this study were 28 English-speaking children, who were drawn from various day care centres in Canada (the Toronto and Montreal-areas), see table 1 for age statistics. Only children whose dominant language was English were included. A group of adults was included as a control group. All of the adult controls were undergraduate students at McGill University. Some of them were first-year linguistics students.

group	N	age range	mean age	#male	#female
children	28	3;8-5;10	4;10	11	17
adults	8	18-24	20	3	5

Table 1: Participant Statistics SOME-Experiment

3.5.3 Design and Procedure

The task was a Truth-Value Judgment task with picture stories. All of the children were tested on two types of indefinite, the indefinite determiner *some* and the indefinite article *a/an*. Each of the indefinites was presented in the two familiar situation types: a ONE>ALL event in which a single character got all of the objects, and an ALL>ONE event, in which the objects were distributed evenly over the characters. In effect there were thus four distinct conditions (Some-ONE>ALL, Some-ALL>ONE, A-ONE>ALL and A-ALL>ONE).

The design of the study was within-participants; all children saw all test conditions. There were two trials of each condition containing *some*, while there was only one instance of each condition testing *a/an*. The SOME-trials always preceded the A-trial. In each case the DP headed by the indefinite would refer to one individual of a set of similar individuals, for instance one out of a set of foxes. In other words, the indefinites would be felicitous on their partitive reading. Making the indefinite determiner *some* felicitous required some more effort. As established in section 3.5.1, the epistemic

indefinite is in principle felicitous when the speaker does not know which individual(s) the DP headed by *some* refers to (or does not care).⁵⁷ In the contexts used in this experiment the identity of the characters which are the ‘recipients’ of the action is unknown to the individual uttering the test statement (i.e. a handpuppet). That is, though the puppet knows that there are multiple characters of a certain type, he does not know which of the characters end up being given a cake, fed an apple etc. In addition, children were told and shown that the handpuppet was very bad at listening to stories, making it more likely that he really would not know which individual or individuals were recipients of the action. These two design features should make it felicitous for the puppet to use *some* in his utterances.

The experiment also included two control conditions, as well as a selection of filler and warm-up items. The first control condition (Quantifier-controls) tested children’s knowledge of universal quantification by presenting them with simple statements of the form: *all/every/each X Verb-ed Y* in situations in which either all of the Xs, or only a subset of them had the property described by the predicate. The second control condition tested children’s interpretation of simple statements containing *some* (SOME-controls). For instance, children would be presented with a sentence like *Some mouse is wearing a hat* in a situation in which one of three mice was wearing a hat.

A group of adult participants also saw the experimental materials. These adults were tested in small groups, without a puppet. They were asked to write down their judgments on answer sheets themselves.

3.5.4 Materials

There were four different test stories, each testing a different predicate. The ordering of the stories was counterbalanced across participants. Each story contained both a ONE>ALL and an ALL>ONE situation. In half of the stories the ALL>ONE situation preceded the ONE>ALL situation, and in the other half the ordering of situations was reversed. The same stories were used for the A/AN- and SOME-conditions. A sample story is presented below:

⁵⁷ This is the epistemic non-specificity property of *some*.

A girl and her dog are at the zoo. The girl has brought three apples to feed to the animals. The girl and the dog first see three giraffes and a zebra. The girl first feeds this giraffe (giraffe 1) an apple. Then she feeds the second giraffe an apple. She also wants to feed the third giraffe an apple, but then the zebra would not get anything. She feels her pocket to see whether she may have some other nice food. In her pocket she finds a cookie. She feeds the zebra the cookie. The final giraffe gets the apple (=ALL>ONE event).

Test statement: *The girl fed a/some giraffe every apple.*

In her basket the girl also has three bananas which she wants to feed to three monkeys. Monkey 1 does not like bananas and covers his mouth with his hands. The second monkey also does not like bananas and turns away. The girl states that monkeys must not like bananas that much, and offers them to her dog. Her dog does not want them either. The third monkey does really want them, and thus the girl feeds him all three bananas (=ONE>ALL event).

Test statement: *The girl gave a/some monkey every banana.*

3.5.5 Results

3.5.5.1 Group Results

Table 2 below presents the mean percentages of child participants and adult controls who judged SOME- and A/AN-trials to be true. These same results are also presented in graph 1 below:

group	indefinite	N trials	event	% true
children	some	56	one>all	44.6
		56	all>one	62.5
	a/an	26	one>all	65.4
		26	all>one	73.1
adults	some	16	one>all	87.5
		16	all>one	62.5
	a/an	8	one>all	100
		8	all>one	37.5

Table 2: Percentage Truth-Judgments Child and Adult Participants

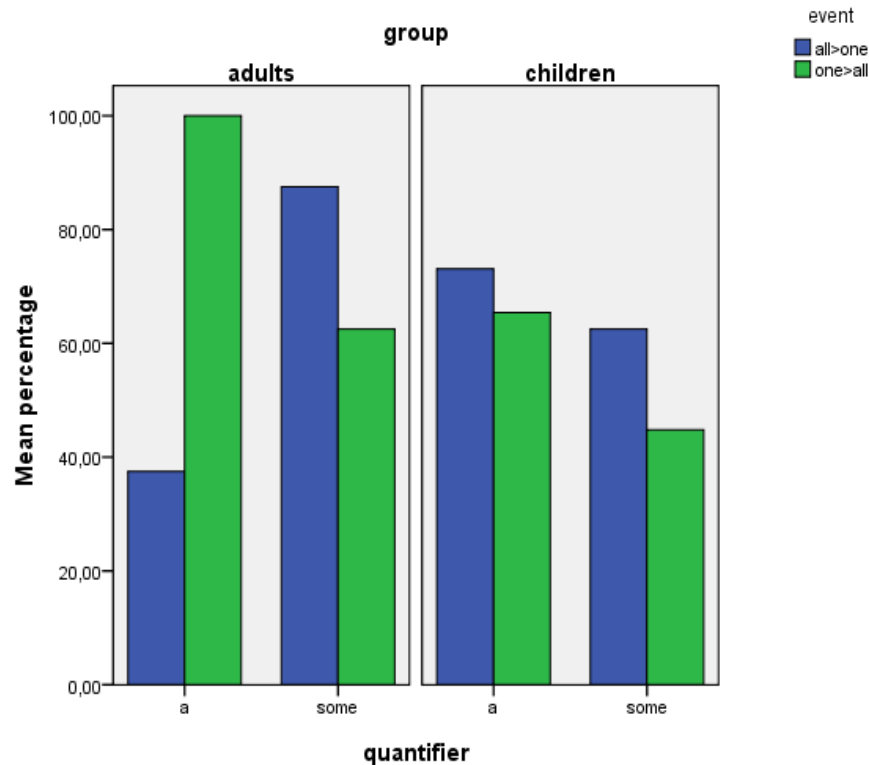

Graph 1: Percentages Truth Judgments Children and Adults

Children who perform targetlike would accept test sentences in ONE>ALL events and reject them in ALL>ONE events. However, the results show that children accepted test sentences containing *some* only 44.6% of the time for ONE>ALL events. Furthermore, when we consider ALL>ONE events, we see that only 37.5% of the participants rejected test statements for this event-type. Many children thus performed non-targetlike on the SOME-trials. For the A/AN-trials children's performance was also decidedly non-targetlike: 69.2% of the children correctly accept test sentence in ONE>ALL events, but at the same time 73.1% of the children accept test sentences in ALL>ONE events.

A more detailed look at the raw data suggests that (i) many children judge both test statements to be true, (ii) on the SOME-sentences children are not consistent in their judgments across trials. It could be that children whose performance pattern was not consistent across trials of the SOME-conditions performed this way because they had problems with the

interpretation of the universal quantifiers or the indefinites that were used in the test sentences. Therefore, children who failed more than 2 control conditions (quantifier-controls or indefinite-controls) were excluded.⁵⁸ This criterion caused 5 children to be excluded from analysis. The remaining 23 children are between 3; 8 and 5; 10 years old (mean age 4; 10). This group consists of 14 girls and 9 boys. However, as table 3 shows, excluding children who failed many controls does not alter the results significantly (compared to table 2). The only difference is that there is a reduced acceptance of test sentences containing the indefinite article *a/an* in ALL>ONE events.

group	indefinite	event	% true
children	some	one>all	41.3
		all>one	63
	a/an	one>all	68.2
		all>one	59.1

Table 3: Responses Included Child Participants

When the adult control group (see table 2) was presented with test sentences containing the indefinite article *a/an* in a ONE>ALL situation, they always accepted the test statement. However, in the ALL>ONE situation, only 62.5% of the adults rejected the test statement. For the sentences testing *some* the results are rather puzzling. Though there is a slight tendency for adults to accept the test sentences in ONE>ALL events (58.7%), many adults also judge the test sentences to be true in ALL>ONE events (62.5%). Adults thus do not perform as expected on the test sentences containing *some*. In section 3.5.6 we will consider some possible explanations for this non-targetlike performance.⁵⁹

⁵⁸ A large proportion of the Quantifier-controls asked children to judge statements like *Every X is a certain colour*. Since it is well-known that many preschool children still have problems with colour naming (see for instance Bornstein, 1985) these items were not used to determine whether a child was included or excluded.

⁵⁹ Note that in this dissertation we use the term targetlike performance to refer to performance that conforms to the predictions of linguistic theory. Generally speaking adults should perform targetlike. However, this is not always the case. In other words, targetlike performance is not necessarily the same as adultlike performance.

3.5.5.2 Individual Results

The children (all of the 28 children who were originally tested) were classified according to the individual response patterns they showed. For children to be classified as belonging to a certain pattern they had to show this pattern 100 percent of the time. For the SOME-sentences this meant that they needed to be consistent on both trials of the conditions. However, table 4 also presents the total number of children who showed a certain performance pattern in just one of the stories of the (SOME) experiment.⁶⁰ There was only one trial for each condition containing the indefinite article *a/an*, therefore children's performance on those trials automatically determined their classification.

ONE-ALL	ALL-ONE	PATTERN	SOME (all trials)	SOME (one story)	A/AN
false	true	reverse	4	20	7
true	true	ambiguity	3	14	10
true	false	targetlike	0	13	6
mixed/unclear	mixed/unclear	unclear	21	9 ⁶¹	5 ⁶²

Table 4: Individual Response Patterns Children

A group of four children showed the Reverse-pattern on both of the trials of the SOME-conditions, but 20 out of the 28 children performed this way on at least one of the trials. Three children consistently showed an Ambiguity pattern (a performance pattern which 14 children showed on at least one of the trials). None of the children consistently performed targetlike, but 13 children showed a targetlike pattern some of the time. The Reverse-pattern is also observed for the A/AN-conditions, albeit less often than in previous experiments, e.g. only seven children showed the Reverse-pattern (four of these children showed the Reverse-pattern on some of the trials of the SOME-conditions). An ambiguity pattern was observed with ten of the children. Six children performed targetlike.

⁶⁰ Each test story comprised of both an ALL>ONE event and a ONE>ALL event. We determined for each story which response pattern children displayed within that story.

⁶¹ The children in this group either missed one trial, or judged the test sentences to be false in both conditions.

⁶² Three of these children judged test statements to be false for both ONE>ALL and ALL>ONE events. Two did not judge both event-types.

When we look at the adult control group, we see that on the SOME-conditions three adults displayed the targetlike pattern, four of them showed the ambiguity pattern and one adult displayed the Reverse-pattern. On the A-conditions five adults performed targetlike, while three showed the ambiguity pattern.

3.5.6 Discussion

According to the Modified Lexical Factor Hypothesis the Reverse-pattern is caused by incomplete acquisition of the meaning of the indefinite article *a/an*, and should not occur when children are presented with sentences that contain other indefinites. However, the individual results show that in fact children do show the Reverse-pattern in sentences in which the singular indefinite determiner *some* is used, though their performance is not consistent across trials. At the same time, there were also many children who showed an ambiguity pattern or a targetlike pattern on some of the trials.

These three patterns are also observed for the adult control group (at least on the SOME-conditions). In fact the performance of the adult participants was unexpected. If scope freezing is a strong constraint on the interpretation of doubly-quantified double-object constructions, then we would expect all adults to reject the test statements in ALL>ONE events and accept them in ONE>ALL events. However, this is not the case. Only three out of the eight adults consistently performed this way.

In section 3.5.1 we discussed properties of the indefinite determiner *some*. It was noted that it had negative connotations (e.g. pejorative usage and epistemic non-specificity) and that the use of this determiner was subject to felicity conditions which differed from the felicity conditions on *a/an*. So perhaps the results for five of the adults represent performance errors due to, in their view, infelicitous use of the indefinite determiner in the test sentences. It is often difficult to test adults on this type of off-line Truth-Value Judgment task. For many adults, judgements of appropriateness seem to interfere with (or even override) judgements of grammaticality. That is, adult performance is often difficult to gauge because many adults do not merely evaluate whether a statement is a true description of a situation, but rather evaluate whether it is the optimal way to describe what happens in this situation. The test sentences presented in this experiment could have been uttered using a different indefinite (e.g. *a/an*) which would not have the negative connotations and felicity issues that *some* has, and which would thus have been a more optimal choice. However, if this was really an issue, then would we not expect adults to reject the *some*-sentences? This is not what we see, as adults seem more willing to accept test sentences in the

SOME-conditions than predicted, and in fact accept test sentences containing *some* to a higher degree than test sentences containing *a/an*.⁶³ Another possibility is that perhaps adults find *some* (singular) infelicitous and thus proceed to parse the test sentence with plural *some* (e.g. *some foxes*). If adults expect to encounter plural *some*, then the absence of plural morphology would make them run into a garden path, and cause the interpretation to crash. Adults would then end up with no interpretation at all. This could lead them to accept test statements because a yes-response makes the least commitments (Grimshaw and Rosen, 1990). If, they would instead (continue to) interpret the test sentence as *The bear gave some foxes every cake* (and thus ignore the lack of plural morphology), then they would be predicted to accept test statements in ALL>ONE events, but reject them in ONE>ALL events (and thus to show the Reverse Pattern). This, however, is not what we observe. A final possibility is that perhaps the degree to which Scope Freezing applies depends on the specific lexical items involved. Perhaps in a sentence containing *some* inverse scope is for some reason or other more accessible than in sentences containing the indefinite article *a/an*, a possibility which is consistent with Goldberg's Information-Structural Account of Scope Freezing. Unfortunately, the small sample size of the adult control group does not allow us to draw firm conclusions. Future research is required to shed more light on this.

The performance of the children participating in this experiment was much less consistent than the performance reported in previous experiments testing children's interpretation of similar sentences with the indefinite article *a/an*. One possibility is that, just like for adults, children's poor performance on *some* relates to the specific conditions under which the use of this indefinite is felicitous. However, this argument is undermined by the fact children had no problems correctly interpreting *some* in other sentence types. This experiment also contained SOME-control items, e.g. statements containing the epistemic indefinite determiner *some* in a situation in which only a partitive interpretation would make the indefinite true (e.g. *Some mouse is wearing a hat*, when one out of three mice was wearing a hat). Children were 82.2 percent accurate on these control items. Only five children failed more than one of the control items. As a matter of fact, these five children were the ones that were excluded from analysis in section 3.5.5.1, and whose removal from the data set did not alter the results.

⁶³ In fact the amount of yes-responses for the A/AN-conditions was quite high in this experiment as well, though this can in part be attributed to carry-over effects since the A/AN-trials were always presented after the SOME-trials.

However, the children participating in this study were relatively young (3; 8-5;10, mean age 4;10), while in previous studies the children were slightly older (mean age 5;5). Perhaps age effects could explain children's inconsistent performance. However, none of the previous studies ever found an age effect on children's performance (although in chapter 4 we will see that younger children do tend to show the Ambiguity-pattern more often than older children). Furthermore, in this experiment it is not the case that the younger children perform worse than the older children

To summarize, the Reverse-pattern is not limited to sentences with the indefinite article *a/an*, as it is also observed in sentences testing the indefinite determiner *some*. The results presented above thus present counterevidence for the Modified Lexical Factor Hypothesis, even though children and adults were not always consistent in their responses. However, a stronger argument could be found in investigating children's interpretation of the numeral *one*. The (Modified) Lexical Factor Hypothesis did not make specific predictions about which meaning children assign to *some*, leaving open the possibility that children would assign a meaning to *some* which would also lead children to show the Reverse Pattern (see fn. 43). However, the (Modified) LFH does make specific predictions about the meaning children assign to a numeral like *one*.

3.6 Experiment III: Testing the Numeral

In the previous section we saw that one of the predictions of the Modified LFH was not borne out. Children still showed the Reverse-pattern when they were presented with test sentences which contained the indefinite *some*. However, the Modified Lexical Factor Hypothesis makes another prediction, namely that English-speaking children would interpret *one* as meaning 'exactly one'. This prediction is tested in this second experiment by presenting both English and Dutch-speaking children with sentences like (27):

- (27)
- a. The bear gave **one** fox every piece of cake.
 - b. *De beer heeft één vos elk stuk taart gegeven.*
the bear has one fox every piece (of) cake given
'The bear gave one fox every piece of cake'

If children indeed interpret *one* (and Dutch *één*) as meaning 'exactly one', then they should accept the test statements as descriptions of ONE>ALL events, as it is indeed the case that one fox gets every piece of cake. When children are presented with ALL>ONE events, they are predicted to reject the test statement. This could be because they have

knowledge of Scope Freezing and thus disallow the (universal wide scope) interpretation which can be paraphrased as: for every piece of cake there is exactly one fox that the bear gave it to. However, other possible interpretation strategies would also predict this performance (for more discussion, see section 3.6.5).

3.6.1 Participants

23 Dutch-speaking children drawn from two preschools in the Utrecht area, and 36 English-speaking children drawn from a number of day care centres in Toronto and Montreal (Canada) took part in the experiment. Furthermore, nine English-speaking adult controls and seven Dutch-speaking adult controls were presented with a selection of stories from the experiment. The English-speaking adults were all undergraduates at McGill University. Some of them were first year linguistics students. The Dutch-speaking adults came from more varied backgrounds. A number of them were students, but none were students of linguistics. The participant statistics can be found in table 5.

group	language	N	age range (yrs; mos)	mean age	#male	#female
children	Dutch	23	4;2-6;9	5;4	9	14
adults	Dutch	7	16-45	24	3	4
children	English	36	3;8-5;10	4;9	16	20
adults	English	9	18-26	21	3	6

Table 5: Participant Statistics Numeral Experiment

3.6.2 Design

The participants were again tested with a version of the Truth-Value Judgment task. The Dutch-speaking children were presented with a replication of the experiment presented in chapter 2, the only difference being the fact that the indefinite article was replaced by the numeral *één*. The English-speaking children were presented with only a single story from this experiment.⁶⁴

The Dutch experiment did not just test double-object datives (DO-Dat). Rather, it also tested simple *to*-datives (PP-Dat) and scrambled *to*-

⁶⁴ The English experiment was smaller than the Dutch experiment because it was included in a larger experiment which investigated another linguistic phenomenon.

datives (SPP-Dat). However, sentence type was a between-subjects factor. Examples of the sentence types tested are presented in (28) below:

- (28) a. DO-Dat (one>>∀, *∀>>one)
De beer heeft één vos elk stuk taart gegeven
 the bear has one fox every piece of cake given
 ‘The bear gave one fox every piece of cake’
- b. PP-Dat (one>>∀, ∀>>one)
De beer heeft elk stuk taart aan één vos gegeven
 the bear has every piece of cake to one fox given
 ‘The bear gave every piece of cake to one fox’
- c. SPP-Dat (one>>∀, *∀>>one)
De beer heeft aan één vos elk stuk taart gegeven
 the bear has to one fox every piece of cake given

The English-speaking children were only tested on the DO-Dat construction, see (28a). Each sentence type was presented in two event-types, ONE>ALL events (one fox gets all the pieces of cake) and ALL>ONE events (each fox gets a piece of cake).

The Dutch experiment included a total of three different dative-stories, each of which tested a different predicate. The Dutch-speaking children saw all stories (the ordering of which was counterbalanced across participants). The English-speaking children, in contrast, saw only one story, but not every child saw the same one. The set-up of the test stories was the same as the stories used in previous experiments. The procedure of this experiment was also identical to the procedure used in the experiment described in the previous section.

The English-speaking adult participants were tested in small groups, without the aid of a puppet. A single experimenter would read out the stories to the adults while showing them the pictures. The adults were given answer sheets. At certain points in the story the experimenter would stop and ask the adults to judge whether the statement was true or false and to circle the corresponding response on the answer sheet. Like the children, the English-speaking adults were only presented with a single dative story. The Dutch-speaking adult participants were tested individually. A single experimenter would read out the stories and also read out the test statements (without using a puppet). The Dutch-speaking adults would tell the experimenter whether they thought the statements were true or not. The experimenter would note their responses on an answer sheet.

3.6.3 Results

3.6.3.1 Results Dutch

	children				adults			
	one>all		all>one		one> all		all> one	
	%true	%false	%true	%false	%true	%false	%true	%false
DO-Dat	94.4	5.6	47.4	52.6	90.5	9.5	0	100
PP-Dat	77.2	22.8	31.8	68.2	--	--	--	--
SPP-Dat	75	25	46	54	--	--	--	--

Table 6: Results Dutch-speaking Participants

The Dutch-speaking children accepted the test statements as a description of ONE>ALL events to a high degree (75-94.4% of the time depending on the dative-construction). Furthermore, they also rejected the test statements as descriptions of ALL>ONE events between 52 and 68 percent of the time. In other words, children's performance on this experiment appears to be significantly more targetlike than children's performance on test sentences containing the indefinite article *een* (Experiment 1, chapter 2: 31.2% correct acceptance ONE>ALL events, 24.3% correct rejection ALL>ONE events). There are differences between the sentence types. However, these differences are not significant ($p \geq .05$).

The adult participants always rejected the test sentences as descriptions of an ALL>ONE event. Furthermore, adults accepted the test sentences for ONE>ALL events 90.5 percent of the time. Most adults thus performed targetlike.

Next we turn to children's individual response patterns, which are presented in table 7 below. In the case of the DO-dat and the PP-dat condition, forty percent of the child participants performed targetlike and thus rejected ALL>ONE events and accepted ONE>ALL events. This is a significantly higher percentage than the 18.5% reported in chapter 2 for sentences containing the indefinite article *a/an*. Interestingly, 62.5 % of the children who were presented with the PP-dat condition also showed the frozen scope pattern, and thus rejected test sentences in ALL>ONE events. Generally *to*-datives are assumed to be ambiguous, and children were thus expected to show the Ambiguity-pattern on that condition. Only two children in total showed the Reverse-pattern (one for SPP-dat and one for PP-dat), whereas in previous experiments (see chapter 2 section 2.4.4.2) between 28

and 52% of the participants were classified as displaying this performance pattern. About 20% of the participants accepted test statements for both event types (26.7 percent for DO-dat/PP-dat and 12.5 percent for SPP-dat), and thus showed the Ambiguity-pattern.

pattern	DO-dat, SPP-dat		PP-dat	
	N	%	N	%
reverse	1	6.7	1	12.5
ambiguity	4	26.7	1	12.5
frozen scope	6	40	5	62.5
unclear	4	26.7	1	12.5

Table 7: Individual Results Dutch-speaking Children

3.6.3.2 Results English-Speaking Children

group	event	%true
children	one>all	61.1
	all>one	58.3
adults	one>all	100
	all>one	0

Table 8: Results English-speaking Children

English-speaking children accepted the DO-DAT test sentence 61.1% of the time as a description of a ONE>ALL event, and rejected test sentences 41.7% of the time in ALL>ONE events. The control group of English-speaking adults always accepted the test statement in ONE>ALL events, and always rejected the test statement in ALL>ONE events.

When we look at the individual responses of the children, we see that eight of the children (e.g. 22.2%) display the Reverse-pattern. At the same time, nearly 20% of the children (N=7) perform targetlike. Seven children rejected test sentences in both ALL>ONE and ONE>ALL events and are classified in the ‘unclear’ category. We do not know which meanings these children assign to the test sentences, or whether these children perhaps switched interpretation strategies during the experiment.

pattern	N	%
reverse	8	22.2
ambiguity	14	38.9
frozen scope	7	19.4
unclear	7	19.4

Table 9: Individual Results English-Speaking Children on *one*

If we compare the percentages of children who show a certain performance pattern with *one* with the results on the A/AN-trials in experiment II (presented in table 10 below, see also table 4) we see that in fact the percentages are highly comparable.

Pattern	N	%
Reverse	6	21.4
Ambiguity	10	35.7
Targetlike	7	25
Unclear	5	17.9

Table 10: Individual Results English-Speaking Children on *a/an*

3.6.4 Discussion

The Modified Lexical Factor Hypothesis predicted that children should not show the Reverse-pattern when presented with dative sentences in which the indirect object was headed by a numeral like English *one* or Dutch *één*. Children should take these numerals to mean ‘exactly one’ and show a performance pattern which is similar to the performance pattern reported for the Chinese children in Su (2001b). However, the results of the above experiments show that in fact the Reverse-pattern is observed with these sentence types. More than 20 percent of the English-speaking children and 2 of the Dutch-speaking children (i.e. 8.6 percent) consistently displayed this non-targetlike behaviour. However, there were differences between the two languages. When Dutch-speaking children were presented with sentences like (28a-c), their performance was (significantly) more targetlike than when they were presented with similar sentences containing the Dutch indefinite determiner *een* (compare the above results with the results reported in chapter 2, section 2.4.4.) When English-speaking children were presented with sentences like (28a) their performance was highly similar to the performance reported for sentences containing the indefinite article *a/an* (see experiment II).

The first point of discussion is why Dutch and English-speaking children differed in the degree to which they showed the Reverse-pattern.

Whereas only 2 out of 23 Dutch children rejected ONE>ALL events and accepted ALL>ONE events, 8 out of 36 of the English-speaking children did so. Furthermore, whereas 20 percent of the English-speaking children performed targetlike, nearly half of the Dutch participants did so. One difference between the two groups is that the Dutch-speaking children were slightly older than the English-speaking children. The Dutch group was on average 5 years and 4 months old, the mean age English-speaking group was 4 years and 9 months. However, there is also a salient difference between the two languages that could explain it. In Dutch the numeral *één* is in fact the stressed indefinite article.⁶⁵ In English the indefinite and the numeral are completely distinct lexical items, neither of which is stressed in the test sentences. The stress on the Dutch numeral may have made this lexical item more salient to the Dutch-speaking children and may have enforced a tendency to look for a salient singleton individual in the story contexts.⁶⁶ This hypothesis is supported by the fact that Dutch children (and adults) who were presented with *to*-datives tended to reject test sentences containing the numeral in ALL>ONE events. Generally, *to*-datives are assumed to be ambiguous, and the universal quantifier should thus be able to take wide scope. The test sentences should thus be true in ALL>ONE events. However, more than sixty percent of the children (and all of the adult participants) only allowed the sentence to mean that a single character got all of the objects.

A second point of discussion is why Dutch children performed so much more targetlike on sentences containing the numeral than on sentences containing the indefinite article? When presented with the numeral, nearly half of the participants (47.8 percent) performed targetlike, and thus accepted test statements on ONE>ALL events and rejected them in ALL>ONE events. However, when they were presented with the indefinite article, only 10 percent of the children performed this way (see chapter 2). Have all those children who perform targetlike on the numeral sentences acquired the Frozen Scope Constraint or could something else be going on?

⁶⁵ The assumption that *één* is the stressed indefinite is not uncontroversial, since there are cases in which the indefinite article can be stressed without necessarily taking on the meaning of the numeral. What is important for the argument presented above is that Dutch *één* is for some reason or other more salient than the indefinite article and that it is this saliency which is hypothesised to explain the fact that Dutch children perform differently on sentences containing the numeral and sentences containing the indefinite article.

⁶⁶ However, previous research has shown that children are typically bad at using differences in prosody and contrastive stress for utterance interpretation (Solan, 1980; McDaniel and Maxfield, 1992; Halbert et al, 1995; among others), so stress may not actually help children much.

It is important to note that in this case targetlike performance is not necessarily the result of children's obedience of this constraint. In fact, other interpretation strategies would also lead children to show a similar performance pattern, for instance a strategy in which children scan the picture for a salient singleton individual. In ONE>ALL events such an individual is present, e.g. the one individual ending up with all of the objects. In ALL>ONE events no such individual is present, as all individuals are paired with an object.

3.7 Intermediate Conclusion

The Modified Lexical Factor Hypothesis predicted that children should not show the Reverse-pattern with sentences in which the indefinite article has been replaced by the singular indefinite determiner *some*, or the numeral *one*. However, it turns out that the Reverse-pattern does in fact occur with both (though with different frequencies). Therefore, we reject the Modified Lexical Factor Hypothesis as a plausible explanation of the Reverse-pattern. This pattern is not limited to sentences containing the indefinite article *a/an*, and hence a specific delay in the acquisition of the meaning of this lexical item cannot explain it.

However, *some* and the numeral *one* are also indefinites. The Reverse-pattern could be the result of some more general problem affecting all indefinites. In the next section we discuss an experiment which tests a prediction of the Singleton Restriction account (see section 3.4). This account claims that children are unable to arrive at a specific interpretation of the indefinite in question because in some contexts they are unable to contextually restrict the domain of the indefinite to a singleton element. The contexts in which children are hypothesized to experience problems are those contexts in which the indefinite needs to refer to one individual out of a set of similar individuals. This predicts that children's problems restricting the domain of the indefinite should also be observable with sentences in which the indefinite does not interact with a universal quantifier, but with, for instance, the frequency adverb *twice*. That is, as long as the domain for the indefinite is similar to the domain in the contexts used in previous experiments, and as long as the correct interpretation of the sentence depends on children's ability to restrict the indefinite to a singleton set, non-targetlike performance should be observed.

3.8 Experiment IV: TWICE

The Singleton Restriction account as discussed in section 3.4 hypothesizes that children may fail to restrict the indefinite to a singleton set in situations in which the context makes salient multiple possible individuals. In order to test whether this is the case, it is not sufficient to replace the indefinite article *a/an* with another indefinite, but the Singleton Restriction account could be put to the test by presenting children with sentences in which an indefinite interacts with another scope taking element, for instance the frequency adverb *twee keer* ‘twice’. The singleton restriction account predicts that if sentence (29) is presented in a context in which one cat (out of a set of three similar cats) jumps over the pond twice, children should still experience problems restricting the indefinite to one out of the three cats.

- (29) *Een kat is twee keer over de vijver gesprongen.*
 a cat is two times over the pond jumped
 ‘A cat jumped over the pond twice’

The construction in (29) has been investigated multiple times, mainly to see whether children have acquired the scope constraint which is operative in Dutch sentences with an indefinite subject (see for instance Philip and Termeer, 2003; Krämer, 2000, and the discussion in chapter 2 section 2.3). However, the results of different studies in this area are not at all uniform. While Krämer (2000) reports non-targetlike performance on act-out tasks (as discussed in section 3.3), studies using a Truth-Value Judgment task have revealed more targetlike performance (Philip and Termeer, 2003; Flobbe et al., 2008).

3.8.1 Participants

The experiment was conducted at a single preschool in the Utrecht-area with 38 Dutch-speaking children. The children were between 4;0 and 6;7 years old (mean age 5;6). The sample included 16 boys and 22 girls.

3.8.2 Design and Procedure

The experiment tested children’s interpretation of sentences like (29) in a Truth-Value Judgment task. The test sentences were presented in two distinct situation types:

- (30) TWO-CAT: a situation in which two (out of three cats) jumped over something.
 ONE-CAT: a situation in which one of the cats jumped over something twice.

The task thus contained two test conditions. Children saw only one trial of each of the conditions. The TWO-CAT situation always preceded the ONE-CAT situation. Children who perform targetlike should reject the test sentence as a description of a TWO-CAT situation, and accept it as a description of a ONE-CAT situation. The test items were embedded in a story about three cats and a dog, which goes as follows:

Three cats and a dog are playing in a garden in which there are a large stone, a fence and a pond. One of the cats boasts that he can jump really far and really high. The other animals say that they can do that too. They decide to hold a competition to see who the best jumper is. One of the cats jumps over the stone. Another cat thinks he can do better and also jumps over the stone, and because he is not tired yet he also jumps over a fence.

Test statement: *Een kat is twee keer over de steen gesprongen.*⁶⁷
 a cat is two times over the stone jumped
 ‘A cat has jumped over the stone twice’

⁶⁷ Bill Philip (p.c.) has argued that the presence of a definite article in the test sentences could be a significant factor and that perhaps the results could be different if we had tested sentences like (i) in which there is a second indefinite article:

- (i) *Een kat is twee keer over een steen gesprongen.*
 A cat is two times over a stone jumped.

Intuitively the scope constraint which forces a wide scope interpretation seems to be less strong in this type of sentence. That is, I personally find it easier to arrive at an interpretation in which different cats jumped over possibly different stones. However, though I agree that the presence of the second indefinite could have an effect on the availability of inverse scope, it does not have any bearing on the main question of this section, namely: are children in principle able to restrict the indefinite to a singleton individual in contexts in which more than one similar individual is available. Furthermore, including another indefinite would complicate the children’s task. Not only do children need to restrict the subject indefinite to an appropriate domain, but they also have to do this for a second indefinite.

Then the dog jumps over the pond. The final cat thinks he can do better and jumps not once, but twice over the pond.

Test statement: *Een kat is twee keer over de vijver gesprongen.*

a cat is two times over the pond jumped
'A cat has jumped over the pond twice'.

A follow up story contained two trials of a control condition in which children were presented with statements of the form: *a/an X V-ed Y*. This condition was included to see whether children had any trouble interpreting the indefinite as referring to one individual out of a similar set of individuals (e.g. the partitive interpretation of the indefinite) when the sentence did not contain any other scope taking expressions. The Singleton Restriction account would lead us to expect non-targetlike performance on this control condition too.⁶⁸

The procedure was the same as the procedure used in the experiments described in previous sections.

3.8.3 Results

The 38 children were highly accurate on the two trials of the control condition (e.g. 95% accurate), suggesting that children have no problems finding a specific referent for the indefinite article in a situation in which multiple possible referents are available. The results for the TWICE-sentences are presented in table 10 below:

situation	N	N true
TWO-CAT	38	7 (18%)
ONE-CAT	38	36 (94.7%)

Table 10: Results TWICE experiment.

As shown in table 10, children nearly always (correctly) rejected the test sentence as a description of a two-cat event (e.g. 82% of the time). Furthermore, almost 95% of the children accepted the test statement in a

⁶⁸ Actually we have quite a strong indication that children do not have problems interpreting this sentence type. Recall that experiment II (e.g. the experiment testing English-speaking children's interpretation of the indefinite determiner *some*) included control items of the type: *Some mouse is wearing a hat*. This type of sentence was presented in situations in which one mouse out of a set of mice was wearing a hat. Children's performance on this control condition was more than 80 percent accurate.

ONE-CAT event. These children thus have no problems arriving at a partitive interpretation of the test sentences when the sentence does not contain a universal quantifier, but rather a frequency adverb. Neither of the two children who judged the test sentence to be false of the ONE-CAT situation was able to explain to the puppet why they thought he was wrong.

3.8.4 Discussion

The results of this experiment show that children do not have problems interpreting the indefinite as “specific” when it interacts with a scope-taking element other than the distributive universal quantifier. Almost all of the children correctly accepted the test sentence as a description of a ONE-CAT event. This suggests that the locus of the Reverse-pattern is not a problem with contextual restriction in the interpretation of indefinites (e.g. the Singleton Restriction Hypothesis).⁶⁹

Furthermore, children reject the test statements almost 82 percent of the time in the TWO-CAT situation, suggesting that these children have acquired the Dutch scope constraint which forces a wide scope interpretation of subject indefinites, contra Krämer (2000).

3.9 General Discussion and Conclusion

This chapter introduced two distinct theories which attempt to explain children’s non-targetlike comprehension of double-object constructions and transitive sentences in which an indefinite interacts with a universal quantifier. Both of these accounts make reference to the indefinite. The Modified Lexical Factor Hypothesis argued that the locus of the non-targetlike performance is incomplete acquisition of the meaning of the indefinite article *a/an*. At an early stage of development children assign non-overlapping meanings to *a/an* and *one*. They take *one* to mean ‘exactly one’ and thus only allow it to refer to sets whose cardinality is ‘one’, but do not allow *a/an* to have the same meaning and thus take it to mean ‘not exactly one’. To judge a test sentence to be true of a ONE>ALL event children need allow *a/an* refer to a set whose cardinality is ‘one’. Since they cannot do this, they judge the test sentence to be false. In the case of ALL>ONE events the indefinite applies to multiple individuals and not just to one, and children are thus able to judge test sentences to be true of this type of event. The

⁶⁹ However, it is important to keep in mind that in this experiment we examined indefinite subjects. What applies to subjects in transitive constructions does not necessarily translate to indirect objects in dative constructions.

Modified Lexical Factor Hypothesis only predicts non-targetlike performance for a single lexical item, namely the indefinite article *a/an*. Children are not expected to show the Reverse-pattern with other indefinites. This prediction was put to the test in this chapter.

The second account, e.g. the Singleton Restriction Hypothesis, did not limit itself to a single lexical item, but to singular indefinites in general. It was based on Schwarzschild (2002)'s theory of singleton indefinites. Schwarzschild argued that all indefinites are contextually restricted. When indefinites are interpreted as "specific", the indefinite is contextually restricted to a singleton individual, rendering it essentially scopeless. The Singleton Restriction Account argued that the problem lies in children's failure to arrive at a source-set interpretation of an indefinite and to restrict the domain of the indefinite to a set containing only a single individual. That is, it argued that children are unable to restrict the reference of an indefinite to a single individual when the context makes salient a set of other individuals which could plausibly be part of the domain restriction of the indefinite. The Singleton Restriction Hypothesis predicted that non-targetlike performance would be observed with all singular indefinites and in all situations in which a source-set interpretation of an indefinite needs to be derived.

In this chapter we have seen that neither account is able to explain the Reverse-pattern. The Modified Lexical Factor Hypothesis predicted the Reverse-pattern to be restricted to test sentences containing the indefinite article. However, the results of experiments II and III have shown that children also show this non-targetlike pattern when the indefinite article is replaced by the singular indefinite determiner *some*, and the numeral *one* (and Dutch *één*), albeit to varying degrees. The Singleton Restriction account predicted non-targetlike performance in all situations in which the indefinite needs to get a source-set interpretation. However, experiment IV has shown that this is not the case. The Reverse-pattern does not seem to be caused by a problem with the interpretation of indefinites. Rather, the other quantified expression (e.g. the universal quantifier) seems to be relevant, as non-targetlike performance was only observed in sentences containing a distributive universal quantifier, and not in sentences containing, for instance, the frequency adverb *twee keer* ('twice').

Chapter 4

Lexical Factors II: The Universal Quantifier

4.1 Introduction

The results of the experiments discussed in the previous chapter show that incomplete acquisition of the (meaning of the) indefinite article does not explain the Reverse-pattern. It was observed that the Reverse-pattern is not limited to double-object constructions in which one of the objects (the indirect object) is headed by the indefinite article *a/an* (contra the Modified Lexical Factor Hypothesis) and that, in fact, children have no problems interpreting indefinite articles as “specific” when the indefinite interacts with a frequency adverb instead of a universal quantifier (contra the Singleton Restriction Hypothesis).

The fact that non-targetlike performance disappears in sentences without a universal quantifier suggests that the Reverse Pattern could be related to children’s interpretation of universal quantification.⁷⁰ A non-adult interpretation of universal quantification has been hypothesized multiple times in order to explain the phenomenon of Exhaustive Pairing (see for instance Philip, 1995 and Geurts, 2003). Recall that when five-year old children are presented with a sentence like *Every farmer is riding a donkey* in a situation in which there are three farmers who are each riding a donkey and there is an extra donkey that does not have a rider, they often judge the sentence to be false. When asked why the sentence is false, children will point to the extra donkey (see section 2.5.3). However, we argued in section 2.5.3 that the Reverse-pattern, or rather children’s rejection of test sentences in ONE>ALL events, is not an instance of Exhaustive Pairing. The Reverse Pattern is observed more often than the Exhaustive Pairing error (at least in the Dutch experiments), it persists longer and elicits different responses when children are asked to explain their judgments.⁷¹ In this chapter we will therefore pay little attention to theories proposed for Exhaustive Pairing.

⁷⁰ Of course a logical option is that the Reverse Pattern in fact results from interaction between two factors, namely *a/an* and \forall . However, in this study we have chosen to first evaluate the factors in isolation before looking at possible interaction effects. We will come back to this in chapter 6.

⁷¹ Later on in this chapter we will come across another (stronger) argument against equating the two phenomena, namely that whereas Exhaustive Pairing occurs with all universal quantifiers (including *all*), the Reverse-pattern does not.

Instead, this chapter attempts to find out when exactly the Reverse Pattern is observed. In particular, it investigates whether it is indeed limited to universal quantifiers, or even to a set of specific universal quantifiers. Furthermore, this chapter will investigate the plausibility of an account based on the distributivity features which form part of the lexical meaning of certain universal quantifiers. The general idea is that children show the Reverse-pattern because they perceive a mismatch between the distributivity forced by the distributivity features of certain universal quantifiers and the properties of the events in which they are presented. However, before we will turn to this account, we will first examine the properties of universal quantification more closely.

4.2 Relating the Reverse-pattern to Universal Quantification

4.2.1 Properties of Universal Quantification

English has three universal quantifiers: *all*, *every* and *each*. Traditionally the negative polarity item *any* has also been considered a universal quantifier (Vendler, 1967; among others). However, we will follow Kadmon and Landman (1993) and assume that *any* is in fact an indefinite. Dutch also has three universal quantifiers: *alle* ('all'), *elk* ('each/every') and *ieder* ('each/every'). In predicate logic (and in more advanced logical languages) all universal quantifiers are treated as equivalent. Sentences (1a) and (1b) are both rendered as (1c). However, this ignores the differences that exist within the class of universal quantifiers.

- (1) a. Every boy is carrying a piano (to the second floor)
 b. All boys are carrying a piano (to the second floor).
 c. $\forall x (\text{Boy}(x) \rightarrow \exists y (\text{Piano}(y) \ \& \ \text{Carry}(x,y)))$

First of all, there is a morphological difference between quantifiers like *each* and *every* on the one hand and a quantifier like *all* on the other (see 2a-d). Whereas *every*, *each* and Dutch *elk* and *ieder* combine with singular (count) nouns, *all* and Dutch *alle* combine with plural nouns.^{72, 73}

⁷² In Dutch there is a further morphological difference in that the gender of head noun of the noun phrase in the complement of the universal quantifiers *elk* and *ieder* determines the exact form of the universal quantifier. When the head noun is non-neuter (for instance the noun *jongen* (boy)) the affix -e is added, so the correct forms would be *elke jongen*, *iedere jongen*. When the head noun of the NP is neuter (like for instance *paard* (horse)) the affix is phonologically null (*elk paard*, *ieder paard*).

- (2) a. *Alle jongens eten taart.*
all boy-PL eat cake
b. All boys eat pie.
c. *Elke/iedere jongen eet taart.*
each/every boy eats cake
d. Each/every boy eats pie.

Another difference is that English *all* and Dutch *alle* can co-occur with another determiner (like a plural definite article or demonstrative), whereas this is not possible with other universal quantifiers (see (3)).

- (3) a. *Al de/die jongens eten taart.*
all the/those boys eat cake
b. All the/those boys eat pie.
c. **Elke/iedere de/die jongen eet taart.*
each/every the/that boy eats cake
d. **Each/every the/that boy eats pie.*

However, most of the quantifiers can occur in a full partitive structure, with the exception of English *every* and Dutch *alle* (see (4)).

- (4) a. All/each/*every of the boys.
b. *Ieder/elk/*alle van de jongens.*
each/every/ all of the boys

Furthermore, there are syntactic differences between the quantifiers, pertaining to the positions in which they can occur, and the types of predicates they can combine with. Consider, for instance, the sentences in (5). Whereas English *all* and *each* can occur in a floated position to the right of the noun phrase that forms their restriction, *every* cannot. *Each* can even occur in sentence final position (see 5c). Furthermore, as (7) shows, only *all* is compatible with collective predicate like *to form a line*.⁷⁴ For Dutch the pattern is slightly different. Both *elk* and *ieder* can in principle occur in a

Alle on the other hand always combines with a plural NP and thus the grammatical gender of the head noun of that NP does not affect the form *alle* takes: *alle jongens*, *alle paarden*.

⁷³ Collective universal quantifiers *all* and *alle* can also combine with mass nouns (*all furniture*, *all rice*), though in Dutch the addition of a definite article is sometimes required: *??alle geld* ('all money'), OK *al het geld* ('all the money').

⁷⁴ A collective predicate is a predicate which requires the NP it is predicated of to be plural.

floated position (see (7)). However, this is most acceptable in the case of *elk*. *Alle* cannot occur in a floated position on its own.⁷⁵ It can only occur in such a position as part of the more complex quantifier *allemaal*, which roughly translates as all-whole (see 6b). Like in English, only a DP headed by *alle* can combine with a collective predicate like *een rij vormen* ('form a line'), see (8).

- (5) a. The boys **all** ate an apple.
 b. The boys **each** ate an apple
 c. The boys ate an apple **each**.
 c. *The boys **every** ate an apple.
- (6) a. ??*De jongens aten allen een appel.*
 the boys ate all an apple
 b. *De jongens aten allemaal een appel.*
 the boys ate all-whole an apple
 c. *De jongens aten elk een appel.*
 the boys ate each/every an apple
 d. *De jongens aten ieder een appel.*
 the boys ate each/every an apple
- (7) a. All students formed a line.
 b. *Every student formed a line.
 c. *Each student formed a line.
- (8) a. *Alle jongens vormden een rij.*
 all boys formed a line
 b. **Elke/iedere jongen vormde een rij.*
 each/every boy formed a line

Another difference between *all* on the one hand, and *each*, *every* on the other, relates to the ease with which these quantifiers can take wide scope over another quantifier. In (9a) both *every* and *each* can take wide scope over the subject, and thus the sentence can mean that for every/each athlete there is a (possibly different) doctor that examined him. However, in sentence (9b) the interpretation where for all individual athletes there is a different doctor that examined the athlete (e.g. a distributive interpretation) is strongly dispreferred. This fact has led some researchers to hypothesize

⁷⁵ Though for the author sentence (6a) is unacceptable, intuitions concerning the acceptability of this construction seem to vary between speakers.

that *all* is not a true quantifier or rather does not have quantificational force of its own (see for instance Brisson, 1998). These researchers hypothesize that for a quantifier like *all* to take wide scope, it needs to combine with a separate (covert) distributivity operator (a D-operator).

- (9) a. A doctor examined every/each athlete
(every/each>>a).
b. A doctor examined all the athletes (??all>> a).

For Dutch the intuitions concerning the availability of wide scope of universal quantifiers are less clear, as inverse scope of the universal quantifier is less available in Dutch than it is in English. A wide scope interpretation of the indefinite in the subject is highly preferred. However, even in Dutch a distributive interpretation of (10a) is more acceptable than a distributive interpretation of (10b).

- (10) a. *Een arts onderzocht elke/iedere atleet.*
a doctor examined each/every athlete
(?elke/iedere>> een)
b. *Een arts onderzocht alle atleten.*
a doctor examined all athletes
(?*/* alle>>een)

In sum, there are many differences within the class of universal quantifiers, particularly between *all* and *alle* on the one hand, and *each*, *every*, *elk* and *ieder* on the other. Most of the differences discussed in this section are morphological or syntactic(o-semantic) in nature, though we did discuss the interpretational consequences of these features. In this section we have already hinted at the fact that quantifiers like *each* and *every* differ from *all* with regard to the ease with which a distributive interpretation is available. The next section will investigate the interpretative differences further, and will specifically focus on the distinction between distributive and collective universal quantification.

4.2.2 Distributive vs. Collective Universal Quantification

In this section we will focus on semantic differences between the universal quantifier *all* (or Dutch *alle*) on the one hand, and quantifiers like

every and *each* (or Dutch *elk*, *ieder*) on the other hand.⁷⁶ Consider the sentences in (11) containing the predicate *to lift (a piano)*:⁷⁷

- (11) a. All (the) men are carrying a piano upstairs.
 b. *Alle mannen tillen een piano naar boven*
 all men lift a piano to above
 ‘All men are carrying a piano upstairs’.
 c. Every/each man is carrying a piano upstairs.
 d. *Elke/iedere man tilt een piano naar boven*
 each/every man carries a piano to above
 ‘Each/every man is carrying a piano upstairs’.

All of these sentences are felicitous descriptions of an (unlikely) situation in which there are multiple men who are each (on their own) carrying a piano upstairs, e.g. an event comparable to the ALL>ONE events in the experiments presented in previous chapters. I will refer to an event like this, in which for every individual in the restriction set of the universal quantifier there is a distinct event in which the property described by the sentence holds for that individual, as a PROTOTYPICALLY DISTRIBUTIVE EVENT.

However, when all of the men are involved in a single action of carrying a piano upstairs, not all sentences are equally acceptable. We will distinguish two event-types: a COLLECTIVE-ACTION EVENT and a COLLECTIVE-RESPONSIBILITY EVENT.⁷⁸ In the case of a collective action event all individual men have the property of carrying the piano. They just are not carrying the piano by themselves. The English sentence in (11a) and the Dutch sentence in (11b) are felicitous in this event type. English *each* seems to be unacceptable in such a situation. *Every* and both Dutch *ieder* and *elk* can be (marginally) acceptable in such a situation.⁷⁹ In principle when all of the men are carrying a piano upstairs, each individual man has the

⁷⁶ For the purpose of this exposition we will ignore the differences between the English universal quantifiers *each* and *every*. For more information about this see Tunstall (1998). Incidentally, the two Dutch quantifiers (*elk* and *ieder*) seem to be near synonyms.

⁷⁷ The predicate *to lift* is an ‘ambiguous’ predicate. That is, it is compatible with distributive events, collective events and everything in between. In this it differs from collective predicates like *form a line* and distributive predicates like *to sleep*.

⁷⁸ For more information about the distinction between distributive and collective events, see Dowty (1986), Kennelly (2004), Landman (1989, 1996), Lasersohn (1988), Scha (1981), and Verkuyl (1994). The terms collective action-event and collective responsibility event are taken from Landman (1996).

⁷⁹ See Van der Ziel (2008).

property of carrying a piano; it is just not an entire piano per person. However, for this event-type a group interpretation is more easily derived than a distributive interpretation, given that the men are lifting a piano together. Therefore, in such situations *all* (or Dutch *alle*) is perceived to be much more acceptable. In a collective responsibility event the group of men has the property of carrying a piano upstairs, but not all men are actually lifting the piano. One of them may be opening a door at the top of the landing or holding a light. Only (11a) and (11b) can felicitously describe such a situation. The other sentences are false in this situation type.

	prototypical distributive	collective-action	collective responsibility
each	√	*	*
every	√	(√)	*
all	√	√	√
elk ('each/every')	√	(√)	*
ieder ('each/every')	√	(√)	*
alle ('all')	√	√	√

Table 1: Possible Interpretations per Quantifier

To summarize, *each* and *every* (and Dutch *ieder* and *elk*) are only felicitous in situations which can be interpreted as distributive (e.g. the prototypical distributive event and to some extent a collective action event). That is, they require the property that holds for the entire set to also hold for every individual member of the set. *All*, however, is also felicitous in collective situations (or group events). Sentence (11b) does not require every individual boy to be carrying the piano. Rather, it requires that this property holds for the group of boys (collectively). The sentence is thus true when all of the boys are involved in a separate action of piano-carrying (a prototypical distributive event), when all of the boys are involved in a single action of piano carrying (a collective-action event), or even when not every single boy is actually involved in the action of carrying the piano but all are working towards this goal (a collective-responsibility event). This difference in interpretation constitutes one crucial difference (and probably the main semantic difference) between quantifiers like *all* and quantifiers like *every*.

Following Landman (1996), I will assume that distributive universal quantifiers quantify over sets of pluralities (e.g. plural predication), while a quantifier like *all* can also quantify over plural individuals (e.g. singular predication). Thus, a quantifier like *every* quantifies over a set of singular individuals made into a plurality by virtue of some plurality operator (Link, 1983: the *-operator) which creates sum individuals. *All*, on the other hand, does not necessarily apply to the individuals that make up a plurality, but can

also quantify over a whole plurality as an individual. In this case *all* gets a group interpretation. It is this property of *all* and *alle* which ensures that they are consistent with collective-responsibility events.

In short, the main difference between a quantifier like *every* and a quantifier like *all* is that the former requires a distributive interpretation (and thus plural predication), while the latter does not. In the next section one hypothesis which capitalizes on the fact that certain universal quantifiers lexically encode distributivity will be discussed, namely the Distributivity Hypothesis. This hypothesis is inspired by Drozd and Van Loosbroek (2006)'s account of Exhaustive Pairing, though it also differs from it in some important respects.

4.2.3 The Distributivity Hypothesis

In this section a new hypothesis to explain the Reverse Pattern will be formulated, namely the Distributivity Hypothesis. This hypothesis is in many ways indebted to an earlier distributivity hypothesis proposed in Drozd and Van Loosbroek (2006), which was in turn an addition to Drozd's (2001) Presuppositionality Account of Exhaustive Pairing. Therefore, this section will start off describing Drozd's (2001) account, and follow this with a description of Drozd and Van Loosbroek's modification. We will then show that the Distributivity Hypothesis proposed by Drozd and Van Loosbroek does not actually explain the facts it was designed to explain. However, we will use some of its characteristics to formulate our own Distributivity Hypothesis.

Universal quantifiers come with certain (lexical) presuppositions.⁸⁰ One of these presuppositions is that the domain of the quantifier is non-empty and that there should thus be individuals in discourse which can form the domain of the universal quantifier (see for instance Szabolcsi, 1997). A sentence like *Every man is eating an apple* presupposes that in the discourse context there is a set of men who can form the domain of the universal quantifier. In order to verify the sentence one compares that contextually available set of men with the set of apple-eating men and determines whether the two sets are identical.

⁸⁰ Not all presuppositions are lexical, some are 'implicated'. An example of the latter type would be the anti-duality presupposition which applies to universal quantifiers like *every* (but not *each*). This presupposition requires the domain of a universal quantifier to contain more than two elements (Sauerland, 2008), thus explaining why a sentence like *Philippe broke every arm* is unacceptable, while a sentence like *Philippe broke each arm* is.

However, what if a language user fails to derive the domain presuppositions of universal quantifiers? According to Drozd (2001), this is what happens when children make the Exhaustive Pairing error. Recall from previous chapters that exhaustive pairing is the phenomenon where children reject simple quantified statements like *Every farmer is riding a donkey* in situations in which it is the case that every single farmer is riding a donkey, but there is also a donkey who is riderless. According to Drozd (2001), Exhaustive Pairing can be explained in terms of a failure to recover implicit domain presuppositions associated with universal quantifiers. To interpret a sentence like (12) in a target-like way, children need to analyze both the (presupposed) set of farmers and the set of donkey-riders, and then compare the two sets to see whether every element of the set of farmers is also an element of the set of donkey-riders.

(12) Every farmer is riding a donkey

However, Drozd hypothesized that children may fail to have a presupposed set in mind, and thus do not compare the set of donkey-riders to the set of farmers in the context, but rather “with what they consider to be the normal or expected frequency of [donkey-riding farmers] in that context” (Drozd and Van Loosbroek (2006):120). When children are presented with the Extra-Object situations in which Exhaustive Pairing is observed, they may expect there to be a farmer for each of the donkeys. However, in the actual experimental context this is not the case, as there are only three farmers riding a donkey and there is no farmer for the fourth donkey. This mismatch between the set of farmers children expect to see and the set of farmers in the experimental situation causes children to reject the test statement and thus make the Exhaustive Pairing error.

In a sense children who display Exhaustive Pairing do not interpret the universal quantifier as a strong (presuppositional) quantifier but rather as if it was a weak (non-presuppositional) quantifier. Consider sentence (13) containing the weak quantifier *many*.

(13) Many_C Scandinavians have won the Nobel Prize in literature.

On its weak construal, the so-called Westerståhl-sentence in (13) is interpreted by comparing the number of Scandinavians that have won the Nobel Prize in literature with the expected frequency of Nobel Prize-winners, and not with the set containing all Scandinavians (Westerståhl, 1985, 1989). Sentence (13) can thus have a context-dependent interpretation. Drozd argues that children interpret the universal quantifier in a sentence

like (12) as if it were a weak non-presuppositional quantifier which gets a context-dependent interpretation.⁸¹

However, according to Drozd and Van Loosbroek (2006) a failure to analyze domain presuppositions is not the only way in which children's interpretation of universal quantification may differ from the adult-like interpretation. That is: "a child may not always analyze universal quantifiers as presuppositional in contexts in which the presuppositional interpretation is not unambiguously supported [...] We hypothesize that children may also not always recover the distributive interpretation of *every* in similar contexts" (Drozd and Van Loosbroek, 2006: 121). In other words, children may not only fail to derive lexical domain presuppositions of universal quantifiers, but may also fail to derive some other aspects of the lexical meaning of certain universal quantifiers, like the inherent distributivity of quantifiers like *each* and *every*. If this is the case, then children should experience (additional) problems interpreting distributive universal quantifiers (like Dutch *elk* and *ieder*) in contexts in which the distributivity of the quantifiers is not unambiguously supported, while they should not experience these problems when interpreting non-obligatorily distributive universal quantifiers (like *alle*) in the same contexts. Drozd and Van Loosbroek tested this prediction by presenting Dutch-speaking preschool children with sentences like (14) in a situation in which three boys are riding the same elephant and two elephants are riderless. They found a significant contrast between (14a) and (14b) for the four-year olds (though not for the five-year olds). That is, the performance of the four-year old children was more accurate on sentences containing *alle* than it was on sentences containing *ieder(e)*. The prediction was thus partly borne out.

- (14) a. *Rijdt iedere jongen op een olifant?*
rides every boy on an elephant
'Does every boy ride an elephant?'
- b. *Rijden alle jongens op een olifant?*
ride all boys on an elephant
Do all the boys ride an elephant?'

However, note that failing to recover domain presuppositions is fundamentally different from failing to recover distributivity features. In the former case it is assumed that when children fail to derive the domain presuppositions, they end up interpreting a strong quantifier as if they were

⁸¹ See Smits (2010) for a detailed investigation into the role of context on quantifier interpretation.

weak or rather context-dependent. However, it is not at all straightforward to determine what it means for a child to fail to derive the distributivity of a universal quantifier. According to Drozd and Van Loosbroek, the main distinction between *every*, and *each* on the one hand, and *all* on the other hand, is the fact that distributivity is lexically encoded for the former, but not for the latter (see section 4.2.2 for evidence). If children failed to recover the distributivity of *every*, they would thus end up with a quantifier which is similar to a universal quantifier like *all*. That is, they would end up with a universal quantifier that does not impose any strong restrictions on the situations it describes and is thus consistent with a large number of situations and event structures, including collective and distributive situations (see table 1 above). This would imply that children should show the same performance pattern when they are presented with sentences containing *ieder(e)* and *alle*, and thus that children's performance on sentences like (14a) and (14b) should not differ. In other words, though at first sight this Drozd and Van Loosbroek's Distributivity Hypothesis seems to predict a distinction between distributive universal quantifiers and other universal quantifiers, a close examination of the proposal shows that in its current form for the hypothesis does not actually predict any contrast between *ieder* and *alle*.

As we have shown above, the Distributivity Hypothesis as proposed in Drozd and Van Loosbroek (2006) fails to explain the difference it was designed to explain. However, we will adopt some of Drozd and Van Loosbroek's basic ideas in order to formulate a new Distributivity Hypothesis. That is, we will capitalize on the distributivity features that are lexically encoded for certain universal quantifiers and which force a distributive interpretation. Furthermore, we will adopt the assumption that children may fail to interpret a situation as distributive when this distributivity is not unambiguously represented. According to the new Distributivity Hypothesis children judge test sentences to be false of ONE>ALL events because of a MISMATCH between the distributivity features of the universal quantifier and their perceived interpretation of the event. In other words, five-year old children know that universal quantifiers are distributive and they know that this means that the contexts in which they are used need to be interpretable as distributive. However, when the context does not unambiguously have this property, children fail to consider the contexts distributive and hence reject the test sentences.

An issue that needs to be discussed is when a situation unambiguously supports distributivity, and when it does not. Generally a situation satisfies distributivity when the property that holds for all elements in the domain also holds for every individual element in the domain. A distributive universal quantifier requires one to check whether for every

single element in the domain a certain property holds.⁸² We will assume that for a sentence like (14a) an unambiguously distributive situation would be a situation in which every boy is riding his own elephant, as in this situation it is immediately clear that the property of riding an elephant holds for each individual boy. This situation would correspond to an ALL>ONE event. When it is the case that each boy is riding an elephant but there is no one-to-one correspondence between elephants and boys, it is rather more difficult to check whether the situation really satisfies the property of distributivity. It is not sufficient anymore to check boy-elephant pairs, but children instead have to check for each boy individually whether he indeed has the property of riding an elephant. We will assume that when a context does not allow children to immediately determine that the distributivity-features of a certain quantifier are satisfied, children assume that the context does not match the test sentence.

Let us now see examine how this Distributivity Hypothesis would explain the Reverse Pattern. Let us first consider the ONE>ALL event described below:

ONE>ALL Event:

This story is about a bear who is celebrating his birthday. He has invited all of his friends. Three foxes and a mouse attend the party. The bear offers his friends some cake. The first fox declines because he does not like cake. The second fox states that he is not hungry. The mouse declines because he thinks the pieces of cake are too big. The third fox is very hungry and claims to be able to eat all of the pieces of cake. The bear subsequently gives him all three pieces of cake.

The test sentence to go with this context was: *The bear gave a fox every piece of cake*. Note that in this context all of the objects in the restrictor set of the universal quantifier (e.g. the pieces of cake) are given to a fox in one *giving*-event. It is not the case that there are separate events of giving a piece of cake to a fox (which happens to be the same fox). In a sense this event is similar to a collective-action event (see section 4.2.2). In such an event the property of distributivity holds for the objects in the domain of the quantifier, but not all of these objects are associated with distinct events of *giving-it-to-a-fox*. Furthermore, in the pictures associated with the ONE>ALL event the cakes are not obviously individuated. They are

⁸² In chapter 5 we will refine this notion of distributivity through the addition of event structure.

presented on a single plate and partly overlap (see picture 1 below) and could thus be interpreted as a group. The fact that the ONE>ALL event does not encode one-to-one distributivity, coupled with the fact that the set of pieces of cakes is more easily interpreted as a group or collection than as a number of individual pieces of cake ensure that this context is not unambiguously distributive. When children are presented with the test sentence and encounter the universal quantifier they check whether the ONE>ALL event is distributive. However, when they do not immediately recognize its distributivity they conclude that there must be a mismatch between the event and the test sentence. This mismatch causes children to reject test sentences in ONE>ALL events.

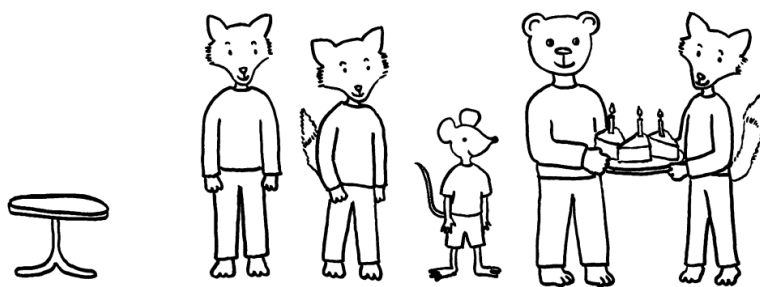

Picture 1: Final Picture ONE>ALL event.

Test sentence: *The bear gave a fox every cake.*

ALL>ONE events do have an explicit one-to-one mapping of cakes to foxes (that is, every piece of cake would be given to a different fox). Children should thus have no problems interpreting this event-type as distributive. If children are not constrained by the Frozen Scope Constraint they are expected to judge test sentences to be true for this event-type.

The revised Distributivity Hypothesis predicts that children's non-target-like performance on sentences containing quantification is limited to sentences containing obligatorily distributive quantifiers, as only these quantifiers require children to interpret the events in the experimental contexts distributively. This implies that children should perform

significantly more target-like when presented with the universal quantifier *alle*, or a cardinal quantifier like *three*. While these two quantifiers can be interpreted distributively they do not (lexically) require a distributive interpretation. This prediction is examined in the next few sections.

4.3 Experiment V: Testing DRIE

In chapter 3 children were presented with sentences like *the bear gave a fox every cake* as well as sentences in which it was not a universal quantifier but rather another quantified expression that interacted with an indefinite, e.g. *Een kat is twee keer over het hek gesprongen* (Lit: A cat is twice over the fence jumped). The results showed that children performed target-like on the latter sentence type. However, those sentences were not directly comparable to the test sentences used in previous experiments. For one, the test sentence was not a double-object construction, but rather a transitive sentence in which the indefinite occurred in subject position. Consequently, the context in which the test sentence was presented was also not comparable to the contexts used in previous experiments. Therefore, before focusing on the role of universal quantification and distributivity, it is necessary to establish that the Reverse-pattern is really not observed in sentences in which a quantified expression other than a universal quantifier interacts with the indefinite.

A suitable quantified expression is the cardinal quantifier *drie* ('three'). Following standard diagnostics (Milsark, 1977), this cardinal quantifier can be taken as a weak quantifier. However, this quantifier shares certain characteristics with universal quantifiers, in particular with the quantifier *all*. That is, it can be used to describe a distributive situation, but does not force a distributive interpretation of the context it is presented in. The sentence *Three men carried a piano upstairs* is a true description of a situation in which three men each carried a piano upstairs, as well as a situation in which they carried the piano upstairs together.⁸³ Furthermore, there is some evidence that the Reverse-pattern may also occur with double object constructions containing the numeral *three*, like *The father gave a girl three balloons* (e.g. Bergsma-Klein (1996), referenced in Krämer (2000)).

In the experiment we conducted children are presented with sentences like:

⁸³ In addition, the sentence is also consistent with a collective-responsibility event in which all three men were involved in carrying the piano upstairs, but not all of them were actually carrying it.

- (15) The bear gave a fox three pieces of cake.

For adults the only licit interpretation of this sentence is the interpretation where a single fox is given three pieces of cake. The sentence is not a truthful description of a situation in which the three pieces of cake are each given to a different fox, although it is unclear whether this is because of Scope Freezing, or because of a strong tendency to interpret the three pieces of cake as a group of (non-individuated) objects whose cardinality is three.

4.3.1 Participants

Eight monolingual Dutch-speaking preschool children (five girls and three boys) were tested on double-object constructions with the numeral *drie* ('three') heading the direct object. They were between 5;0 and 6;4 years old (mean age 5;10) and were drawn from a single preschool in the Utrecht-area of the Netherlands. A group of five adult controls (all non-linguists) was tested on the same materials. The controls were between 19 and 30 years old (mean age 25). This group consisted of one man and four women.

4.3.2 Design and Procedure

The test sentences were double-object constructions in which the direct object either contained the cardinal quantifier *drie* ('three') or the distributive universal quantifier *ieder* ('each/every'), as in (16).

- (16) a. *De beer heeft een vos drie stukken taart gegeven.*
 the bear has a fox three pieces (of) cake given
 'The bear gave a fox three pieces of cake'.
 b. *De beer heeft een vos ieder stuk taart gegeven.*
 the bear has a fox every piece (of) cake given
 'The bear gave a fox every piece of cake'.

Note that one further difference between (16a) and (16b) is the fact that when the numeral *drie* is used the following NP is pluralized, while the universal quantifier *ieder* takes a singular NP complement. This should not affect the results, but it is important to keep this in mind nonetheless.

As in all other experiments, the test sentences were presented in two types of events: ONE>ALL events and ALL>ONE events. Recall that a ONE>ALL event is an event in which one of the individuals ends up with all of the objects, so, for example, a single fox would be given all of the pieces of cake by a bear. In an ALL>ONE event, the pieces of cake would be equally distributed over the foxes. Sentence (16b) is a true description a

ONE>ALL event, but a false description of an ALL>ONE event. Sentence (16a) can also truthfully describe a ONE>ALL event, since a single fox is given cakes, and the cardinality of the set of cakes that is given is three. This sentence is false in an ALL>ONE event. In total there were thus four distinct conditions: DRIE ONE>ALL, DRIE ALL>ONE, IEDER ONE>ALL and IEDER ALL>ONE.

Children were presented with four test stories (the same stories as used in the experiment on the numeral *some* described in chapter 3, see appendix 3). Each child was presented with three instances of the two conditions testing DRIE, and one instance of the conditions testing IEDER. For most of the children the IEDER-conditions were presented last. However, in order to check for possible carry-over effects, three of the children were presented with a version of the experiment in which the IEDER-conditions came first.

4.3.3 Results

The results of this experiment show that children have no problems interpreting sentences like (16a). None of the children showed the Reverse-pattern. In fact, when presented with ONE>ALL events all of the children accepted the test statements. When presented with ALL>ONE events all but two of the children rejected all the test statements. The other two accepted one of the test statements and rejected the other two. In other words, the children perform target-like on the conditions containing DRIE.

When presented with the IEDER-sentences these children perform relatively well. While in previous experiments children rejected double-object constructions containing a distributive universal quantifier (the quantifier *elk*) about 68% of the time in ONE>ALL events, in this experiment 6 out of 8 children accept the test sentences in ONE>ALL events. Furthermore, in previous experiments about 75 percent of the children accepted test statements in ALL>ONE events. However, in this experiment only 2 of the 8 children accepted a sentence like (16b) in such an event. Two children showed the Reverse-pattern on the IEDER-conditions. Further analysis showed that the Reverse-pattern was only observed in children who were presented with a version of the experiment in which the IEDER-conditions preceded the DRIE-conditions, suggesting the possibility of a strong carry-over effect.

The adult control group always rejected test sentences in ALL>ONE events, and always accepted them for ONE>ALL events.

One caveat is that the sample size of this experiment is relatively small. One could argue that it is too small to base any conclusions on. This is

a valid point, but given the consistency of children's judgments I would argue that the results in fact do hold up.

4.3.4 Discussion

The results (in section 4.3.3) show that when children are confronted with sentences like (16a) they almost invariably perform target-like. That is, they reject test statements as descriptions of ALL>ONE events and accept them as descriptions of ONE>ALL events. Children still show the Reverse-pattern when presented with the IEDER-conditions, but only when the IEDER-conditions are the first conditions they see. There thus seem to be carry-over effects at work here. Children's judgments on the DRIE-conditions influence their judgments on the IEDER-conditions. This could suggest that when interpreting a sentence containing a cardinal quantifier children choose a different interpretation strategy than when they are interpreting a distributive universal quantifier, an interpretation strategy which seems to be biased towards a "collective" interpretation. This interpretation strategy is then "carried over" to sentences containing the distributive universal quantifier. When the IEDER-conditions are presented first, children choose another strategy. However, they do not seem to stick with this strategy when interpreting subsequent DRIE-trials.

In sum, this experiment provides support for the hypothesis that the Reverse-pattern is limited to universal quantifiers.

4.4 Experiment VI: Testing ALLE

In the previous section we have seen that children do not show the Reverse-pattern when they are presented with test sentences containing the cardinal quantifier *drie* ('three'). In this experiment, we will test children's interpretations of double-object constructions containing the universal quantifier *alle*.

The Distributivity hypothesis put forward in section 4.2.3 claims that when a context does not unambiguously support the distributive interpretation that certain universal quantifiers (lexically) require (which is the case in ONE>ALL events), children reject test sentences containing such quantifiers. One prediction of this hypothesis is that children's non-target-like performance should be restricted to sentences containing quantifiers which are obligatorily interpreted distributively, and should not be observed with sentences containing the (collective) universal quantifier *alle*.

These predictions are put to the test in the experiment described in this section. Children were presented with sentences (double-object constructions) containing the universal quantifier *alle*, as well as control

sentences containing a distributive universal quantifier. In both cases children who perform target-like should accept the test sentences in ONE>ALL events, as the interpretation where the indefinite in the indirect object takes wide scope over the universal quantifier should be the only licit interpretation of the test sentence. Furthermore, they should reject ALL>ONE events. The distributive interpretation derived through inverse scope of the universal quantifier over the indefinite should be disallowed, as Scope Freezing should apply here.⁸⁴

4.4.1 Participants

30 Dutch-speaking preschool children (13 boys and 17 girls) were presented with the experimental materials.⁸⁵ They were between 4;0 and 6;7 years old (mean age 5;5). The children were tested at a primary school in the Utrecht area. Six Dutch-speaking adults (non-linguists) were included as a control group. The ages of the controls ranged between 25 and 59 (mean age 36).

4.4.2 Design and Procedure

The experiment contained multiple stories testing sentences like (17a) containing the universal quantifier *alle*, and sentences like (17b) containing the distributive universal quantifier *ieder* ('every').

- (17) a. DO-ALLE:
De beer heeft een vos alle stukken taart gegeven
 the bear has a fox all pieces (of) cake given
 'The bear gave a fox all pieces of cake'.
 b. DO-IEDER:
De beer heeft een vos ieder stuk taart gegeven
 the bear has a fox every piece (of) cake given
 'The bear gave a fox every piece of cake'.

Each type of test sentence was presented in two types of events, e.g. ONE>ALL and ALL>ONE events. Recall that ONE>ALL events are events in which a single individual ends up with all the objects. ALL>ONE events are events in which the objects are distributed evenly over a set of individuals (exhausting both sets). Children were thus presented with four

⁸⁴ However, as discussed in section 4.2.1 above, in the case of *alle* inverse scope is generally dispreferred.

⁸⁵ Four of the children were bilingual; they spoke Turkish or Arabic at home.

distinct test conditions: ALLE ONE>ALL, ALLE ALL>ONE, IEDER ONE>ALL, IEDER ALL>ONE.

To check whether children were able to interpret statements containing a single universal quantifier correctly (and thus had at least basic knowledge of universal quantification), children also judged a variety of control statements of the form *Every X V-ed Y* (Q-controls). Finally, statements that were saliently true or false in the context were included as attention controls.

In total children saw four test stories (the same test stories as in the experiment on *drie* ('three') and the experiments discussed in chapter 3). The ordering of the stories was counterbalanced across participants. In the previous experiment, we observed a strong carry-over effect between the quantifiers *drie* and *ieder*. In this experiment we were mainly interested in children's performance on *alle*. Therefore, the test items containing *ieder* were always presented in the last story, thereby preventing carry-over from *ieder* to *alle*.

4.4.3 Results

4.4.3.1 Group Results

The following table presents the mean percentages of true and false judgments for the four conditions tested in this experiment:

sentence type	event	children (N=30)	adults (N=8)
		%true	%true
DO-ALLE	ONE>ALL	94.2	100
	ALL>ONE	56.3	0
DO-IEDER	ONE>ALL	58.6	50
	ALL>ONE	79.3	0

Table 2: Mean percentages per condition

While the participating children nearly always judged ALLE-sentences to be true in ONE>ALL events (94.2% of the time), they did so significantly less often when presented with IEDER-sentences in the same event-type (58.6% of the time). A Wilcoxon test (with Bonferroni correction) revealed a highly significant difference between the two conditions ($Z = -3.18$, $p \leq .001$).

Children judged sentences with IEDER to be true of ALL>ONE events approximately 79% of the time. They did this less often when presented with ALLE-sentences (56%). The difference between the two conditions is significant (Wilcoxon test: $Z = -2.69$, $p \leq .007$, also significant after a Bonferroni correction).

To see whether there was an effect of age, the children were divided into three age groups: the 4-year olds (N=7), the 5-year olds (N=14) and the 6-year olds (N=9). A Kruskal-Wallis test revealed a significant effect of age on the IEDER-ONE>ALL condition ($p \leq .043$). None of the other conditions revealed any significant difference ($p \leq .108$). A closer examination of the results revealed that all 4-year olds consistently judged the IEDER-ONE>ALL condition to be true. We will get back to this result in section 4.5.

It was further observed that one test story, the Zoo-story, elicited a significantly larger amount of ‘yes’-responses on the ALL>ONE event than any of the other stories. The Zoo-story is a story about a girl who is feeding animals at the zoo. The ALL>ONE event in this story is an event in which she feeds each of three giraffes an apple (exhausting the set of apples). At this point it is unclear what causes this.

Most adult participants performed target-like on test sentences containing the (collective) universal quantifier *alle*. The controls always rejected double-object constructions containing the distributive universal quantifier *ieder* as descriptions of ALL>ONE events. Their performance on ONE>ALL events was more variable, as half of the controls rejected the test sentences as a description of a situation which conformed to this event type. Two of the adults commented that they did not think the sentence was grammatical. Note, however, that in the experiment testing *drie* none of the participants had any problems with this sentence type. It could be that adults consider sentences with *alle* to be a more optimal way of describing a ONE>ALL event. When after three instances of a sentence with *alle*, they are presented with a similar sentence with *ieder*, they reject the latter because they consider this to be a less optimal way of expressing what happens. The performance of the adults on the test sentences containing a distributive universal quantifier are thus partially an ordering effect.

4.4.3.2 Individual Results

As in the previous experiment, children were grouped according to their individual response patterns. Recall that children showing the Reverse-pattern reject test sentences for ONE>ALL events and accept them for ALL>ONE events. Children showing the Ambiguity-pattern accept test sentence for both events. Children who perform target-like accept test sentences for ONE>ALL events and reject them for ALL>ONE events.

Pattern	ALLE (N)	ALLE (%)	IEDER (N)	IEDER(%)
Reverse	1	3.3	11	36.7
Ambiguity	14	46.7	13	43.3
Target-like	12	40	5	16.7
Unclear ⁸⁶	3	10	1	3.3

Table 3: Individual response patterns

As can be gleaned from table 3, many children exhibited the Reverse-pattern when presented with test sentences containing IEDER, while only one child showed this performance pattern with ALLE-sentences. However, the incidence of the Reverse-pattern on the IEDER-conditions is lower than the percentage reported in previous experiments. One possible explanation for this fact is that children's performance on the IEDER-conditions is influenced by their performance on the ALLE-conditions, in the same way as the performance on the IEDER-trials in the previous experiment was influenced by the DRIE-trials (and the way for adults the ALLE-trials seemed to affect their interpretation of the IEDER-conditions). The IEDER-conditions were always presented after the ALLE-conditions. In other words, there could be a carry-over effect.

Many children, both with ALLE-sentences and with IEDER-sentences, judged both test sentences to be true. For the IEDER-sentences this group included the seven 4-year olds who were briefly mentioned in section 4.4.4.1. Almost 40% of the children performed target-like on the ALLE-sentences. In contrast, only 16.7% performed this way on the IEDER-sentences.

Finally, table 4 shows how children's performance on the ALLE and the IEDER trials relates to each other. Children never performed 'better' on IEDER than they did on ALLE. No child performed non-target like on ALLE but target-like on IEDER.

⁸⁶ One of the children in the Unclear-group consistently judged all test sentences to be false. When asked why he stated that in all cases it was not the case that the characters got all or every Y, they only got three.

Pattern ALLE	Pattern IEDER	N
Reverse	Reverse	1
Ambiguity	Reverse	5
Ambiguity	Ambiguity	9 ⁸⁷
Ambiguity	Target-like	0
Target-like	Reverse	4
Target-like	Ambiguity	2
Target-like	Target-like	3

Table 4: Individual response patterns for both quantifiers

4.5 Discussion

The results presented in the preceding section suggest that children do not interpret double-object constructions containing the collective universal quantifier *alle* in the same way as sentences containing the distributive universal quantifier *ieder*. Children's performance on *alle* is significantly more target-like than their performance on *ieder*. Furthermore, while the Reverse-pattern is observed more than 35 percent of the time on *ieder* sentences, only one child displayed this pattern on *alle* sentences.

The question now is how these quantifiers differ and whether one of the differences could explain the contrast in performance. As discussed in section 4.4.1, one difference is that *ieder*, like English *every*, is a lexically distributive quantifier, while *alle*, like English *all*, is not. Lexically distributive universal quantifiers can only be used to describe contexts that are distributive. *Alle*, on the other hand, can be used to describe a myriad of different contexts, including collective-action events, collective-responsibility events and prototypically distributive events.

Another interesting finding is that, (even) more often than in previous experiments, children accepted test sentences both for ONE>ALL and for ALL>ONE events. The question is whether these children indeed allow both interpretations of the double-object constructions used in the experiment, or whether this performance pattern has another cause. Yes-responses could be due to many different factors, including a yes-bias. However, such a bias is unlikely given the fact children were able to correctly judge filler items which were false. Since we have almost no justifications for the yes-responses, we cannot be sure what children are doing here. It could be that there is an ambiguity stage in the acquisition of scope freezing, as suggested in the previous chapter, but it could also be that

⁸⁷ The seven 4-year olds who showed an ambiguity response pattern with *ieder* generally also performed this way with *alle*.

these children are like the “Existential Children” of Hollebrandse and Visser (2006).

Hollebrandse and Visser investigated children’s ability to quantify over times rather than objects or events. Therefore they tested Dutch children’s interpretation of the Dutch equivalents of sentences like *Every night a witch is conjuring up an apple*. The crucial test item was a context in which at night 1 a witch is conjuring up an apple, at night 2 a witch is also conjuring up an apple and then during day 1 a witch is not conjuring up an apple. If children quantify over times, then they should judge the test sentence to be true in such a context. If they quantify over some other variable (e.g. events), they are expected to judge the sentence to be false, as during the day the witch is not conjuring an apple. This experiment found that children prefer to quantify over events rather than times. However, more important to us is the high incidence of a response pattern in which children seemed to judge all test statements to be true (Hollebrandse and Visser name the children who display this pattern Existential Children). Almost half of the participating children correctly judged false control items (which did not contain universal quantification) to be false, but judged all test sentences containing a quantifier (*Elke nacht tovert een heks een appel* ‘Every night a witch is conjuring up an apple’) to be true. When asked why they judged the test sentence to be true, they generally referred to one of the subevents in the context. So: “Yes, it is true because this night a witch was conjuring up an apple”. According to Hollebrandse (p.c.) this performance is mainly observed with the younger children. Hollebrandse suggests that these so-called Existential Children do not quantify yet. In our own experiment on *alle* all 4-year olds and about 40 percent of all child participants judge test sentences containing distributive universal quantification to be true, but correctly judge false control items and fillers to be false. Perhaps these children should also be classified as Existential children. In this case, they may judge test sentences to be true in all situations in which there is at least one instance of cake being given to a fox. Since this is the case in both ONE>ALL and ALL>ONE events, these children judge the test sentences to be true in both cases.

4.6 Conclusion

In this chapter we discussed two experiments which investigated children’s interpretation of double-object constructions containing a numeral or a non-obligatorily distributive universal quantifier. The results show that the Reverse-pattern only occurs with distributive universal quantifiers. It is not observed with double-object constructions in which a cardinal quantifier, e.g. *drie* (‘three’) interacts with an indefinite. Furthermore, it hardly ever

occurs with sentences containing the (collective) universal quantifier *alle* ('all'). In fact, only one child showed the Reverse-pattern when presented with ALLE-sentences. The difference between sentences containing the quantifier *ieder* and sentences containing *alle* is highly significant.⁸⁸

This chapter also introduced the Distributivity Hypothesis which claims that the Reverse-pattern is caused by a mismatch between the distributivity that certain quantifiers require and the properties of the context in which it is presented. Five-year-old children have acquired the lexical feature specification of distributive universal quantifiers which includes a distributivity feature. When children encounter such a quantifier, they evaluate whether the context in which it is uttered unambiguously satisfies this distributivity requirement. When this is not the case, children conclude that there is a mismatch between the lexical requirement of the universal quantifier and the situation in which it is used and reject the test statement. This Distributivity Hypothesis predicted that the Reverse-pattern should be limited to quantifiers which force a distributive interpretation of the context, which is indeed the case.

In the next chapter we will investigate the role of distributivity further and we will make the Distributivity Hypothesis more precise. In fact, on the basis of the results of an adult experiment it will be argued that the basic interpretation of distributive universal quantifiers for children as well as for adults is prototypical distributivity, e.g. a form of distributivity in which each element in the restrictor set of the universal quantifier is associated with a distinct subevent. However, adults can accommodate deviations from this pattern, whereas children cannot. It is this mismatch between the event structure that children require and the event structure that they actually see which causes the Reverse-pattern.

⁸⁸ It is this difference which also provides another argument against the claim that the Reverse-pattern is in fact the same phenomenon as Exhaustive pairing (see chapter 2 section 2. 5.3). Exhaustive Pairing occurs with all universal quantifiers, whereas the Reverse-pattern only occurs with a subset of these quantifiers.

Chapter 5

Distributivity

5.1 Introduction

In chapter 4 we investigated the possibility (based on an earlier suggestion by Drozd and Van Loosbroek, 2006) that the Reverse-pattern is limited to a *subset* of universal quantifiers, namely *distributive* universal quantifiers, like Dutch *elk* and *ieder* and English *every*. The results of a Truth-Value Judgment experiment showed that this is indeed the case. Furthermore, we formulated a hypothesis to explain this fact, which we provisionally named the Distributivity Hypothesis. This hypothesis states that children show the Reverse-pattern because they perceive a mismatch between the distributivity features of certain universal quantifiers and the (experimental) contexts in which they were uttered. To be precise, it claimed that children had acquired the lexical specification of distributive universal quantifiers, a specification which includes a requirement for distributivity. However, it further hypothesized that children did not always recognize contexts as distributive when this interpretation of the context is not unambiguously supported.

In this chapter we will retain the gist of the Distributivity Hypothesis, namely that children are aware of the distributivity features of certain universal quantifiers and that these features place demands on the contexts in which these quantifiers are used. We will first investigate what it means to be distributive and exactly what interpretations distributive universal quantifiers allow or require. Furthermore, the role of events and event structure will be examined. A great deal of attention will be paid to Tunstall (1998)'s conditions on the interpretation of distributive universal quantifiers (the Event-distributivity Condition and the Differentiation Condition) and the psychological reality of these conditions. We will discuss a new experiment with adult speakers which examines whether Tunstall's predictions hold. Finally a new hypothesis will be formulated, which will be referred to as the Prototypical Distributivity Hypothesis and which will be presented in both a strong and a weak form. This hypothesis states that the basic interpretation of a distributive universal quantifier is an interpretation in which there is prototypical distributivity, e.g. in which the event structure is fully distributive. Any other interpretation needs to be derived from this basic interpretation. Whereas adults are able to accommodate such

deviations when required, children cannot. This hypothesis is put to the test in a Truth-Value Judgment experiment. However, before turning to experimental evidence, the next section first examines the nature of distributivity and asks whether it is necessary to include events and event structure in the definition of distributivity.

5.2 *Distributivity*

In this section we will further examine what it means to be distributive or to require distributivity. A version of the distributive law (as presented in logic) is presented in (1) below. This law states that the property P that applies to the conjunction of both x and y must also necessarily hold for x and y individually.

$$(1) \quad P(x \text{ and } y) \leftrightarrow (Px) \text{ and } (Py)$$

To see how this applies to language, consider the sentence in (2) containing the distributive predicate ‘sleep’:

$$(2) \quad \text{John and Mary sleep} \leftrightarrow \text{John sleeps and Mary sleeps.}$$

In order for sentence (2) to be true, what applies to the conjunction (John and Mary) also needs to apply to each element of that conjunction, e.g. John must sleep and Mary must sleep. Thus, in order for a proposition to be interpreted as distributive, the property that applies to a set of elements must also necessarily apply to each individual element in that set.

Whether or not a proposition is interpreted distributively is dependent on a variety of different factors. The predicate ‘sleep’ is a distributive predicate and thus forces a distributive interpretation of the noun phrase applied to it.⁸⁹ However, many predicates are consistent with a variety of construals; distributive interpretations, collective-action interpretations, collective-responsibility interpretations etc. An example of such an ‘ambiguous’ predicate is *to sing a song*.⁹⁰ In such cases, a distributive interpretation of the proposition would not be forced by

⁸⁹ A distributive predicate only applies to atomic (singular) individuals.

⁹⁰ In addition, certain predicates force a collective interpretation, for instance *to form a line* and *to gather*. Collective predicates apply to groups and pluralities, but do not apply to the individual elements that make up those groups or pluralities. That is, the sentence *the boys gathered in the kitchen* implies that the group of boys as a whole gathered in the kitchen. However, none of the individual boys has the property of gathering in the kitchen.

properties of the predicate but by the discourse context it is presented in or by the presence of certain lexical items. That is, when a sentence like (3) is presented in a situation in which it is the case that each of the three boys is individually singing a different song, the proposition is more likely to get a distributive interpretation.

- (3) Three boys sing a song.

Furthermore, certain linguistic expressions force distributive or collective interpretations of propositions containing ‘ambiguous’ predicates. In this chapter we will be concerned with a group of expressions that force a distributive interpretation, namely distributive universal quantifiers like *every*, *each* or Dutch *elk* (‘each/every’) and *ieder* (‘each/every’). Consider the sentences in (4):

- (4) a. Every boy is building a tower.
b. All boys are building a tower.

For sentence (4a) to be true every individual boy in the discourse context must have the property of building a tower (or more formally: the property denoted by the predicate of the sentence (e.g. *building a tower*) must hold for each element in the restriction set of the universal quantifier).⁹¹ If one of the boys is not building a tower, then this sentence is false. A quantifier like *all* (see (4b)) does not force such an interpretation. It requires the full set of boys denoted by *all boys* to have the property of building a tower, but does not require every individual boy to have this property. The boys can all work together and not all of the boys necessarily need to be involved in the process of building itself, as long as the group as a whole can be construed as taking part in the process of building a tower. As discussed in chapter 4, the requirement for individuation is what sets distributive universal quantifiers apart from quantifiers like *all*. Whereas the latter is consistent with distributive situations, it is also consistent with collective-action events and collective-responsibility events.

Distributivity thus implies that whatever applies to a larger set also applies to each individual element of this set. Implicit in the above discussion is that distributivity applies to objects. Every object in the restriction set of the universal quantifier needs to have a certain property.

⁹¹ Note that this object-based definition of distributivity retains a degree of vagueness concerning the exact number of towers that are built and the question of whether each of the boys is building a separate tower. When all of the boys are involved in building the same tower, it is still the case that every individual boy has the property of being a tower-builder.

However, in recent years it has become more common to include events in the semantic ontology and to also define distributivity with reference to events. This is the topic of the next section.

5.2.1 *Distribution over Events*

The standard approach to distributivity only makes reference to objects. Every individual object must have the property denoted by the predicate. However, since Davidson (1967) it has become more common to include events into (various areas of) semantics (see for instance Partee, 1984; Kratzer, 1989,2003; Krifka, 1990; Parsons, 1990; Schein, 1993; Landman, 2000; Ramchand, 2007; among many others).⁹²

In essence an event is a situation denoted by a sentence. Following Bach (1986) we take the term event to be shorthand for an ‘eventuality’ and take the class of eventualities to include states and processes as well. Events are semantic objects with an internal structure. However, in this study we will not be concerned with the internal structure of events. Rather we will be concerned with relations between atomic events. When we refer to event structure in this study, we will refer to the relations that obtain between subevents of plural events or sets of events.

The basic assumption is that a predicate is a set of events. These events have participants and these participants are realized as arguments of the predicate. Thematic roles indicate the relations between predicates and their arguments. Parsons (1990) was one of the first to include these event participants into semantic representations, as shown in (5). The representation in (5b) reads: there is an event and this event is an *ordering*-event with John as an agent and a dessert as its theme.

- (5) a. John orders a dessert
 b. $(\exists e) [\text{Order}(e) \wedge \text{Agent}(e, \text{John}) \wedge \text{Theme}(e, \text{dessert})]$ ⁹³

We will now attempt to also include events in the definition of distributivity. There are, in fact, independent arguments for the claim that distributivity must involve events and not merely objects. The strongest argument comes from complex examples that combine cumulative readings with a distributive dependency, and is discussed in detail in Schein (1993).

⁹² Events have proved very useful in the fields of aspect and argument structure, among many others. See the references in the text for more information about the way events have been used to explain a variety of phenomena.

⁹³ Parsons (1990) also adds a conjunct to indicate the tense of the sentence.

However, since explaining this argument would go beyond the scope of this chapter, we will just assume that it is indeed necessary to define distributivity with reference to eventualities.

As shown in section 5.2 object distributivity requires a property that holds for a set to also hold for each individual element in that set. When we add events, this would become something like: Each individual element of a certain set needs to be the unique participant of a subevent of the set of events denoted by the predicate. To see how this would work, consider sentence (6):

(6) John and Mary sleep.

The predicate *sleep* denotes the set of events in which someone sleeps. The distributive interpretation requires there to be a subevent of this set of events in which John is the unique agent of the *sleeping*-event and one in which Mary is the unique agent of a *sleeping*-event.

Let us now attempt to apply this intuition to sentences containing universal quantification, as in (7):

(7) Every boy is building a tower.

The predicate *building a tower* denotes a set of atomic events in which a tower is built by some agent. In order for the sentence to be true, each individual boy in the set denoted by *every boy* needs to be the agent of some event in which he is building a tower, and all of these separate tower-building events need to be subevents of the set of events denoted by the predicate. A fully distributive interpretation of distributive universal quantifiers like *elk* and *ieder* thus requires every member of the restriction set of the universal quantifier to be associated with an atomic event with a unique agent or theme or recipient, depending on the position of the universal quantifier.

We have now given some idea of how events could be incorporated into the definition of distributivity. In the next section we will discuss one account which explicitly incorporates some type of event structure into the meanings adults assign to distributive universal quantifiers, namely Tunstall's (1998) Event-Distributivity account.

5.3. Tunstall (1998): The Event-Distributivity Condition

As shown in the above sections, one could view distributivity as purely object based, in which case it is sufficient if a predicate applies to each object in the restriction set of a universal quantifier individually.

However, more recent approaches have extended this object-based view by also allowing events to play a role in the definition of distributivity. This section will focus on one specific account which relates distributivity to event structure, namely that of Tunstall (1998).

Tunstall focuses on the English distributive universal quantifiers *each* and *every* (and the differences that exist between the two). As discussed in previous sections, both of these quantifiers require at least some degree of distributivity. That is, when “a quantified phrase headed by *each* or *every* is combined with a predicate, the predicate is understood as applying to each individual member of the quantified set rather than to the set as a whole” (Tunstall, 1998: 90). This first requirement is the basic object-distributivity requirement which was discussed in section 5.2. In addition, Tunstall argues, these two distributive quantifiers require “multiple, or distributive, event structures, where the members of their restrictor set are associated with a number of different subevents” (Ibid.).

According to Tunstall, event structures form a scale, with fully distributive event structures (i.e., event structures in which each member of the restrictor set of the quantifier is associated with a distinct subevent) on one end, and non-distributive event structures (e.g. event structures in which there is only a single subevent) on the other. Everything in between is referred to as ‘partially distributive’, a term Tunstall borrows from Lasersohn (1995), though the latter used it in a different way. A (partially) distributive event structure is thus an event structure which contains at least two distinct subevents. In order to clarify the distinctions between the event structures, consider figure 1, which gives three possible event structures for the sentence *John carried every box*.

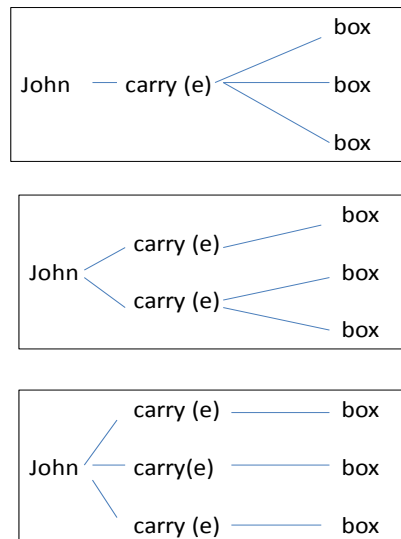

Figure 1: Event Structures for *John carried every box*.

In the topmost structure there is a single *carrying*-event in which John is carrying all of the boxes. This event structure is a non-distributive event structure. The middle structure (the partially distributive event structure) contains two distinct *carrying*-events, one in which John carries a single box, and one in which John carries two boxes. The final event structure is the prototypically distributive event structure in which every individual box is associated with a distinct subevent in which John is carrying it. On a traditional definition of object distributivity, all of the above situations are distributive. However, the addition of events and event-structure allows us to introduce degrees of distributivity and to thus distinguish between the three situations, and to thus differentiate between distributive event structures, partially distributive events structures and non-distributive event structures.

Both *each* and *every* require event structures which are in some way distributive. However, Tunstall argues that the degree to which they need to be distributive differs. Whereas *each* requires prototypical event-distributivity (e.g. every member of the restrictor set needs to be associated with a distinct subevent), *every* merely requires partial distributivity. That is, not every single member of the restrictor set needs to be associated with a distinct subevent, as long as the number of subevents exceeds one. This

difference is formalized in two conditions on the interpretation of these quantifiers, the Event-Distributivity condition, which applies to *every*, and the Differentiation Condition, which applies to *each*.

(8) **The Event-Distributivity Condition:** A sentence containing a quantified phrase headed by *every* can only be true of event structures which are at least partially distributive. At least two different subsets of the restrictor set of the quantified phrase must be associated with correspondingly different subevents, in which the predicate applies to that subset of objects.

(9) **The Differentiation Condition:** A sentence containing a quantified phrase headed by *each* can only be true of event structures which are totally distributive. Each individual object in the restrictor set of the quantified phrase must be associated with its own subevent, in which the predicate applies to that object, and which can be differentiated in some way from the other.

If it is the case, as Tunstall assumes, that the above conditions are part of the lexical meanings of the quantifiers *every* and *each* respectively, then this predicts that, when presented with sentence (10), speakers of English should judge this sentence to be false in a situation in which every cake is given to a single fox (e.g. the ONE>ALL event).

(10) The bear gave a fox every cake.

In the ONE>ALL event presented in the experiments in chapters 2 through 4 all of the cakes are given to a single fox at once. In effect there is only a single subevent (and not at least two). ONE>ALL events thus violate the Event-Distributivity Condition. Why then do adults allow this interpretation?

Let us assume that for adults and children alike the basic interpretation of *every* encodes the Event-Distributivity Condition. We will further crucially assume that under certain conditions, adults can deviate from this basic requirement. That is, when the context does not satisfy event-distributivity but does satisfy the requirements of object distributivity, adults are often able to accommodate this fact.⁹⁴ In the case of sentence (10) the Scope Freezing constraint forces a wide scope interpretation of the indefinite, and thus an interpretation in which a single fox is given all of the

⁹⁴ Recall that object-distributivity merely requires every element in the restrictor set of the universal quantifier to have the property denoted by the predicate.

cakes. This constraint thus forces an interpretation which is not directly compatible with the Event-Distributivity Condition, causing adults to ‘override’ the requirement for an (at least partially) distributive event structure. In a sense Scope Freezing bleeds the Event-Distributivity Condition.⁹⁵

The possibility presents itself that children, unlike adults, strictly adhere to event-distributivity and thus reject test sentences in ONE>ALL events which do not satisfy event-distributivity and accept test sentence in ALL>ONE events which do satisfy this requirement.^{96,97} However, before examining this possibility, it is important to know whether the Event-Distributivity Condition actually holds. Unfortunately, Tunstall does not provide very much empirical evidence. Though she presents evidence which shows that adults do not interpret the English universal quantifiers *every* and *each* in the same way (see Tunstall, 1998, chapter 4), she does not provide unequivocal evidence for the claim that the differences between the two quantifiers are the result of the two distinct lexical conditions which are hypothesized to apply to them (e.g. the Differentiation Condition and the Event-Distributivity Condition).

In this study we are mainly concerned with quantifiers like *every*, and not *each*. We will therefore ignore the Differentiation Condition. However, in the next section we will present a psycholinguistic experiment with adult speakers of Dutch, which was designed to find out whether the

⁹⁵ Tunstall notes that there is a class of examples in which the Event-distributivity condition on *every* does not seem to hold. According to Tunstall “all are cases where the exhaustive nature of the event—the fact that all of the members of the common noun set were affected—is being especially emphasized” (114). In other words, she assumes that whereas generally a sentence like *John is carrying every box* is not true when every box is carried simultaneously (e.g. the non-distributive event structure in figure 1), it can improve when exhaustivity is emphasized and distributivity is de-emphasized. I will assume that there are a variety of reasons why adults can accept event structures that do not comply with Event-Distributivity. This can happen when some other, stronger constraint forces a non-distributive event structure to be acceptable (see the above section), when the exhaustivity of an action is stressed, etc.

⁹⁶ This proposal that children strongly adhere to event-distributivity is reminiscent of the Strongest Meaning Principle as defined by Dalrymple *et al.* (1998) and the Semantic Subset Principle (Crain, 1992).

⁹⁷ Implicit in this account is that children have no knowledge of Scope Freezing/the Frozen Scope Constraint. Alternatively it could be that this constraint is overridden by their strong adherence to the Event-Distributivity Condition (or that in a more optimality-based approach the Event-Distributivity Condition outranks Scope Freezing).

Event-Distributivity Condition on quantifiers of the *every*-type has any psychological reality.

5.4 Experiment VII: Event-Distributivity

In the previous section we introduced Tunstall’s Event-Distributivity Condition, according to which distributive universal quantifiers like *every* (and by extension Dutch *elk* (‘each/every’) and *ieder* (‘each/every’)) require an event structure containing at least two distinct subevents.⁹⁸ Tunstall provides very little empirical evidence for the psychological reality of this condition. This section will therefore discuss an experiment which attempts to fill this gap and assess whether the Event-Distributivity Condition is indeed a condition which applies to universal quantifiers like *every*, *elk* (‘each/every’) and *ieder* (‘each/every’).

Recall that when an event structure contains two or more subevents, event-distributivity is satisfied. When the event structure consists of only a single subevent, this condition is violated. Consequently, a universal quantifier like *every* should not be used to describe such event structures. However, we know that adults must be able to accommodate violations of event-distributivity to some degree, as they tend to judge test sentences to be true of ONE>ALL events in which a single character ends up with all the objects in a single subevent (see the results of the experiments in chapters 2 and 4). Despite this “accommodation”, adults are predicted to have a strong preference for a partially distributive event like (11) over a “collective” ONE>ALL-type event (12). That is, an event structure which satisfies Event-Distributivity should be preferred over an event structure which does not satisfy this condition. This prediction will be put to the test in a picture-selection task.

⁹⁸ In this dissertation we have assumed that Dutch *elk* and *ieder* are comparable to English *every* in the relevant aspects. While the Dutch quantifiers have the same distribution as English *each* (e.g. they can occur in floated position etc.), their interpretation is much closer to English *every* (see Van der Ziel, 2008).

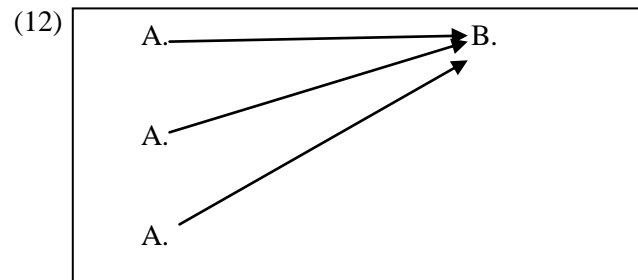
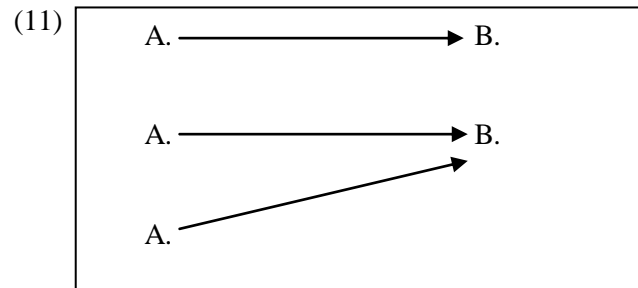

5.4.1 Participants

For this experiment, 93 Dutch-speaking adults (20 men and 73 women) who were between 18 and 52 years of age (mean age 23 years, standard deviation 6 years) were presented with a short task. 17 of these adults were tested individually by a single experimenter. The remaining 76 (all undergraduate students) were presented with a written version of the experiment which they completed in-class.

5.4.2 Design

The data was collected using a picture selection task. Participants were presented with a piece of paper (A4, landscape orientation) which contained a test sentence with two pictures printed above it. Participants were instructed to decide which picture better matched the event described in the test sentence, and to then put a tick in the box beneath the picture of their choice. When participants had made their choice, they were asked two follow-up questions. The first one was: Could the other picture in principle be a good depiction of the test sentence as well? The second question was

whether a situation in which each of the characters had its own object (e.g. a situation in which there was a fully distributive event structure in which the characters and objects were in one-to-one correspondence) would be a good depiction of the test sentence.

One of the two pictures displayed a partially distributive event structure (as in (11) above). The other picture showed an event-structure like (12). We will refer to this latter event structure as a non-distributive event structure.⁹⁹ For example, when the test sentence was *Elk meisje houdt een plant vast* ('Every girl is holding a plant') both pictures would show three girls. In one of the pictures two of the girls would be holding one plant together, while another girl would be holding her own plant, whereas in the other picture all of the girls would be holding a single plant together. The left-right ordering of the pictures was counterbalanced across participants.

The non-distributive event structure in many ways resembled the ONE>ALL events tested in previous experiments. In both ONE>ALL events and the picture presented in this experiment all of the elements in the restrictor set of the universal quantifier are related to a single other element. However, in the experiments described in chapters 2, 3 and 4 the universal quantifier quantified over the objects in the direct object of a double-object construction. All the objects would end up with a single character (e.g. when the test sentence was *The bear gave a fox every cake*, all of the cakes would end up with a single fox). In this experiment, on the other hand, all test sentences were transitive constructions, and the universal quantifier would quantify over the subject of the sentence which in all cases was the agent of the action. As a result, all of the characters were acting on a single object.

The main reason for using transitive sentences of the form *Every X V-ed a Y* instead of double-object constructions or transitive constructions like *A/an X V-ed every Y*, was to avoid interference of scope constraints that exist in double-object constructions (e.g. Scope Freezing) or sentences with an indefinite subject in Dutch (e.g. the Specificity Constraint, see chapter 2 for more discussion). Since in section 5.3 we made the assumption that scope constraints take precedence over event-distributivity, presenting adults with sentences in which scope constraints are operative would obscure the possible application of the Event-Distributivity Condition. However, a consequence of the choice of construction in this experiment is that the non-distributive event structure in this experiment cannot be directly compared to the ONE>ALL situation in previous experiments.

⁹⁹ Note that though the event structure may not be distributive, the situation does satisfy object-distributivity.

The experiment included multiple test and control conditions. However, each participant only saw one of the conditions. The conditions were the following:

condition	number of items ¹⁰⁰	sample sentence
IEDER+INDEF	3	<i>Iedere jongen bouwt een toren</i> Every boy is building a tower.
ELK+ INDEF	2	<i>Elke jongen bouwt een toren.</i> Every boy is building a tower.
ELK+BARE PL3	1	<i>Elke jongen speelt met blokken.</i> Every boy is playing with building blocks
ELK+ BARE PL4	1	<i>Elke jongen speelt met blokken.</i> Every boy is playing with building blocks
ELK+PROPER NAME	1	<i>Elk meisje schildert Sneeuwitje</i> Every girl is painting Snow White
ALLE+INDEF	2	<i>Alle jongens tillen een doos op.</i> All boys are lifting a box (up).

Table 1: Conditions Event-Distributivity Experiment Adults

The IEDER+INDEF and the ELK+INDEF conditions are transitive sentences with a universally quantified subject and an indefinite direct object. Even though no differences were expected between the two sentence-types, as Event-Distributivity is hypothesized to apply to both *elk* and *ieder* in Dutch, both were included for completeness' sake. However, the presence of the indefinite article in these conditions could be problematic. Participants may feel that the use of an indefinite in the test sentence is inappropriate given that the characters have already been introduced in the pictures. They may therefore argue that the test sentence should read *Every X V-ed THE Y*. If the test sentence had contained a definite article, then only the non-distributive picture would have matched the test sentence. Adults may think that if we had meant to refer to the non-distributive picture we would have used the definite article. Since we did not use *the* but *a/an* the correct choice must be the other, partially distributive picture. In other words, the presence

¹⁰⁰ The different number of items per condition is an artifact of the design process of this task. Initially this experiment was only going to include three trials testing the universal quantifier *ieder*. It was later decided to also include the distributive universal quantifier *elk* and the non-obligatorily distributive quantifier *alle*. Two trials were included for both of these quantifiers. All further conditions (e.g. ELK+BARE PL3, ELK+BARE PL4 and ELK+PN) were included at a later stage in order to be able to exclude certain confounding factors. Only one trial of these conditions was included.

of the indefinite article may introduce a confounding factor and inflate the proportion of adults who prefer the partially-distributive picture. For this reason we decided to also include test sentences which did not contain an indefinite article.

The first of these conditions was the ELK+BAREPL3 condition, in which the indefinite direct object was replaced by a bare plural NP like *blokken* ('(building) blocks'), see table 1. Since both of the accompanying pictures showed a large number of building blocks, the use of this bare-plural was felicitous. The second condition that was added was the ELK+PROPER NAME condition in which the direct object is a proper name, namely Snow-White. In one picture a set of girls would be painting a picture of Snow-White together, whereas in the other two girls would be painting a picture of Snow-White together and one girl would be painting a picture of Snow White on her own.

All the above mentioned conditions included a set of three characters, either three girls or three boys. This number of characters was chosen because in previous experiments on double-object constructions the set of plausible recipients of the action had also always consisted of three individuals of a certain type. A consequence of choosing this set-up is that the pictures, particularly the ones displaying a partially distributive event structure, were not symmetrical and felt rather unbalanced. We feared that this could in some way influence adults' preference for certain pictures. Therefore, another condition was added in which four characters (four boys) were involved in the action (ELK+BARE PL4). In one picture all four were involved in a single event together, whereas in the other pictures two sets of two boys were each involved in a certain event. The test sentence that was employed was a sentence containing a bare plural direct object NP. This type of sentence was chosen because of all of the sentence-types used in this experiment, this one was deemed least likely to induce confounding effects.

Finally, a control condition was added in which participants were presented with sentences containing the universal quantifier *alle* ('all'). If we were to find a strong preference for a partially distributive event structure over a non-distributive event-structure in this experiment, then we need to be sure that this preference is induced by specific properties of the distributive universal quantifiers in question, and does not occur with other (universal) quantifiers. Unlike distributive universal quantifiers, the quantifier *alle* does not seem to impose restrictions on the event-types which it describes, (e.g. it is consistent with a large variety of situations including distributive events, collective-action events etc). Therefore, we did not expect adults to have a preference for either the partially-distributive or the non-distributive picture. However, if there is any preference, then we predict this to be a preference

for the non-distributive picture. *Alle* can have a collective interpretation in which its restrictor set is interpreted as a group and not as (a set of) separate individuals. Since the non-distributive picture shows a group of characters involved in the same action, adults who derive a collective interpretation of *alle* might prefer this picture.

5.4.3 Results

5.4.3.1 General Results

The percentages of participants who chose a certain picture-type for each of the conditions are presented in table 2 below:

Condition	N	% 1 st choice Non-Distributive (N)	% 1 st choice Partial Distributivity (N)
IEDER+INDEF	29	34.5 (10)	65.5 (19)
ELK+INDEF	21	23.8 (5)	76.2 (16)
ELK+BARE PL3	10	30 (3)	70 (7)
ELK+BARE PL4	9	33.3 (3)	66.7 (6)
ELK+PROPER NAME	7	71.4 (5)	28.6 (2)
ALLE+ INDEF	17	64.7 (11)	35.3 (6)

Table 2: Results per condition

As shown in the above table, in the case of IEDER + INDEF, ELK + INDEF, ELK+BAREPL3, ELK+ BAREPL4, adults have a preference for the partially distributive choice over the picture with the non-distributive event structure. Superficially this preference seems to be the strongest in the case of the ELK+INDEF condition. The exception to the rule, however, is the ELK+ Proper Name condition, in which there is a preference for the non-distributive picture. When presented with control sentences containing the non-obligatorily distributive universal quantifier *alle*, adults had a preference for the non-distributive picture.

A Kruskal-Wallis test did not reveal any significant differences between the six conditions above ($X^2(5) = 10.354$ $P \geq .066$). However, the non-significance of this test can partly be related to the relatively small cell counts in certain of the conditions (see table 2). In order to increase the cell-count, we combined the the IEDER + INDEF, ELK + INDEF, ELK+BAREPL3, ELK+ BAREPL4 condition and compared the pooled results to the results on the ALLE+INDEF condition. A Mann-Whitney test revealed a significant difference between the two (Mann-Whitney $U = 345.6$, $Z = -2.153$, $p \geq .031^*$). In addition we compared the combined results on the

above mentioned four conditions to the chance level (.5) by using a binomial test. The results show that the combined results on these conditions are significantly different from chance ($p \geq .002^{**}$).

5.4.3.2. *Individual Responses*

In the picture selection task we not only asked adults to pick the picture that better matched the test sentence, but we also asked them two follow-up questions. The first was whether the other picture could also in principle match the test sentence. We expected most adults to answer this question affirmatively. Partial distributivity should be part of the lexical meaning of the distributive universal quantifiers and adults should therefore always allow this picture to be a good depiction of the test sentence. The picture showing the non-distributive event structure did not satisfy the Event-Distributivity Condition, but in principle adults should be able to accommodate situations like this, e.g. situations that deviate from the preferred distributive event structure but satisfy the less stringent requirements of object distributivity. In a way, the mere posing of the follow-up question forces adults to consciously attempt to accommodate dispreferred event structures. This does not mean that all adults will be able to deviate from their preferred interpretation. However, we do predict that if adults are able to accept the non-distributive event structure, then they should also always accept the partially distributive event structure. However, the reverse does not necessarily hold.

The responses to this follow-up question indicated that, as expected, most adults in principle allowed both pictures to depict the target sentence, though they generally had a slight preference for one of them. However, 19 adults stated that only one of the pictures matched the test sentence. Eleven of them only allowed a partially distributive event structure, while eight of them only allowed the non-distributive event structure. Two of the adults who only allowed a partially distributive event structure told the experimenter that the non-distributive event structure did not match the test sentence, because the test sentence contained an indefinite article and not a definite article. In other words, to be able to accept the non-distributive situation the test sentence should have been: *Every X V-ed THE Y*. This shows that we were right to be concerned about the possible confounding effect of the presence of the indefinite article (see section 4.5.2). When we remove these two adults, we are left with 9 adults who only allow partial distributivity and 8 adults who only allow the non-distributive picture. The prediction that adults who only allow a single picture would select the partially distributive picture was not borne out.

In addition, in a second follow-up question adults were asked to imagine a situation in which the set of characters and the set of objects were in one-to-one correspondence, e.g. a situation in which there was full distributivity. They were then asked whether the test sentence matched this situation as well. All adults (except one) stated that this type of situation would be acceptable, and in fact would be preferable to the two picture choices presented in this experiment.¹⁰¹ Many adults, while answering the first follow-up question noted that while in principle both of the partially-distributive event structure and the non-distributive event structure were possible, they felt that both choices were slightly degraded. These participants often stated that they would have preferred a picture in which each participant was associated with a single distinct object. In other words, they would have preferred a fully distributive picture.

5.4.4 Discussion

A prediction of the Event-Distributivity Account was that, when presented with a sentence containing a distributive universal quantifier like *every*, adults should always have a preference for a partially distributive event structure over a non-distributive event structure. The results of the picture selection task indeed show this preference for most of the conditions, e.g. ELK+INDEF, IEDER+INDEF, ELK+BAREPL3, ELK+BAREPL4. In addition, this preference for a partially-distributive event structure appears to be limited to sentences containing a distributive universal quantifier. When adults are presented with the (collective) universal quantifier *alle*, they prefer the non-distributive picture over the partially distributive picture.

However, the results on the ELK+ PN condition are puzzling. We predicted that for all conditions with a distributive universal quantifier in subject position participants should prefer the partially-distributive event structure. However, in this condition adults preferred the non-distributive event structure.¹⁰² We could argue that the presence of the proper noun ('Snow White') strongly biases adults towards choosing the non-distributive event structure in which only one unique exemplar of Snow-White is present, and that this bias overrides the preference for partial distributivity dictated by the Event-Distributivity Condition. Generally when using a proper name one refers to a single unique referent in the universe of

¹⁰¹ The one adult who did not allow the fully-distributive event structure was one of the adults who saw the ELK+PN condition. This adult only judged the non-distributive event structure to be consistent with the test sentence.

¹⁰² Though the results for this condition are surprising, we do have to be careful in our interpretation of these results given the relatively small number of adults who judged this condition (N=7).

discourse. This is the case in the non-distributive event structure, but not in the partially distributive event structure in which there are two exemplars of ‘Snow White’. Alternatively we could take the result on the ELK+PN condition as counterevidence against the Event-Distributivity Account. If partial event-distributivity is really part of the lexical make-up of distributive universal quantifiers, then should this not override any biases induced by the other lexical items?

In other words, though the predicted preference for partially-distributive event structures is observed for many of the conditions, this preference is not always observed. In addition, the responses on the follow-up question show that in fact some adults (N=9) do not allow *every* to be used in a partially distributive event structure at all. Finally, most adults made clear that they actually preferred a fully distributive event structure to the two options that were presented in the experiment. For many adults both the partially-distributive event structure and the non-distributive event structure were equally degraded and dispreferred.

Based on the above described results, we will hypothesize that the lexical meaning of a distributive universal quantifier does not include a requirement for partial distributivity. Rather, we will argue that it encodes a requirement for fully distributive or prototypically distributive event structures. Adults can deviate from this basic interpretation through processes of pragmatic inference, but not all of these deviations are equally acceptable. Certain event-structures are easier to ‘accommodate’ than others.¹⁰³ Both of the event structures presented in the picture-selection task are suboptimal, but for most adults the partially-distributive event structure is easier to accommodate. This could be because in this case there is at least some degree of distributivity. At least some of the characters are associated with distinct subevents, and therefore this event structure may be felt to be more similar to the ideal event structure. However, for some adults, the non-distributive event-structure may be easier to accommodate. Perhaps for them it is ‘all or nothing’, that is either full-event-distributivity or no event-

¹⁰³ In this dissertation we use the term accommodation to denote a process by which a language user reinterprets the (experimental or discourse) context in order to make it compatible with the requirements of prototypical distributivity. In other words, if a situation that does not satisfy prototypical distributivity can in some way be reinterpreted as a prototypically distributive event, for instance by ‘imagining’ the implicit presence of distinct subevents, accommodation is said to take place. This way of viewing accommodation differs from the presuppositional type of accommodation as discussed in Lewis (1979) and Stalnaker (1973, 1974, 1978), among many others.

distributivity at all. The account sketched in this section will be worked out in the following section.

5.5 Experiment VIII: Prototypical Distributivity

In this section, we continue assuming that the basic interpretation of a distributive universal quantifier is a fully distributive or PROTOTYPICALLY DISTRIBUTIVE interpretation, and that all deviations from this pattern need to be derived from the basic interpretation in some way. For the time being we will assume that diversion from the canonical interpretation can occur for a variety of different reasons. In the case of adults' acceptance of test sentences in ONE>ALL events (e.g. events in which one character gets all of the objects) the application of a stronger constraint (e.g. the Frozen Scope Constraint) may force a deviation from prototypical distributivity. We will assume that any deviation from prototypical distributivity is derived through pragmatic inference, or through some process of 'accommodation' (Lewis, 1979). We will return to this issue in chapter 6.

It seems reasonable to assume that the acceptability of deviations from this prototypical interpretation depends on just how serious the 'violation' or deviation is. Not all deviations will be on the same level or be equally acceptable. For now we will adhere to the scale proposed by Tunstall, and assume that event structures with a single subevent constitute the strongest violation, with different types of partially distributive event structures somewhere intermediate. When a situation does not even satisfy object-distributivity (e.g. the requirement that each individual element in the restrictor set of the universal quantifier has the property denoted by the predicate), no amount of 'accommodation' will make a sentence containing a distributive universal quantifier a good description of such a situation. One could even capture the difference between *each* and *every* in this approach by assuming that the main difference between the two is the degree to which they tolerate violations of prototypical distributivity. That is, *each* is relatively resistant to 'violations' of prototypical distributivity, whereas *every* is more liberal.

In a way prototypical distributivity is similar to the Differentiation Condition which Tunstall proposed for the universal quantifier *each*. The Differentiation Condition is repeated in (13).

(13) **Differentiation Condition**

A sentence containing a quantified phrase headed by *each* can only be true of event structures which are totally distributive. Each individual object in the restrictor set of the quantified phrase must be associated with its own subevent, in which the predicate applies to that object, and which can be differentiated in some way from the other.

However, unlike the Differentiation Condition, the novel hypotheses proposed here do not apply to a single universal quantifier. Rather, they apply to both *each* and *every*, and all other universal quantifiers which belong to the same type.¹⁰⁴ Consider the condition in (14):

(14) **The Weak Prototypical Distributivity Hypothesis:**

Distributive universal quantifiers force a prototypically distributive event structure, i.e. an event structure in which every element in the restrictor set of the universal quantifier is associated with a distinct subevent. However, adults can deviate from this prototypical interpretation, whereas children cannot.

According to the above hypothesis distributive universal quantifiers require a fully distributive event structure. In the case of a sentence like (15), it requires that every individual boy indeed kissed a girl.

(15) Every boy kissed a girl.

If the group of boys consists of Tom, John and Pete, then it needs to be the case that Tom kissed a girl, John kissed a girl and that Pete kissed a girl. However, the Weak Prototypical Distributivity Hypothesis does not put any requirements on the total number of girls that are the patients of the *kissing*-events, and thus retains a degree of vagueness. There could be a distinct girl for each boy, or one and the same girl for all the boys, as long as the actual *kissing*-events are spatio-temporally distinct.

We will, however, also include a stronger hypothesis, which limits the number of situations which are consistent with the prototypical distributivity account. Consider the Strong Prototypical Distributivity Hypothesis in (16) below:

¹⁰⁴ This type of quantifier is often referred to as a distributive-key universal quantifier (see Gil, 1995).

(16) **The Strong Prototypical Distributivity Hypothesis:**

Distributive universal quantifiers force a prototypically distributive event structure, i.e. an event structure in which every element in the restrictor set of the universal quantifier is associated with a distinct subevent. *In addition, these subevents need to be unique.* However, adults can deviate from this prototypical interpretation, whereas children cannot.

The Strong Prototypical Distributivity Hypothesis not only requires every element in the restrictor set of the universal quantifier to be associated with a distinct subevent, but also requires these subevents to be non-overlapping. In the case of (15) it not only requires each individual boy to be involved in a separate *kissing*-event, but it also prohibits overlap between the *kissing*-events. In other words, each boy needs to kiss a different girl. It thus requires every element of the set of boys to be in one-to-one correspondence with some element of the set of girls (comparable to the ALL>ONE event presented in earlier experiments). One could also say that there is some kind of exclusivity requirement. This requirement can be compared to something like the One-One Principle in counting (see Gelman and Gallistel, 1978). When counting a set of objects, this principle ensures that each number is associated with a single object, and that once an object has been counted, it cannot be counted again. So in the case of *Every boy kissed a girl*, when a girl has been kissed, this makes her unavailable for further kissing by another boy.

However, while the above formulation of the Strong Prototypical Distributivity Hypothesis can be easily applied to mono-transitive sentences, in this dissertation we are mainly concerned with double-object constructions in which there are three sets of participants for each subevent. That is, there is an agent, a set of recipients and a set of objects (themes). If each subevent needs to be completely unique, then this would imply that each subevent would need a unique agent, a unique recipient and a unique theme. This, however, is not what we want to claim. We want there to be a one-to-one relation between the set of recipients and the set of objects/themes without placing requirements on the number of events involving the agent. Thus, for a sentence like *The bear gave a fox every cake* we want each individual cake to be given to a different fox, but we do not want each subevent to have a unique bear as a participant. At this point we will provisionally assume that ‘the bear’ is excluded from consideration by virtue of the definite article which prevents it from entering into scope

interaction and therefore exempts it from the requirements of the Strong Prototypical Distributivity Hypothesis.

A further discussion point is why children would be unable to deviate from prototypical distributivity, while adults can. Above we made the assumption that any deviation from prototypical distributivity is derived through pragmatic inferencing and the process of accommodation. We know that accommodation and processes of discourse integration are acquired late (see Krämer (2000) and references therein), so we will for now assume that children generally fail to accommodate deviations because they do not have sufficient command of the required pragmatic skills yet. Adults, on the other hand, should have the required skills and should be able to accommodate, though they may not always do so. We will return to this in more detail in chapter 6.

To summarize, in this section we have introduced two versions of the Prototypical Distributivity Hypothesis. A weak version, which merely requires distinct subevents for each element in the restrictor set of the universal quantifiers, and a strong version which also requires each subevent to be unique (and thus non-overlapping). The two Prototypical Distributivity Hypotheses will now be put to the test in a Truth-Value Judgment experiment in which Dutch-speaking children are presented with double-object constructions in a number of situations which either satisfy prototypical distributivity or deviate from it in various ways.

5.5.1 Participants

This experiment was conducted at a single school in the Utrecht (NL) area. 41 Dutch-speaking children participated. These children were on average 5;7 years old (age rang 4;3 -6;11, SD 7 months). The group consisted of 16 girls and 25 boys. In addition, 31 adults completed a slightly modified version of the experiment. The adult controls were between 21 and 61 years of age, mean age 31 years (SD 10 years). The group consisted of 10 men and 21 women, some of whom were students (but none of them studied linguistics).

5.5.2 Design and Procedure

Children (and adults) were presented with a Truth-Value Judgment task with picture stories. The general procedure of this experiment was the same as in the Truth-Value Judgment experiments discussed in previous chapters. Just as in the experiments discussed in the previous chapters, children were presented with a set of four stories (plus a warm-up story)

accompanied by pictures. All of the control and test conditions will be discussed briefly below. These conditions were interspersed with a selection of filler items which were either obviously true or obviously false statements about the story (often statements about the appearance of the main characters or the place where the action was taking place). None of the filler items contained universal quantification.

5.5.2.1 Control Conditions

The first control condition tested children's basic understanding of distributive universal quantification by presenting participants with simple test statements of the form *Every ('Elke') X V-ed a Y*. These statements were either true (e.g. when all Xs indeed V-ed a Y) or false (e.g. when some but not all of the X V-ed a Y). The items of this control condition will be referred to as Quantifier Control True (QCT) or Quantifier Control False (QCF). There were two trials of each of the quantifier control conditions.

Further control conditions tested children's interpretation of double-object constructions in exactly those situations which had been tested in previous experiments. These controls served to determine which children showed the Reverse-pattern under normal (unmodified) circumstances. The first condition (DOA) tested children's interpretation of double object constructions like (17) in ONE>ALL events, e.g. an event in which a single fox got every cake.

- (17) *De beer heeft een vos elke taart gegeven*
 the bear has a fox every cake given
 'The bear gave a fox every cake'.

The second condition (DAO) tested children's interpretation of the above construction in an ALL>ONE event, e.g. an event in which all of the cakes were equally distributed over a group of foxes (exhausting both the set of cakes and the set of foxes). Children were presented with a single trial of both conditions.

5.5.2.2. Test conditions

In order to test the two Prototypical Distributivity Hypotheses which were put forward in section 5.5 above, this experiment adapted the contexts in which double object constructions of the form *The bear gave a fox every cake* were presented. Both the strong and the weak version of the Prototypical Distributivity Hypothesis predict 'no'-responses for any situation that deviates from prototypical distributivity, though they differ as

to the exact definition of prototypical distributivity. However, both hypotheses agree that at the very least each element in the domain of the universal quantifier needs to be associated with a distinct subevent. When children are presented with situations in which this is not the case (e.g. partially distributive situations), children should reject the test statements. In addition, the Strong Prototypical Distributivity Hypothesis adds some sort of Exclusivity Requirement, that is, it requires the participants of the subevents (or at least the Recipients and the Themes) to be unique. If children are presented with a situation in which each element in the restriction set of the universal quantifier is associated with a distinct subevent, but the participants of these subevents overlap to some degree, non-targetlike performance should ensue. The Weak Prototypical Distributivity Hypothesis does not impose such conditions and hence predicts targetlike performance when the subevents are spatio-temporally distinct, but the same individual(s) is/are participants in more than one subevent. This prediction is put to the test in Event Separation Conditions. Let us now discuss each condition in turn.

The first test condition is called Non-Prototypical Distributivity Extra (NPDE). In this condition a sentence like (18) was presented in a partially distributive event structure. For sentence (18) there would be a bear, three foxes, three cakes and a cookie. One of the foxes would get one cake, one gets two (in a single subevent) and one gets the cookie. A simplified event structure is presented in (19).

- (18) *De beer heeft een vos elke taart gegeven*
 the bear has a fox every cake given
 ‘The bear gave a fox every cake’

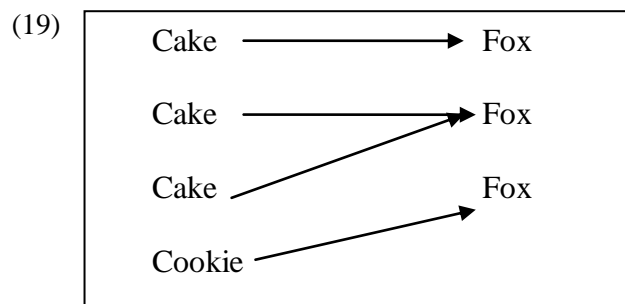

The name of this condition derives from the fact that the event structure does not satisfy the conditions of either of the Prototypical Event-distributivity Hypotheses, and the fact that an ‘extra’ character, namely one of the foxes, is

not part of a *cake-giving* event, but rather of a *cookie-giving* event. Since not all cakes are associated with distinct subevents (e.g. two of the cakes are given to a fox in a single subevent), both of the Prototypical Distributivity Hypotheses predict that children will reject test sentences presented in this event type.

The second test condition will be referred to as Non-Prototypical Distributivity Full (NPDF). This condition also tests a partially distributive situation. However, it differs from NPDE in that the set of cakes and the set of foxes are exhaustively paired, even though this pairing is not one-to-one. That is, there would be FOUR cakes and three foxes and each fox would get at least one cake (and one gets two), as in (20) below. The fox that gets two cakes is given those cakes in a single *giving*-event.

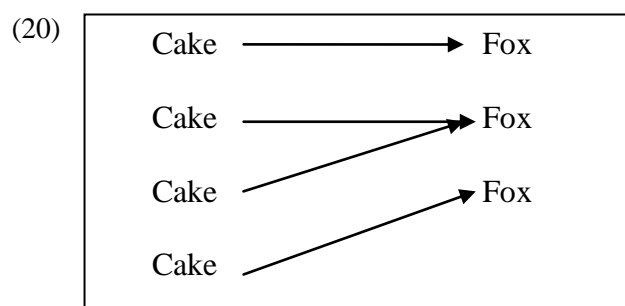

Both the weak and the strong Prototypical Distributivity Hypotheses predict that children will reject the test sentence for both NPDE and NPDF, as neither satisfies prototypical distributivity. The reason is that in neither situation each element of the restrictor set of the universal quantifier (e.g. the elements in the set of cakes) is associated with a different subevent.

However, the predictions of the strong and the weak version of the Prototypical Distributivity Hypothesis start to diverge when the event structure is distributive, but objects or participants are “re-used”. The weak version requires a distinct subevent for each object in the restrictor set of the universal quantifier, but remains vague as to the number of other objects. That is, with a sentence like *The bear gave a fox every cake* it allows there to be a single fox, as long as there is a distinct giving-event for each of the cakes. The strong version, however, requires the foxes to be distinct as well. Thus, if we present children with a situation in which a single fox ends up with every cake in a distributive event structure, the weak hypothesis predicts that children will accept test sentences in this situation, whereas according to the strong version they should reject them. This type of situation is presented in the Event Separation Conditions. These conditions

are described in (21) and 0 below, and a schematic representation of the event structure is presented in (23):

- (21) Event Separation 1 (ES1) = a sentence like (18) presented in a modified ONE>ALL event in which each element in the restriction set of the universal quantifier is associated with a distinct subevent (i.e. every cake is given to a single fox but the cakes are given one by one (both visually and in the text)).
- (22) Event Separation 2 (ES2) = a sentence like (18) presented in a modified ONE>ALL event in which each element in the restriction set of the universal quantifier is associated with a distinct subevent. However, the events are only individuated in the story and not in the pictures.

(23)

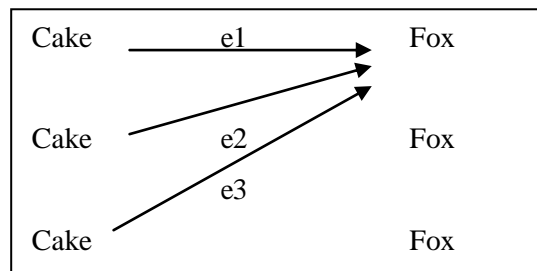

As stated above, if children adhere to the Strong Prototypical Distributivity Condition then they are expected to reject the test statements for both the ES1 and the ES2 condition. If children adhere to the Weak Prototypical Distributivity Condition, then they should be able to accept ES1 and ES2, assuming, of course, that the event separation is “sufficient”. In the case of ES1 event separation is both orally and visually stressed. In the case of ES2 it is only orally stressed, and the question is whether this is enough.

In section 5.4, an adult experiment was presented which tested the psychological reality of the Event-distributivity Condition as described in Tunstall (1998). In that experiment transitive constructions were included instead of double-object constructions. In the last two conditions of this child experiment, children’s interpretations of transitive sentences with a universally quantified subject and an indefinite object were investigated. Children were confronted with situations in which either all members of a

group of characters are collectively involved in some action, or in which two of a group are involved in a certain action together whereas a third character is involved in that action by him/herself. A short description of the two conditions and the relevant event structures are presented in (24) and (25) below, the event structures:

- (24) Transitive Partial Distributivity (TPD) = a transitive sentence of the form *Every X V-ed a Y* in a partially distributive situation (i.e. three girls and 2 balloons, two girls are holding a balloon together and one is holding her own balloon).

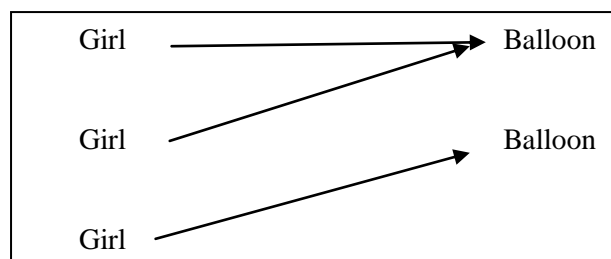

- (25) Transitive Collective (TC) = a transitive sentences of the form *Every X V-ed a Y* in a collective-action event (i.e. three girls are holding cotton candy together).

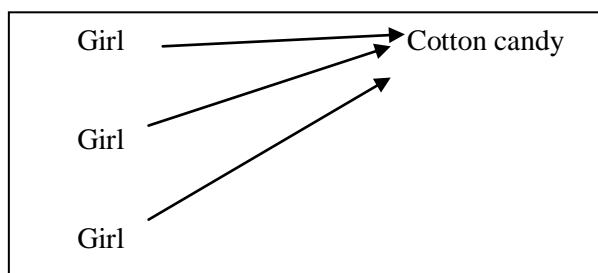

Both versions of the Prototypical Distributivity Hypothesis lead us to predict that children would reject test sentences in both TPD and TC situations, as neither situation satisfies the requirement for distinct subevents. In the TC condition there would only be a single subevent, whereas in the TPD condition the event structure is merely partially distributive.

For convenience an overview of the conditions and the predicted responses is presented in table 3.

Condition	Strong PDH	Weak PDH
NPDE	false	false
NPDF	false	false
ES1	false	true
ES2	false	true or false ¹⁰⁵
TPD	false	false
TC	false	false
DOA (control)	false	false
DAO (control)	true	true

Table 3: Predictions per hypothesis

All children were presented with a single trial of the DOA, DAO, TC and TPD conditions. In addition, half of the children saw two trials of NPDE and ES1; the other half saw two trials of both NPDF and ES2. The TPD and TC conditions were always presented in the first story. The ordering of the other trials was counterbalanced across participants.

5.5.3 Results

5.5.3.1. Results Child Participants

The child participants in this experiment performed at least 80% accurate on the QCT and QCF quantifier control conditions, as shown in table 4.¹⁰⁶ Given this high percentage of accuracy, no children were excluded from analysis.

control condition	N items	total N trials	target response	% accurate
QCT	3	121	true	80.4
QCF	2	81	false	93.8

Table 4: Accuracy on control items

In this experiment, children rejected the test statements of the DOA condition on 63.4% of the trials (see table 5). When presented with the DAO

¹⁰⁵ If enforcing event separation in the story (but not the pictures) is sufficient for children to interpret the event structure distributively, then children are expected to accept the test statement. If not, children should reject it.

¹⁰⁶ No child failed more than two of the control trials.

condition (e.g. the distributive condition), children accepted the test statement 79.5% of the time on test trials. Recall that in chapter 2 (experiment I) children rejected the double-object test-construction presented in a traditional ONE>ALL event (e.g. the DOA condition) 68.7% of the time and accepted the same sentence type presented in a distributive context (e.g. an ALL>ONE event) on average 83.3% of the time. This experiment thus robustly replicates the results of previous experiments with regard to child performance on unmodified ONE>ALL and ALL>ONE events.

Let us now turn to the Non-Prototypical Distributivity conditions (NPDE, NPDF), which investigated children's interpretation of test sentences in contexts which could be conceived as being midway between a ONE>ALL event and an ALL>ONE event (see table 5 for the exact percentages per condition).

condition	total n of trials	%true (N)
NPDE	46	19.6 (9)
NPDF	34	85.3 (29)
ES1	46	39.1 (18)
ES2	34	17.6 (6)
TPD	41	82.9 (34)
TC	41	73.2 (30)
DOA	41	36.6 (15)
DAO	39	79.5 (31)

Table 5: Percentage 'yes'-responses per condition

The NPDE modification saw all elements of the restriction set of the universal quantifier having a certain property. However, they did not end up in a one-to-one correspondence with a set of characters. Rather, one of the characters got two Xs, one got one X and one got something else. So when presented with the test sentence *The bear gave a fox every cake*, the context was such that one fox got two cakes (in one subevent), one got a single cake, and one got a cookie. In other words, the event structure of the context did not conform to prototypical distributivity. In the case of NPDE children rejected test sentences about 80.4% of the time.

The NPDF condition tested cases in which there was an exhaustive pairing of objects and characters, but not a one-to-one correspondence, for example: each giraffe would get at least one apple, but one giraffe got two (in a single subevent). In this case neither of the Prototypical Distributivity Hypotheses is met. Children accepted NPDF sentences 85.3% of the time. A Mann-Whitney test revealed a highly significant difference between NDPE vs. NPDF: $p < .001$ (**).

In the ES1 and ES2 conditions a ONE>ALL event (see DOA) was modified by introducing a separate subevent for each element in the restrictor set, but still having only a single recipient. The results on ES1 and ES2 (see table 5) showed that this modification did not have any effect. The ES2 condition displaying event separation in the story alone did not see an increased acceptance of the test sentences. In fact, there is a decrease in acceptance compared to DOA, although this difference is not significant ($p \geq .317$). The ES1 condition, in which event separation was induced both in the story and in the accompanying pictures, did not induce a higher acceptance rate either. Children still rejected the test sentences about 60% of the time.

As for the TC and TPD-conditions, e.g. the transitive sentences presented in either a “collective” situation or a partially distributive situation, children tended to accept test sentences for both conditions. Children accepted the TPD condition on 82.9% of the trials, and children also accepted the TC condition on 73.2% of trials. Both responses are inconsistent with the Prototypical Distributivity Hypotheses.

Further analyses showed that children’s performance was not affected by their gender ($p \geq .32$) or the group they were in at school ($p \geq .33$). The version of the task (which determined the ordering of the test stories) also did not affect children’s judgments ($> .057$). The children were divided into three age groups: the 4-year olds (4;3-4;11, $N=11$), the 5-year olds (5;0-5;11, $N=17$) and the 6-year olds (6;0-6;11, $N=13$). A Kruskal-Wallis test revealed significant differences for DOA ($X^2(2) = 8.26$, $p \geq .016$), ES1 ($N=7,6,9$: $X^2(2) = 9.82$, $p \geq .007$), ES2 ($N=3,10,4$: $X^2(2) = 6.825$, $p \geq .033$) and NPD2 ($N=3,10,4$: $X^2(2) = 7.024$, $p \geq .030$). The small cell-counts for ES1, ES2 and NPD2 make the results for these conditions slightly less trustworthy. However, when looking at the mean ranks, it is clear that in all cases the largest amount of acceptances of test statements occurs in the group of 4-year olds. A similar result was obtained in chapter 4 where the Ambiguity-pattern (e.g. accepting test statements in both ALL>ONE and ONE>ALL events) was most often observed with the youngest age group, see sections 4.4.4.1 and 4.5.

5.5.3.2 Individual Analysis Children

Just like in the previous experiments the individual response patterns of the children were also examined. We were particularly interested in the response patterns of those children who showed the Reverse-pattern on the DOA and DAO control conditions. The Weak Prototypical Distributivity Hypothesis would predict that children who show the Reverse-pattern on DOA/DAO would also reject test sentences for NPDE, NPDF, TPD and TC,

and accept them for ES1 and possibly accept them for ES2. The Strong Prototypical Distributivity Hypothesis would predict children who show the Reverse-pattern on the control conditions to reject all test sentences for NPDE, NPDE, ES1, ES2, TC and TPD. We know that when looking at the general results for all of the children these predictions do not hold (see section 5.5.3.1). However, they could hold for the subgroup of children who showed the Reverse-pattern on the DOA and DAO conditions.

Recall that half the children were presented with NPDE and ES1, while the other half was presented with NPDE and ES2. The results for the former two conditions are presented in table 6, and the results for the latter two are presented in table 7. All of the children were presented with the TPD and TC conditions.

DOA vs. DAO	N	NPDE	N	ES1	N	TPD	N	TC	N
Reverse-pattern	11	false	11	false	9	true	10	true	9
				mixed ¹⁰⁷	2	false	1	false	2

Table 6: Child responses on NPDE, ES1, TPD and TC

DOA vs. DAO	N	NPDE	N	ES2	N	TPD	N	TC	N
Reverse-pattern	12	true	11	false	12	true	9	true	8
		mixed	1			false	3	false	4

Table 7: Child responses on NPDE, ES2, TPD and TC

Let us first examine the performance of the children who were presented with NPDE and ES1. All of the children who showed the Reverse-pattern on the DOA/DAO conditions rejected the NPDE condition, and nearly all of them also rejected the ES1 condition (nine did so on both trials, and two did so on one of the two trials). This result is consistent with the Strong Prototypical Distributivity Hypothesis and suggests (but does not prove) that whatever causes the Reverse-pattern also causes children's rejection of NPDE and ES1. The children who saw the ES2 and the NPDE condition (see table 7) and who showed the Reverse-pattern on the controls also always rejected ES2. Furthermore, they nearly always accepted NPDE (only one child rejected it on one of the trials). Again this is suggestive, and tentatively supports the claim that whatever causes the Reverse-pattern also

¹⁰⁷ A 'mixed' response meant either that children judged a test sentence true on one trial of a certain condition and false on another, or that children failed to judge one of the trials.

leads children to accept NPDE and reject ES2. However, these individual response patterns present counterevidence against both of the Prototypical Distributivity Hypotheses, as children were expected to reject the NPDE condition. All of the children saw the TPD and TC conditions. Children who showed the Reverse Pattern tended to judge test sentences of the TPD and TC conditions to be true. This again provides counterevidence against the two Prototypical Distributivity Hypotheses.

A total of 8 children showed the Ambiguity-pattern on DOA and DAO. That is these children accepted test sentences in both ONE>ALL and ALL>ONE events. When presented with the other test conditions, these children always accepted the TPD and TC conditions and the Event Separation conditions (ES1 and ES2). Their performance on the other conditions (NPDE, NPDE) was less consistent. Six children performed target-like on DOA/DAO and thus accepted test sentences in ONE>ALL events and rejected them in ALL>ONE events. These children tended to accept the ES1 and ES2 condition, but did not show a consistent response pattern on the other conditions. The exact results for children showing the Ambiguity-pattern or the target-like pattern can be found in appendix 7.

To conclude, when we consider the individual response patterns, the predictions of the Prototypical Distributivity Hypotheses are not borne out. Individual children who show the Reverse-pattern do not perform as expected on the other conditions. However, those children who show the Reverse-pattern do show a relatively consistent performance pattern on the other test conditions. That is, they all tend to reject ES1, ES2 and NPDE and accept NPDE, TC and TPD. In other words, even though the children do not show the response pattern that was predicted by the Prototypical Distributivity Hypotheses, there does seem to be a relation between children's performance on DOA/DAO and their performance on the other conditions.

5.5.3.3 General Results Adults

Adults, who obey the Frozen Scope Constraint, should show the global response pattern presented in table 8. Since the Frozen Scope Constraint only allows a sentence like *The bear gave a fox every cake* to have the interpretation where a single fox gets all the cakes, adults are expected to accept all situations in which this is the case (DOA, ES1, ES2) and reject all situations in which this does not hold (DAO, NPDE, NPDE). In the case of TPD and TC, the results of the picture selection task described in section 5.4 led us to expect that adults would accept the test sentences in the TPD and TC conditions. That is, in that experiment most adults in principle

allowed both the picture depicting a partially distributive event structure (similar to TPD) and the picture depicting a non-distributive event structure (similar to TC). Both of the situations present a deviation from prototypical distributivity, but adults are expected to be able to accommodate these deviations.

Condition	Predicted response
NPDE	NO
NPDF	NO
ES1	YES
ES2	YES
TPD	TRUE
TC	TRUE
DOA	YES
DAO	NO

Table 8: Predicted responses adults

The results of the adult participants are presented below:

condition	total n of trials	%true (N)
NPDE	28	28.6 (8)
NPDF	34	29.4 (10)
ES1	28	89.3 (25)
ES2	34	88.25 (30)
TPD	31	45.2 (14)
TC	31	45.2 (14)
DOA	31	80.6 (25)
DAO	31	38.7 (12)

Table 9: Percentage Acceptance per Condition

As table 9 above shows, adult performance is not uniform. However, on the whole the responses do follow the predicted pattern, with the exception of TC and TPD. Adults generally accept DOA, ES1 and ES2. Furthermore, adults also tend to reject DAO, NPDE and NPF. However, they do not accept TPD and TC, and instead reject them more than half of the time (e.g. 54.8% of the time).

The individual response patterns of the adult participants were also examined. There were 6 adults (out of a total of 31) who showed the Reverse-pattern. Their response patterns on the other conditions are presented in the tables below. The results for NPDE and ES1 can be found in table 10, the results for NPDF and ES2 are presented in table 11.

DOA vs. DAO	N	NPDE	N	ES1	N	TPD	N	TC	N
Reverse-pattern	3	true	1	true	1	true	2	true	2
		false	2	false	1	false	1	false	1
				mixed	1				

Table 10: Adult Performance on NPDE, ES1, TPD and TC

DOA vs. DAO	N	NPDF	N	ES2	N	TPD	N	TC	N
Reverse-pattern	3	true	3	true	2	false	3	true	1
				false	1			false	2

Table 11: Adult Performance on NPDF, ES2, TPD and TC

However, unlike the child participants the adults did not clearly show discernable response patterns on the other conditions. It was not the case that adults who display the Reverse-pattern then also consistently performed non-target-like on the other conditions.

Another group of six adults showed the Ambiguity-pattern. These adults tended to judge all test sentences to be true. In addition, 19 adults performed target-like. As expected, these adults generally accepted the ES-conditions and rejected the NPD-conditions. The full results for these two groups are presented in appendix 7.

5.6 Discussion

The Reverse-pattern does not occur with all universal quantifiers. In the previous chapter a significant difference between *ieder* ('each/every') and *alle* ('all') was found. That is, the Reverse-pattern was observed to a high degree when children were presented with double-object datives containing the distributive universal quantifier *ieder*, but not with *alle*. This distinction supported the view that children's interpretation of distributivity was the source of the Reverse-pattern. In this chapter, we first investigated the psychological reality of Tunstall's (1998) Event-Distributivity condition which stated that universal quantifiers like *every* are only felicitous in situations with an at least partially distributive event structure. The results of a picture-selection task with Dutch adults cast doubt on the validity of this account, but did suggest the possibility that perhaps the most basic interpretation of quantifiers of the *every*-type is an interpretation which requires a fully distributive event structure. This formed the basis for introducing two versions of the Prototypical Distributivity Hypothesis, a strong version and a weak version, as presented in (26) and (27) below:

(26) **The Weak Prototypical Distributivity Hypothesis**

Distributive universal quantifiers force a prototypically distributive event structure, i.e. an event structure in which every element in the restrictor set of the universal quantifier is associated with a distinct subevent. However, adults can deviate from this prototypical interpretation, whereas children cannot.

(27) **The Strong Prototypical Distributivity Hypothesis:**

Distributive universal quantifiers force a prototypically distributive event structure, i.e. an event structure in which every element in the restrictor set of the universal quantifier is associated with a distinct subevent. In addition, these subevents need to be unique. However, adults can deviate from this prototypical interpretation, whereas children cannot.

The above hypotheses require every element in the domain of the universal quantifier to be associated with a distinct subevent. This is the only requirement of the Weak Prototypical Distributivity Hypothesis, while the Strong Prototypical Distributivity Hypothesis adds the requirement that each subevent needs to be unique and non-overlapping.

The predictions of these hypotheses were put to test in a Truth-Value Judgment task in which the by now familiar double-object constructions were presented in a variety of situations, some of which satisfied prototypical distributivity and some of which did not. The results of this experiment allow us to draw several conclusions. First of all, the results on the DOA and DAO conditions (i.e. the double object condition presented in either a canonical ONE>ALL event or a canonical ALL>ONE event) robustly replicated the results of the child participants in previous experiments (see chapter 2). Just like in previous experiments, the child participants in this experiment rejected the DOA condition about 60 percent of the time (63.4 percent) and accepted DAO close to 80 percent of the time (79.5 percent). More than half of the children (56.1 percent) unambiguously showed the Reverse-pattern.

When children were presented with an event which lies somewhere in between the ONE>ALL and the ALL>ONE event, as is the case in the NPDE condition (Non Prototypical Distributivity Extra), they tended to reject the test sentences (80.4 percent of the trials). That is, when a sentence

like (28) was presented in a situation in which one giraffe got one apple, one giraffe got two and one giraffe got something else, children generally rejected the test sentence. Every child who showed the Reverse-pattern also rejected the NPDE condition, as can be seen in table 6 in section 5.5.3.2. Meanwhile, adults tended to reject this condition. This result was as predicted, given that the Scope Freezing Constraint blocks any interpretation other than the interpretation where a single giraffe gets every apple.

- (28) *Het meisje heeft een giraffe elke appel gevoerd.*
 the girl has a giraffe every apple fed
 ‘The girl fed a giraffe every apple.’

The above result for the NPDE condition suggests that the Prototypical Distributivity Hypothesis may be on the right track. Children may indeed require each object in the restrictor set of *elke* (‘every’) to be associated with a distinct subevent in which the predicate applies to that object. To test whether this could be the case, another condition was included in the experiment namely NPDF (Non-Prototypical Distributivity Full). This condition presented a sentence like (28) above in a situation in which every giraffe got at least one apple (one giraffe in fact got two). In this case there was no character that did not receive any apple, but there was also no strict one-to-one correspondence between the characters/recipients and the objects. The results showed that children tended to accept test sentences in this condition 85.3 percent of the trials. Nearly every child who showed the Reverse-pattern also accepted this condition (only one child rejected this condition on one of its trials). Adults rejected this test condition, which was expected since any situation other than the ONE>ALL-type event would violate the Scope Freezing constraint. Whereas the adult results were in conformity with the predictions, the child results did not, as both versions of the Prototypical Distributivity Hypothesis predicted ‘no’-responses here.

In addition, the Weak Version of the Prototypical Distributivity Hypothesis predicted that when the sub-events in the ONE>ALL situation were spatio-temporally separated, children would perform significantly more targetlike. To test this prediction, two new conditions were included: ES1 in which subevents were separated both in the pictures and the story, and ES2 in which the events were only separated in the story, but not in the accompanying picture. However, the results showed that neither modification had any effect. Children still rejected test sentences in the ONE>ALL event between 60 and 80 percent of the time. There was again near-complete overlap between the children who showed the Reverse-pattern on DOA and DAO, and children who rejected the test sentences in the ES-

conditions. Adults performed target-like and tended to accept the ES conditions. Whereas the results on the ES-conditions are consistent with the Strong Prototypical Distributivity Hypothesis, they are not consistent with Weak Prototypical Distributivity.

With respect to TPD and TC, we see that children tend to accept both conditions. Adults, on the other hand reject both nearly 55 percent of the time. Recall that these conditions tested simple transitive sentences with a universally quantified subject and an indefinite object in either a situation in which there was partial event-distributivity (TPD) or a situation in which there was no event-distributivity (e.g. the collective TC condition). The results for both adults and children are puzzling. The assumption made in section 5.5 was that the basic interpretation of a distributive universal quantifier requires prototypical distributivity, and that all other interpretations are derived from that basic interpretation when required. We further assumed that adults are able to do this, but children are not. On this basis we would expect adults to be able to deviate from Prototypical Distributivity in order to accept the test statements of the TPD and TC condition, whereas children should always reject the test sentences. In fact, the results are nearly the opposite. Children tend to accept the test statements, while adults reject them more than half the time.

Many adults seemed to find the use of a distributive universal quantifier in these sentences inappropriate and told the experimenter that in their view there was a better way of expressing the same proposition, namely by using the universal quantifier *alle*. This may explain the adult results on the TPD and TC conditions to some degree. If adults considered the sentence to be infelicitous, then they may have led them to judge the test sentences to be false. Alternatively, perhaps those adults who judge the test sentences to be false just fail to accommodate the ‘violations’ of prototypical distributivity. When presented with a double-object construction in a ONE>ALL event, the Frozen Scope Constraint forces adults to accommodate a non-prototypically distributive situation. In the case of TPD and TC there is no such constraint that forces this. Some adults may accommodate because this would allow them to judge the test sentences to be true. Other adults may not do this and judge the test sentences to be false.

Whereas the only adult results that are not consistent with the predictions presented in table 8 can be explained in terms of a failure to accommodate, this does not work for children. Children were not expected to accommodate at all. Furthermore, even if children did, then it is unclear why they would accommodate in certain conditions, e.g. NPDF, TPD and TC, but not in others. The main question to be answered now is why children accept DAO, NPDF, TPD and TC, while they reject DOA, NPDE, ES1 and ES2. There is actually a property which distinguishes these two sets of conditions.

In the set consisting of DAO NPDE, TPD and TC there were two sets which were exhaustively linked. Every element in the restriction set of the universal quantifier was linked to an element in another set, even though not all these ‘linkings’ represented a distinct subevent. For instance, in the NPDE condition a set of giraffes and a set of apples would be linked in such a way that every apple was linked to a giraffe, and every giraffe was linked to at least one apple. The NPDE, ES1, ES2 and DOA conditions did not share this property of FULL SET LINKING. In the NPDE condition a set of giraffes and a set of apples would be linked, but while every apple was linked to a giraffe not all giraffes were linked to an apple. There was thus an ‘extra’ character present who was not involved in the event described by the predicate, but could plausibly have been involved. It thus seems as though children accept deviations from prototypical distributivity, as long as the two object sets under consideration are fully linked. We can define Full Set Linking as the requirement that two sets under consideration are exhaustively linked, and that therefore each element in set 1 is linked to at least one element in set 2, and vice versa. If they are not, as is the case in DOA, NPDE and ES, children reject the test sentences.

To summarize the child results, the Prototypical Distributivity Hypotheses as stated in (26) and (27) do not seem to hold. Weak Prototypical Distributivity predicted acceptance of ES1 and rejection of NPDE, NPDE, TC and TPD. However, in this experiment children rejected ES1, but accepted NPDE, TC and TPD. Only the prediction for NPDE was borne out. Strong Prototypical Distributivity predicted rejection of ES1, TC, TPD, NPDE and NPDE. However, children accept TC, TPD and NPDE. The question now is how to account for these results. Do we reject Prototypical Distributivity or do we retain Prototypical Distributivity and expand it by including a requirement for ‘Full Set Linking’? In the next chapter we will propose an account which retains Prototypical Distributivity and derives Full Set Linking from properties of the interpretation strategy that children use in order to determine whether a context satisfies Prototypical Distributivity.

Chapter 6

An Account

In chapter 5 we put forward the hypothesis that for both children and adults the initial interpretation of a distributive universal quantifier is an interpretation which forces a prototypically distributive event structure. We hypothesized that, unlike adults, children are not able to accommodate deviations from prototypical distributivity, causing them to judge test sentences containing distributive universal quantification to be false of situations whose event structure does not satisfy the prototypical distributivity requirement. However, this prediction was not borne out. It turned out that all situations in which children accepted test sentences also had an additional property, namely they displayed Full Set Linking. That is, in all these situations there was an exhaustive (but not necessarily one-to-one) linking between the set of characters (recipients) and the set of objects. By contrast, none of the situations in which children rejected test sentences had this property. In this chapter we will put forward a new account of children's non-target-like interpretation of dative sentences in which Scope Freezing applies. This account incorporates prototypical distributivity as well as the Full Set Linking requirement. However, before turning to this account, let us first summarize the results of the last five chapters and make an inventory of what we have learned about children's non-target-like performance.

6.1 The Reverse-pattern

In chapters 1 and 2 we introduced SCOPE FREEZING or the FROZEN SCOPE CONSTRAINT (Larson, 1990; Bruening, 2001). This scope constraint prohibits wide scope of the direct object over the indirect object in double-object constructions, and thus ensures that a sentence like (1) can only mean that a certain girl was sold every apple by the man. It cannot mean that every apple was sold to a (different) girl.

- (1) The man sold a girl every apple.

In chapter 2 we found that when English- and Dutch-speaking preschool children were presented with sentences like (1) in a Truth-Value Judgment task (Su and Crain, 2000; Su 2001a,b, and the experiment in chapter 2), many of them showed a performance pattern which we named the REVERSE-PATTERN. That is, they rejected the interpretation that adults allow,

and accepted the (distributive) interpretation that adults cannot derive. We also showed that this Reverse-pattern could not be explained through a non-targetlike scope assignment. The pattern could also not be linked to incomplete acquisition of the structure of the double-object dative (see 2.5.2). Furthermore, it was argued that the Reverse-pattern was not simply an instance of Exhaustive Pairing (see section 2.5.3), though we will come back to the link between the Reverse-pattern and Exhaustive Pairing later on.

6.2 *The Indefinite*

In order to explain children's non-targetlike performance, Su (2001b) put forward the Lexical Factor Hypothesis, which in chapter 3 we modified to (2):

- (2) Modified Lexical Factor Hypothesis: The difference between the performance of the English and Chinese-speaking children is caused by a lexical idiosyncrasy between the two languages. At an early stage of development Chinese-speaking children treat *yi-ge* as meaning something like 'exactly one'. At an early stage of development English-speaking children do not allow *a/an* to have a meaning that overlaps with the meaning of the numeral *one*. That is, they do not allow the DP headed by *a/an* to refer to a set whose cardinality is 'exactly one'.

One prediction of the Modified Lexical Factor Hypothesis was that the Reverse-pattern should only be observed when participants were presented with test sentences containing the indefinite article *a/an*, and not with sentences containing the singular indefinite determiner *some*, or the numeral *one*. However, we showed that English-speaking children in fact did show the Reverse-pattern when presented with double-object constructions in which the indefinite article *a/an* was replaced by the indefinite determiner *some* (singular). In addition, when presented with sentences containing the numeral *one* English-speaking (but not Dutch-speaking) children still showed the Reverse-pattern. The results of the English children thus provide evidence against the Modified Lexical Factor Hypothesis. The results of the Dutch children do not, though in chapter 3 we argued that their performance can be explained with reference to specific properties of the Dutch lexical item that functions as the numeral.

In addition we tested the validity of the Singleton Restriction Hypothesis, which argued that children often fail to restrict indefinites to a singleton domain when the discourse context makes salient a set of

characters ($N > 1$) whose members could all plausibly form part of the domain of that indefinite. If children indeed have problems restricting an indefinite to a single individual from a larger set, then they should experience these problems in all cases in which they are presented with a discourse context in which multiple similar individuals are made salient and a test sentence in which only a source-set interpretation of the indefinite would lead to a true proposition. In an experiment we showed that children do not have problems restricting indefinites to a singleton domain, and in fact do not seem to have problems interpreting indefinites correctly in sentences that do not contain a universal quantifier.

6.3 Universal Quantification

The results of the experiments discussed in chapter three suggested that it is not so much the presence of the indefinite article, but rather the presence of the universal quantifier which leads children to interpret the test sentences differently from adults. Chapter 4 therefore asked whether non-targetlike performance is limited to constructions containing universal quantifiers, or occurs with a variety of quantifiers which are in some way similar to them, like numerals (other than *one*). We proposed the Distributivity Hypothesis (following Drozd and Van Loosbroek, 2006) which states that children judge test sentences to be false because of a mismatch between the distributivity features on certain universal quantifiers and their interpretation of the nature of the event-structure of the context in which the sentence containing the universal quantifier is presented. That is, if a context does not unambiguously support a distributive interpretation, children reject test sentences containing a distributive universal quantifier because in their view the context and the test sentence do not match. This predicts that the Reverse-pattern should only occur when the universal quantifier is obligatorily distributive and thus carries distributivity features. The results of two experiments showed (i) that the Reverse-pattern is indeed limited to universal quantifiers, and (ii) that the Reverse-pattern is limited to a subset of universal quantifiers, namely distributive universal quantifiers. It does not occur with non-obligatorily distributive universal quantifiers like *all*. We therefore turned our attention to distributivity.

6.4 Distributivity

After introducing the notion of events and event structure in the definition of distributivity, we attempted to determine what adults and children would consider to be a distributive event structure. We therefore introduced Tunstall's (1998) Event-Distributivity Account which argued that

universal quantifiers like *every* require an event structure that is at least partially distributive. However, we further argued that this Event-Distributivity Condition is not inviolable, and that adults are able to deviate from this condition to a certain degree (as they must in order to accept a sentence like *The bear gave a fox every cake* in a ONE>ALL event). However, despite this possibility of accommodation, adults should always prefer a situation which satisfies the Event-Distributivity Condition over a situation which does not.

The results of a picture selection task showed that adults indeed seemed to prefer a situation which was partially distributive (and thus satisfied Event-Distributivity) over a situation which did not satisfy Event-Distributivity (e.g. a situation containing only a single subevent) in most cases (except the condition in which the universal quantifier co-occurred with a proper noun). However, follow-up questions indicated most adults considered both the partially distributive (2 subevents) and the non-distributive situation (one subevent) defective and in (nearly) all cases indicated that they would have preferred a fully distributive event structure, e.g. an event structure in which every individual element in the restrictor set of the universal quantifiers is associated with a spatio-temporally distinct subevent. It seems that for adults a sentence containing *every* (or rather Dutch *ieder* and *elk*) immediately calls up an image in which there is PROTOTYPICAL DISTRIBUTIVITY, and not just partial distributivity.

The above observation formed the basis of a set of Prototypical Distributivity Hypotheses, as in (3) and (4) below:

- (3) **The Weak Prototypical Distributivity Hypothesis**
Distributive universal quantifiers force a prototypically distributive event structure, i.e. an event structure in which every element in the restrictor set of the universal quantifier is associated with a distinct subevent. Whereas adults can deviate from this prototypical interpretation, children cannot.
- (4) **The Strong Prototypical Distributivity Hypothesis**
Distributive universal quantifiers force a prototypically distributive event structure, i.e. an event structure in which every element in the restrictor set of the universal quantifier is associated with a distinct subevent. *In addition, these subevents need to be unique.* Whereas adults can deviate from this prototypical interpretation, children cannot.

To test these hypotheses we presented children with a variety of different event structures which either did or did not satisfy prototypical distributivity. The results showed that neither of the prototypical distributivity hypotheses could by itself explain children's performance. However, in all of the contexts in which children judged test sentences to be true there would be a full (though not necessarily one-to-one) linking of the set of possible recipients and a set of objects. This property was not shared by any of the contexts in which children rejected test sentences. We named this property 'Full Set Linking'.

In the next section we will propose an account which retains Prototypical Distributivity, but also incorporates Full Set Linking.

6.5 The Account

6.5.1 Prototypical Distributivity and Full Set Linking

The results of the Truth-Value Judgment experiment discussed in chapter 5 showed that children's non-targetlike performance is not fully captured by the hypothesis that children are unable to deviate from prototypically distributive event structure. We have shown that children do in fact deviate from prototypical distributivity. However, all of the situations in which children accepted the target sentences also had an additional property, namely Full Set Linking. That is, in all cases the set of recipients and the set of objects are exhaustively linked, though the linking between the two sets is not necessarily one-to-one.

In this section we will propose an overarching account of children's non-targetlike performance, but before we do that we need to be clear about whether we need to incorporate both Prototypical Distributivity and Full Set Linking, or whether we can disqualify the former. As stated above, all of the situations in which children accept test sentences are situations in which Full Set Linking holds. We therefore need to ask ourselves whether we could explain children's non-targetlike performance by only positing a requirement for Full Set Linking. However, recall that the reason why we related children's non-targetlike performance to (prototypical) distributivity was the fact that the Reverse-pattern disappears when children are presented with non-obligatorily distributive quantifiers. In chapter 4 we observed that while the Reverse-pattern occurs with the Dutch distributive universal quantifiers *elk* ('each/every') and *ieder* ('each/every'), children did not perform this way when they were presented with the 'collective' universal quantifier *alle* ('all') or the numeral *drie* ('three') in exactly the same situation types. If Full Set Linking were the only factor that determines children's performance, then the Reverse-pattern should have been observed with all of the

quantifiers that were tested. In other words, the results reported in chapter 4 force us to assume that Full Set Linking only plays a role when children are evaluating sentences containing distributive universal quantifiers. In addition, the results of the picture selection task in chapter 5 strongly suggest that (for adults) distributive universal quantifiers are associated with prototypically distributive event structures. Therefore, we will retain Prototypical Distributivity.

Since we will adhere to Prototypical Distributivity, we need to determine which of the two definitions of Prototypical Distributivity we will use. In chapter 5 we introduced two distinct Prototypical Distributivity Hypotheses. According to the weak version, each element in the restrictor set of the distributive universal quantifier needs to be associated with a spatio-temporally distinct subevent, whereas according to the strong version each element in the restrictor set of the distributive universal quantifier needs to be associated with a spatio-temporally distinct subevent *and the relevant subevents (and their participants) need to be unique*. We will here assume the weak version, as this definition of Prototypical Distributivity is more consistent with standard definitions of distributivity. That is, this version of prototypical distributivity only places demands on the elements that are members of the restrictor set of the universal quantifier and their relation to a set of subevents, and not on the subevents themselves and the other participants of those subevents. This implies that when sentence (5) is interpreted with wide scope of the universal quantifier in subject position, this sentence is true when every boy danced with a different girl, when every boy danced with the same girl, and in situations in which there are other boy-girl combinations, as long as each boy is associated with a different subevent in which he is dancing with a girl.

(5) Every boy danced with a girl.

As such, the weak version of the prototypical distributivity hypothesis straightforwardly retains the entailment relation between the surface scope interpretation and the inverse scope interpretation. That is, under this definition wide scope of the indefinite entails wide scope of the universal quantifier. All situations in which wide scope of the indefinite is true (a specific girl dances with each of the boys) are also situations in which wide scope of the universal quantifier is true. This entailment property is not easily derived in the strong version of prototypical distributivity, as according to this version the sentence in (5) can only be used to refer to a situation in which every boy danced with a distinct girl. Of course we argued in chapter 5 that adults are able to accommodate situations in which (strong)

prototypical distributivity does not hold, so there are ways to derive this entailment relation. However, for now we will use the weak version of prototypical distributivity which straightforwardly derives it.¹⁰⁸ In addition, as we will see below, the uniqueness or exclusivity requirement of the strong prototypical distributivity hypothesis can actually be captured in another way. That is, when there is a one-to-one correspondence of two sets this facilitates interpretation by making an economic interpretation strategy available.

In this section we will argue (i) that both children and adults require prototypical distributivity, (ii) both children and adults often use a short-cut when determining whether prototypical distributivity holds, namely they evaluate the end-state, (iii) when this short-cut interpretation does not produce results adults change their interpretation strategy and check whether each element in the restrictor set is associated with a distinct event, but (iv) children continue to evaluate the end-state, and (v) it is this strategy that children use that induces the requirement for Full Set Linking.

As soon as children (and adults) are presented with a universal quantifier, they start to evaluate whether the situation in which the sentence is presented has a prototypically distributive event structure. This ideal prototypical event structure is an event structure in which every object in the restrictor set is associated with a spatio-temporally distinct subevent. The basic event structure that a distributive universal quantifier requires thus closely corresponds to the interpretation that is forced in ALL>ONE events.¹⁰⁹ For convenience this event structure is again presented in (13) below. The arrows indicate *being-given-to* events.

¹⁰⁸ Another advantage of choosing the weak version of the Prototypical Distributivity Hypothesis is that while the strong version extra stipulations in order to exempt the subjects of double-object constructions from the uniqueness requirement (see section 5.5), the weak version does not require any additional stipulations.

¹⁰⁹ Although according to the definition of prototypical distributivity assumed here, situations in which there are distinct subevents for the elements in the restrictor set of the universal quantifier but not a distinct recipient for each subevent also satisfy prototypical distributivity (e.g. the ES1-condition).

(6)

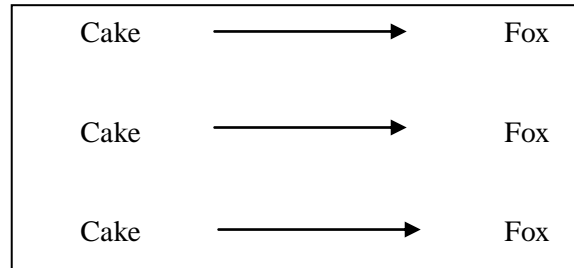

In chapter 2 through 5 we have seen that children nearly always accept test sentences in this type of event, despite the fact that the Frozen Scope Constraint should block this interpretation.

In order to determine whether event-distributivity holds in a situation like 0, it is not necessary to check for each cake individually whether it is associated with a distinct subevent, but we could check whether the two sets of participants match up exactly. In other words, we do not need to check whether each element of the restrictor set is associated with a certain event, but we evaluate the end-state and see whether there is a one-to-one match between the two sets. However this shortcut to interpretation is not always available. An example of a situation in which this is not the case is a situation in which every cake is given to a single fox in three spatio-temporally distinct events (a situation that does satisfy prototypical distributivity). We will assume that when adults are presented with such a situation, they first attempt the short-cut. When this does not work, they backtrack and revise their interpretation, and instead check whether each element of the restrictor set is associated with a distinct subevent. However, there is some leeway in this second interpretation strategy, as adults can often accommodate situations which strictly speaking do not satisfy prototypical event-distributivity. To illustrate this, consider the two situations below:

(7)

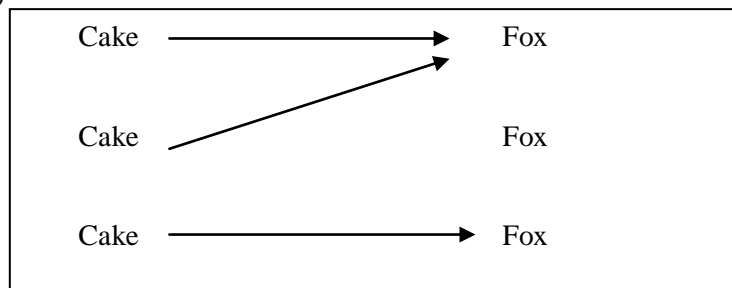

(8)

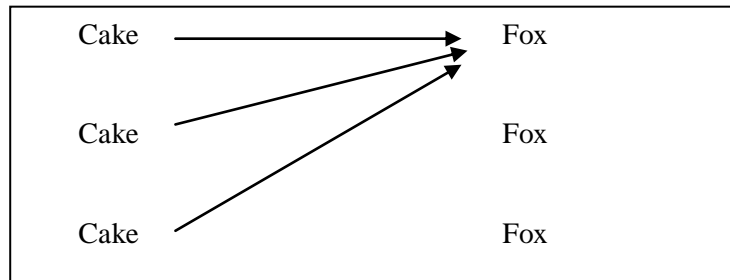

In the partially distributive situation in (7) and in the non-distributive situation in (8) each element in the restrictor set is a participant of a certain subevent, but the subevents are not distinct and the event structure is therefore not (fully) distributive. That is, in the partially distributive event structure one of the cakes is associated with a distinct *cake-giving* subevent, while the other two cakes are participants of a single *cake-giving* subevent. In the non-distributive event structure all cakes are participants in the same *giving*-event. Crucially, in both of the above cases each cake is the participant in SOME cake-giving event, the only aspect of the Prototypical Distributivity Condition that does not hold is the requirement for these subevents to be distinct. We argued in chapter 5 that there are a variety of reasons why adults may deviate from prototypical distributivity. Sometimes scope constraints force adults to reject situations in which prototypical distributivity does hold in favour of a situation in which it does not. The Frozen Scope Constraint, for instance, forces an interpretation in which a single character gets all of the objects, which does not necessarily correspond to a prototypically distributive event structure. In this case the demands of the Frozen Scope Constraint are placed above the demands for prototypical distributivity and the situation is accommodated. In addition, we have seen that in cases in which a certain sentence can only be a true description of a situation when a non-prototypically distributive event structure is accommodated, this is what many adults do (as was the case in the picture-selection task and for half the adults on the TPD and TC conditions in the Truth-Value Judgment task in chapter 5). For now we will assume that when adults need to deviate from prototypical distributivity and when a weaker requirement holds (e.g. each element in the restrictor set of the universal quantifier has a certain property and is the participant of a certain eventuality), they often consider this to be ‘close enough’. That is, in those cases adults can mentally create an event structure in which the subevents would be distinct and that prototypical distributivity would be met, despite the fact that this is not explicitly the case.

Above we have given an account of how adults interpret distributive universal quantifiers and how they can accommodate deviations from prototypical distributivity. We will now turn to the question of children's interpretation of the same quantifiers. We will argue that children like adults use a short-cut to determine whether a situation like 0 satisfies prototypical distributivity, but that unlike adults children do not change their verification strategy when the context does not support this short-cut. This means that, in all cases, children first check whether the elements in both of the sets match up. Of course the next question is why children continue to use the shortcut to quantifier interpretation to evaluate discourse situations and why they do not switch to a targetlike way of evaluating the situations when there is no exact one-to-one matching between the two sets. We could argue that the 'short-cut' presents the most economic way of processing a context and that it thus requires fewer processing resources. However, just positing that it is a simpler processing strategy is a rather unsatisfactory explanation. A second possibility is that children do not revise their interpretation strategy because they cannot backtrack. Literature on sentence processing by preschool children has shown that they often have trouble revising earlier commitments (see Trueswell et al 1999). A third possibility is that children have not acquired the target-like processing strategy yet, and are thus forced to rely on the 'short-cut'. Although the question then becomes how and when they can acquire this strategy. If children have knowledge of the target-like strategy all along, then the question is when (and how) children start using the evaluation strategy that is available to adults and stop relying on the end state. At this point we do not have good answers to these questions, and we will have to rely on future research to shed more light on them.

We will argue that it is the short-cut interpretation strategy that children use that induces a requirement for Full Set Linking. A situation which satisfies Prototypical Distributivity and whose distributivity can be unambiguously determined by using the short-cut interpretation strategy is a context in which there is a one-to-one linking between two sets (see (6)). Recall that children were presented with two kinds of situations which deviated from this ideal event-structure. In one type of situation the two sets do match up, but the members of the two sets are not in one-to-one correspondence (e.g. one fox gets two cakes, whereas two others only get one). The second type of context also does not see the two sets in one-to-one correspondence, but in addition one of the elements is not linked to any other element. Whereas children accept test sentences in the former type of situation, they reject them in the latter. The question now is why for children a situation in which one element is 'left over' constitutes such a strong

violation. We will argue that this relates to the nature of the short-cut interpretation. When children are interpreting distributive universal quantification, they check whether each element in one set corresponds to an element in the other set and vice versa. When matching up the two sets any element that is left over is salient. If they interpreted universal quantification the target-like way, then at this point they would have backtracked and changed interpretation strategies. However, since they seem unable to do this, any element that is left over creates a problem. When the two sets match up, but one element in one set is associated with two elements in the other set, this deviates from the ideal one-to-one pattern, but it at least avoids having one element left over. It merely spoils the symmetry, and children can accommodate this. In sum, a situation in which a single element is not linked up to one or more elements in the other set is considered a strong violation. For children a deviation in which all of the elements of both the distributive key and the distributive share are involved (in which there is thus Full Set Linking) presents a smaller violation than when a single element in either set is left over.

In positing the above account, we have almost inadvertently arrived at an account which predicts Exhaustive Pairing. Recall that Exhaustive Pairing is the phenomenon where children judge sentences like *Every boy is riding an elephant* to be false of situations in which each boy is riding an elephant but one elephant does not have a rider. If children, when presented with a distributive universal quantifier and a situation in which there are two sets which stand in a certain relation, attempt to evaluate the sentences by matching up the two sets, then the single elephant which does not have a rider would constitute a violation. However, while in this dissertation we have found that children only performed non-targetlike with distributive universal quantifiers, Exhaustive Pairing is known to occur with all universal quantifiers. The question of why Exhaustive Pairing occurs with *all* as well and the question whether the Reverse-pattern and the Exhaustive Pairing error are really related must be left for future research.¹¹⁰

To summarize, above we have argued that for both children and adults distributive universal quantifiers require a prototypically distributive event structure. However, children and adults differ in the way they evaluate whether a situation satisfies prototypical distributivity. Children use a short-cut which is also available to adults, that is, they look for a one-to-one matching between two sets. However, unlike adults, children use this short-cut all the time. It is the use of this strategy which favours situations in

¹¹⁰ Another interesting question is why the Reverse-pattern seems to occur more often and persist longer than Exhaustive Pairing-errors, see Philip (1996) and section 2.5.3.

which there is Full Set Linking over situations in which one or more objects in the set of recipients are not involved.

In this section we have presented an account of children's non-targetlike performance, but we have put aside the fact that in the double-object constructions we have been examining a scope constraint should be active. We have argued that this scope constraint is what often forces adults to reject test sentences in which prototypical distributivity holds, and accept them in situations which deviate from the ideal event structure. However, we have not determined whether children have any knowledge of the scope constraint.

6.5.2 Frozen Scope

In the preceding section we have argued that children's performance on test sentences containing distributive universal quantification is non-targetlike because they continually use an evaluation strategy that adults only sometimes use. This interpretation strategy is what leads them to accept test sentences in situations in which prototypical distributivity is not met, but Full Set Linking is. However, the construction we have focused on in this dissertation, e.g. the double-object construction, is a construction in which scope interaction is restricted. For adults the Frozen Scope Constraint applies, a constraint which blocks inverse scope of the direct object quantifier and thus forces a wide scope interpretation of the indefinite indirect object. In chapter 5 we argued that this constraint forces adults to deviate from prototypical distributivity. It forces adults to accommodate a situation in which prototypical distributivity does not hold, but the weaker requirement of object-distributivity does. However, a question we have not yet answered is whether children have access to the Frozen Scope Constraint as well. We know that children do not seem to apply the constraint, but is this because they have not acquired it or because, for children, Prototypical Distributivity and the evaluation strategy they use take precedence over the Frozen Scope Constraint?

In chapter 1 we discussed two possible accounts of the Frozen Scope Constraint. The first was Bruening's syntactic account (Bruening, 2001), which argued that Scope Freezing is a by-product of a general condition that applies to (covert) movement (e.g. Shortest). To be precise, Bruening argued that Quantifier Raising cannot reorder the two objects, meaning that at no point in the derivation is the direct object able to c-command and thus take scope over the indirect object. If Scope Freezing indeed derives from such a basic condition on movement operations, then this implies that children who have acquired the intricacies of syntactic movement should

also have knowledge of Scope Freezing. In chapter 1 we argued that since children have acquired most of the intricacies of both overt and covert movement by the age of five and since they in addition have knowledge of the structure of the double-object constructions and the relevant features of the lexical items involved (i.e. the universal quantifier and the indefinite article) preschool children should show knowledge of the Reverse-pattern. In chapter 1 we also introduced Goldberg's (2006) account, which related scope freezing to the status of the indirect object as a secondary topic. Topics present given material with reference to which the new information in the sentence is evaluated. According to Goldberg topicality is highly correlated with wide scope. Since the indirect object in a double-object construction is more topical than the direct object, the indirect object tends to take wide scope. This account predicts that Scope Freezing is acquired when children have acquired the relevant aspects of information structure. Most features of information structure are acquired late (e.g. the correct use of pronouns, definite markers and even the ordering of old-new information, see chapter 1 section 1.4.2), and thus Scope Freezing will probably be acquired late as well.

However, the results of the experiments showed that preschool children do not have knowledge of Scope Freezing, as generally less than 10 percent of the children interpret double-object constructions in a target-like way. There are two options available to us. One possibility is that children in principle have access to the scope constraint, but fail to apply it because prototypical distributivity and the use of a short-cut interpretation strategy in some way block the application of this constraint. A second possibility is that children do not have access to Scope Freezing yet, and that the results of the experiments thus present additional evidence against the syntactic account of Scope Freezing. We will take the second option: Dutch and English preschool children have not acquired Scope Freezing. This possibility is consistent with the Information-Structural approach to Scope Freezing which we have (implicitly) assumed in this study. That is, children have not acquired Scope Freezing, because they have not yet acquired the strong link between the indirect object position in a double-object construction and its secondary topic status. This link may be acquired late, and hence Scope Freezing may be acquired late as well.

One advantage of linking Scope Freezing to Information Structure and topicality is that it gives us the opportunity to unify the late acquisition observed for a variety of different scope constraints. If we limit ourselves to Dutch, then this applies to sentences containing scrambled object indefinites (Krämer, 2000), transitive sentences with an indefinite subject (Philip, 2005; Hendriks *et al.*, to appear), as well as the double-object constructions with an indefinite indirect object discussed in this dissertation. In all these cases the

indefinite takes wide scope, and inverse scope of another scope-taking expression (whether it is a negative operator or a universal quantifier) is blocked. All of these constraints could be argued to have an information-structural source. Scrambling is a movement operation which often seems conditioned by information-structural considerations. Therefore if a direct object scrambles to a position to the left of negation or different types of scope-taking adverbs, this could be because in that position they are identified as (secondary) topics and thus take wide scope. In addition, subjects are generally interpreted as primary topics and thus generally take widest scope. It could be that in a language like Dutch the subject position is more strongly associated with topicality than in other languages.¹¹¹ In this case inverse scope in Dutch would be less accessible than it is in certain other languages, thus causing the Specificity Constraint in sentences with indefinite subjects. We know that the Specificity Constraint and the targetlike interpretation of scrambled direct object indefinites are acquired relatively late. According to Philip (2005), many 12-year olds have not acquired the Specificity Constraint yet. In addition, non-targetlike performance on sentences containing scrambled indefinite objects can also persist up to about age 12 (Unsworth, 2005). In addition, we know that six-year olds have not acquired Scope Freezing yet, but we do not yet know exactly when they do acquire it. Perhaps the reason all these constraints are acquired at a relatively late age is because they are all constraints which crucially rely on information structure and topicality.

To summarize, when adults are presented with double-object constructions they are immediately led to a wide scope interpretation of the indefinite because they strongly associate the indirect object in a double-object construction with topicality. As a consequence, adults are often forced to accommodate situations in which prototypical distributivity does not hold, and reject situations in which prototypical distributivity does hold. However, most children will not have acquired the (obligatory) topic-status of indirect objects and thus do not have a strong preference for interpreting the indirect object with wide scope. In the absence of knowledge of Scope Freezing, the requirements of the distributive universal quantifiers with regard to event structure and the interpretation procedures children use in order to determine whether these requirements are met determine their responses and thus cause the Reverse-pattern.

¹¹¹ See Philip (2005) for an account of the Specificity Constraint which relies on topic-marking.

6.5.3 Conclusion

In the general introduction to this dissertation we asked why children assign non-targetlike interpretations to sentences containing quantified expressions. In the chapters that followed we have attempted to answer this question for a single construction, namely a double-object construction of the form *The bear gave a fox every cake*, and a single non-targetlike performance pattern, namely the Reverse-pattern. After first examining when the Reverse-pattern is observed and investigating the role of Prototypical Distributivity we have arrived at an account which relates children's non-targetlike performance to them (i) not having acquired the Frozen Scope Constraint yet, and (ii) continuing to use an interpretation strategy which for adults is only a short-cut to evaluating quantifier interpretation.

References

- Abush, D., 1994, 'The scope of indefinites', *Natural Language Semantics* 2, 83-135.
- Aoun, J. and Y-h, 1989, 'Constituency and scope', *Linguistic Inquiry* 20, 141-172.
- Aoun, J. and Y-h. Li, 1993, *The syntax of scope*, Cambridge (MA): MIT Press.
- Bach, E., 1986, 'The algebra of events', *Linguistics and Philosophy* 9, 5-16.
- Barrs, A. and H. Lasnik, 1986, 'A note on anaphora in double-object constructions', *Linguistic Inquiry* 17, 347-354.
- Becker, M., 1999, 'The *some* indefinites', in G. Storto (ed.) *Syntax at Sunset 2: UCLA Working Papers in Linguistics* 3.
- Beghelli, F. and T. Stowel, 1997, 'Distributivity and negation: the syntax of *each* and *every*', in A. Szabolcsi (ed.) *Ways of Scope Taking*, Dordrecht: Kluwer, 71-109.
- Bennett, M., 1974, *Some Extensions of a Montague Fragment of English*, Doctoral Dissertation, University of California Los Angeles.
- Bergsma-Klein, W., 1996, *Specificity in Child Dutch: An experimental study*, Unpublished MA-thesis, Utrecht University.
- Boeck, K.J., H. Loebell and R. Morey, 1992, 'From conceptual roles to structural relations: bridging the syntactic cleft', *Psychological Review* 99, 150-171.
- Bornstein, M.H., 1985, 'On the development of color naming in young children: data and theory', *Brain and Language* 26, 72-93.
- Brisson, C.M., 1998, *Distributivity, Maximality and Floating Quantifiers*, Doctoral Dissertation, Rutgers University.
- Brooks, P.J. and M.D.S. Braine, 1996, 'What do children know about the universal quantifiers *all* and *each*', *Cognition* 60.3, 235-268.
- Brooks, P., M. Braine, G. Jia and da Graca Dias, 2001, 'Early representations of *all*, *each* and their counterparts in Mandarin Chinese and Portuguese' in M. Bowerman and S. Levinson (eds.), *Language Acquisition and Conceptual Development*, Cambridge: Cambridge University Press, 316-339.
- Brooks, P.J. and I. Sekerina, 2005/2006, 'Shortcuts to quantifier interpretation in children and adults', *Language Acquisition* 13.3, 177-206.
- Bruening, D., 2001, 'QR obeys superiority: frozen scope and ACD', *Linguistic Inquiry* 32.2, 233-273.
- Büring, D., 1997, 'The great scope inversion conspiracy', *Linguistics and Philosophy* 20, 175-194.

- Carlson, G., 1977, *Reference to kinds in English*, Doctoral Dissertation, University of Massachusetts, Amherst, 320-325.
- Carlson, G., 1981, 'Distribution of free choice *any*', *CLS 17*, 8-23.
- Chafe, W.L., 1987, 'Cognitive constraints on information flow', in R. Tomlin (ed.), *Coherence and Grounding in Discourse*, Amsterdam: John Benjamins, 21-50.
- Chomsky, N., 1973, 'Conditions on transformations', in S. Anderson and P. Kiparsky (eds.), *A Festschrift for Morris Halle*, New York: Holt, Rinehart and Winston, 232-86.
- Chomsky, N., 1986, *Barriers*, Cambridge (MA): MIT Press.
- Chomsky, N., 1995, *The Minimalist Program*, Cambridge (MA): MIT Press.
- Cohen, A., 2001, 'On the generic use of indefinite singulars', *Journal of Semantics* 18.3, 183-209.
- Collins, P., 1995, 'The indirect object construction in English: an informational approach', *Linguistics* 33, 35-49.
- Cook, V.J., 1976, 'A note on indirect objects', *Journal of Child Language* 3, 435-438.
- Crain, S., 1992, 'The semantic subset principle in the acquisition of quantification', paper presented at the *Workshop on the Acquisition of Wh-Extraction and Related Work on Quantification*, Amherst (MA): University of Massachusetts, July 1992.
- Crain, S. and C. McKee, 1985, 'The acquisition of structural restrictions on anaphora', in S. Berman, J.W. Choe, and J. McDonough (eds.), *Proceedings of NELS 16*, University of Massachusetts, Amherst (MA): GLSA.
- Crain, S., R. Thornton, C. Boster, L. Conway, D. Lillo-Martin and E. Woodams, 1996, 'Quantification without qualification', *Language Acquisition* 5, 83-153.
- Dalrymple, M., M. Kanazawa, Y. Kim, S. Mchombo and S. Peters, 1998, 'Reciprocal Expressions and the Concept of Reciprocity', *Linguistics and Philosophy* 21, 159-210.
- Davidson, D., 1967, 'The logical form of action sequences', in N. Rescher (ed.), *The Logic of Decision and Action*, Pittsburgh: University of Pittsburgh Press, 81-120.
- De Villiers, J.G., T. Roeper and A. Vainikka, 1990, 'The acquisition of long distance rules' in L. Frazier and J. G. de Villiers (eds.), *Language Processing and Acquisition*, Dordrecht: Kluwer.
- Donaldson, M. and P. Lloyd, 1974, 'Sentences and situations: children's judgments of match and mismatch', *Problèmes Actuels en Psycholinguistique*, 73-86.

- Dowty, D., 1986, 'A note on collective predicates, distributive predicates and all', in Marshall (ed.), *ESCOL 86*, Columbus: Ohio State University.
- Drozd, K. F., 2001, 'Children's weak interpretation of universally quantified sentences', in M. Bowerman and S. Levinson (eds.), *Conceptual development and language acquisition*, Cambridge: Cambridge University Press, 340-376.
- Drozd, K.F. and E. Van Loosbroek, 2006, 'The effect of context on children's interpretations of universally quantified sentences', in V. van Geenhoven (ed.), *Semantics meets Acquisition*, Dordrecht: Kluwer.
- Dryer, M.S., 1986, 'Primary objects, secondary objects and antidative', *Language* 62, 808-845.
- Ebert, C. and C. Endriss, 2004, 'Topic interpretation and wide scope indefinites' in *Proceedings of NELS 34*, Amherst: GLSA.
- Erteshik-Shir, N., 1979, 'Discourse constraints on dative movement', in S. Laberge and G. Sankoff (eds.), *Syntax and Semantics*, Vol. 12, New York: Academic Press.
- Farkas, D., 1994, 'Specificity and scope', in L. Nask and G. Tsoulas (eds.), *Langue et Grammaire*, Paris: Universite Paris 8, 119-137.
- Flobbe L., R. Verbrugge, P. Hendriks, and I. Krämer, 2008, 'Children's application of Theory of Mind in reasoning and language', *Journal of Logic, Language and Information* 17.4, 417-442.
- Fodor, J.D. and I.A. Sag, 1982, 'Referential and quantificational indefinites', *Linguistics and Philosophy* 5, 355-398.
- Fox, D., 1995, 'Economy and scope', *Natural Language Semantics* 3, 283-341.
- Freeman, N.H., C. Sinha and J. Stedmon, 1982, 'All the cars- which cars? From word meaning to discourse analysis', in M. Beveridge (ed.), *Children Thinking Through Language*, London: Edward Arnold, 52-74.
- Frey, W., 1993, *Syntaktische Bedingungen über die semantische Interpretation. Über Bindung, implizite Argumente und Skopus*, Berlin: Akademie Verlag.
- Geurts, B., 2003, 'Quantifying kids', *Language Acquisition* 11.4, 197-218.
- Giannakidou, A., 2002, 'Licensing and sensitivity in polarity items: from downward entailment to (non)veridicality', *Chicago Linguistic Society 38: Parasession on Polarity and Negation*, 29-54.
- Gil, D., 1995, 'Universal quantifiers and distributivity', in E. Bach, E. Jelinek, A. Kratzer and B.H. Partee (eds.), *Quantification in Natural Languages*, Dordrecht: Kluwer, 321-362.

- Givón, T., 1979, *On Understanding Grammar*, New York: Academic Press.
- Givón, T., 1984, *Syntax. A Functional-Typological Introduction*, Vol.1, Amsterdam: John Benjamins.
- Goldberg, A.E., 2006, *Constructions at Work: The Nature of Generalization in Language*, Oxford: Oxford University Press.
- Gordon, P., 1982, *The Acquisition of Syntactic Categories: the Case of the Count/Mass Distinction*, Doctoral dissertation, MIT.
- Gordon, P., 1996, 'The truth-value judgment task', in D. McDaniel, C. McKee and H.S. Cairns (eds.), *Methods for Assessing Children's Syntax*, Cambridge (MA): MIT Press, 211-231.
- Goro, T., 2007, *Language specific constraints on scope interpretation in first language acquisition*, Doctoral Dissertation, University of Maryland.
- Grimshaw, J. and S.T. Rosen, 1990, 'Knowledge and obedience: the developmental status of binding theory', *Linguistic Inquiry* 21.2, 197-222.
- Gualmini, A., 2004, *The Ups and Downs of Child Language*, New York: Routledge.
- Halbert, A.M., S. Crain, D. Shankweiler and E. Woodams, 1995, 'Interpretive use of emphatic stress by children', poster presented at CUNY 8, Tucson, AZ.
- Hanlon, C., 1988, 'The emergence of set-relational quantifiers in early childhood' in F.S. Kessel, *The Development of Language and Language Researchers, Essays in Honor of Roger Brown*, Hillsdale (NJ): Lawrence Erlbaum Associates.
- Heizman, T., 2008, '(Un)Frozen Scope in English and German Double Object Constructions', Poster presented at CUNY 21, Conference on Human Sentence Processing, University of North Carolina, Chapel Hill.
- Hendriks, P., R. Koops van 't Jagt and J. Hoeks, to appear, 'Restricting quantifier scope in Dutch: Evidence from child language comprehension and production', to appear in B. Stolterfoht and S. Featherston (eds.), *Empirical approaches to linguistic theory: Studies of meaning and structure*. Studies in Generative Grammar, De Gruyter.
- Hickman, M., 1982, *The Development of narrative skills: pragmatic and metapragmatic aspects of discourse cohesion*. Doctoral dissertation, University of Chicago.
- Hollebrandse, B. and S. Visser, 2006, 'Temporal quantification and events in Dutch child language' *Linguistics in the Netherlands*, John Benjamins Publishing.

- de Hoop, H., 2003, 'Scrambling in Dutch: Optionality and Optimality', in S. Karimi (ed.), *Word Order and Scrambling*, Pxford: Blackwell Publishers.
- Hulsey, S., V. Hacquard, D. Fox, A. Gualmini, 2004, 'The question-answer requirement and scope assignment', in A. Czirmaz, A. Gualmini and A. Nevins (eds.), *Plato's Problem: Problems in Language Acquisition*, Cambridge (MA): MITWPL, 71-90.
- Inhelder, B. and J. Piaget, 1964, *The early growth of logic in the child*, London: Routhledge.
- Ionin, T., 2001, 'The one girl who was kissed by every boy: scope, scrambling and discourse function in Russian', *Proceedings of Console X*.
- Ioup, G., 1975, 'Some universals for quantifier scope', in J. Kimball (ed.) *Syntax and Semantics 4*, New York: Academic Press, 37-58.
- Kadmon, N. and F. Landman, 1993, 'Any', *Linguistics and Philosophy* 16, 353-422.
- Karmiloff-Smith, A., 1981, 'The grammatical marking of thematic structure in the development of language predication', in W. Deutsch (ed.) *The child's construction of language*, London, Academic Press, 123-147.
- Karmiloff-Smith, A., 1985, 'Language and cognitive processes from a developmental perspective', *Language and Cognitive Processes*, 1, 61-85.
- Kennelly, S.D., 2004, *Quantificational Dependencies*, Doctoral Dissertation, Utrecht University.
- Koopman, H. and D. Sportiche, 1982, 'Variables and the bijection principle', *The Linguistic Review* 2, 139-160.
- Krämer, I., 2000, *Interpreting indefinites: an experimental study of children's language comprehension*, Doctoral dissertation, Utrecht University.
- Kratzer, A., 1989, 'An investigation of the lumps of thought', *Linguistics and Philosophy* 12, 607-653.
- Kratzer, A., 2003, 'A note on choice functions in context' *SemanticsArchive.net*.
- Krifka, M., 1990, 'Four thousand ships passed through the lock: object induced measure functions on events', *Linguistics and Philosophy* 13, 487-520.
- Krifka, M., 1998, 'Scope inversion under the rise-fall pattern in German', *Linguistic Inquiry* 29.1, 75-112.
- Kurtzman, H.S. and M.C. MacDonald, 1993, 'Resolution of quantifier scope ambiguities', *Cognition* 48, 243- 279.

- Ladusaw, 1979, *Polarity Sensitivity as Inherent Scope Relations*, New York: Garland.
- Lambrecht, K., 1994, *Information Structure and Sentence Form*, Cambridge: Cambridge University Press.
- Landman, F., 1989, 'Groups I', *Linguistics and Philosophy* 12, 559-605.
- Landman, F., 1996, 'Plurality', in S. Lappin (ed.) *The Handbook of Contemporary Semantic Theory*, Oxford: Blackwell Press.
- Landman, F., 2000, *Events and Plurality: the Jerusalem Lectures*, Dordrecht: Kluwer.
- Langacker, R.W., 1987, *Foundations of Cognitive Grammar*, Vol. 1, Stanford (CA): Stanford University Press.
- Larson, R.K., 1988, 'On the double object construction', *Linguistic Inquiry* 19, 335-391.
- Larson, R.K., 1990, 'Double objects revisited: reply to Jackendoff', *Linguistic Inquiry* 21, 589-632.
- Larson, R.K. and R. May, 1990, 'Antecedent containment or vacuous movement: reply to Baltin', *Linguistic Inquiry* 21, 103-122.
- Lasersohn, P., 1988, *A Semantics for Groups and Events*, Doctoral Dissertation, Columbus: Ohio State University.
- Lasersohn, P., 1995, *Plurality, Conjunction, and Events*, Dordrecht: Kluwer.
- Lechner, W., 2009, 'Evidence for Survive from covert movement', in M. Putnam (ed.), *The Survive Principle in a Crash-Proof Syntax*, Amsterdam: John Benjamins, 231-254.
- Lee, T. H.-T., 1986, *Studies on Quantification in Chinese*, Doctoral Dissertation, University of California.
- Levin, B., 1993, *English Verb Classes and Alternations: a Preliminary Investigation*, Chicago: University of Chicago Press.
- Lewis, D., 1979, 'Scorekeeping in a language game', *Journal of Philosophical Logic* 8, 339-359.
- Lidz, J. and J. Musolino, 2002, 'Children's command of quantification', *Cognition* 84.2, 113-154.
- Lidz, J., E. McMahon, K. Syrett, J. Viau, F. Anggoro, J. Peterson-Hicks, E. Sneed, A. Bunker, T. Flevaris, A. Graham, K. Grohne, Y. Lee and J. Evar Strid, 2004, 'Quantifier raising in 4-year olds', in A. Brugos, I. Micciulla and C.E. Smith, *BUCLD 28 Proceedings*, Somerville (MA): Cascadilla Press, 340-349.
- Lightbown, P.M. and N. Spada, 1999, *How Languages are Learned*, Oxford: Oxford University Press.
- Link, G., 1983, 'The logical analysis of plural and mass terms: a lattice-theoretical approach', in R. Bäuerle, C. Schwarz and A. von

- Stechow (eds.) *Meaning, Use and Interpretation of Language*, Berlin: Walter de Gruyter, 302-323.
- Liu, F.-H., 1997, *Specificity and Scope*, Amsterdam: John Benjamins.
- Lloyd, P. and M. Donaldson, 1976, 'On a method of eliciting true/false judgments from young children', *Journal of Child Language* 3, 411-416.
- MacWhinney, B., 1977, 'Starting points', *Language* 53, 152-168.
- Maranz, A., 1993, 'Implications of asymmetries in double object constructions', in S.A. Mchombo (ed.), *Theoretical Aspects of Bantu Grammar*, Stanford (CA): CSLI Publications, 113-150.
- Maratsos, M., 1976, *The Use of Definite and Indefinite Reference in Young Children: An Experimental Study of Semantic Acquisition*, Cambridge: Cambridge University Press.
- Markman, E.M., 1989, *Categorization and naming in children*, Cambridge MA: MIT Press.
- May, R., 1977, *The grammar of quantification*, Doctoral Dissertation, MIT.
- May, R., 1985, *Logical Form: its structure and derivation*, Cambridge (MA): MIT Press.
- McDaniel, D. and T.L. Maxfield, 1992 'Principle B and contrastive stress', *Language Acquisition* 2, 337-358.
- Milsark, G., 1977, 'Toward an explanation of certain peculiarities of the existential construction in English', *Linguistic Analysis* 3, 1-30.
- Musolino, J., 1998, *Universal Grammar and the Acquisition of Semantic Knowledge*, Doctoral dissertation, University of Maryland.
- Musolino, J. and J. Lidz, 2003, 'The scope of Isomorphism: turning adults into children', *Language Acquisition*, 11.4, 277-291.
- Musolino, J. and J. Lidz, 2006, 'Why children aren't universally successful with quantification', *Linguistics* 44.4, 817-852.
- Naganishi, K., 2001a, 'Frozen scope and weak crossover in ditransitives', in M. Cuervo *et al* (eds.), *Proceedings of the Third Formal Approaches to Japanese Linguistics (FAJL3): MIT Working Papers in Linguistics* 41, 109-126.
- Naganishi, K., 2001b, 'Indefinites and Frozen Scope in Japanese: restriction on QR and choice functions', in K. Megerdooian and L.A. Bar-el (eds.), *WCCFL 20 Proceedings*, 456-469.
- Narasimhan, B. & C. Dimroth, 2008, 'Word order and information status in child language', *Cognition* 107, 317-329.
- Parsons, T., 1990, *Events in the Semantics of English: a Study in Subatomic Semantics*, Cambridge (MA): MIT Press.
- Partee, B. H., 1984, 'Compositionality', in F. Landman and F. Veldman (eds.), *Varieties of Formal Semantics. Proceedings of the 4th Amsterdam Colloquium*, Dordrecht: Foris, 281-311.

- Philip, W.C.H., 1995, *Event quantification in the acquisition of universal quantification*, Doctoral Dissertation, University of Massachusetts, Amherst.
- Philip, W.C.H., 1996, 'Symmetrical interpretation: A Scope Ambiguity in the Acquisition of Quantification in Dutch', in *Proceedings of the Groningen Assembly on Language Acquisition*, 293-302.
- Philip, W.C.H., 2005, 'Pragmatic control of specificity and scope: Evidence from Dutch L1A', in E. Maier, C. Bary and J. Huitink (eds.), *Proceedings of SUB9*, Nijmegen: NCS, 271-285.
- Philip, W.C.H. and P.H.A. Coopmans, 1995, 'Symmetrical interpretation and scope ambiguity in the acquisition of universal quantification in Dutch and English' in J. Don, B. Schouten and W. Zonneveld (eds.), *OTS Yearbook 1994*, 85-134.
- Philip, W.C.H.. and M. Termeer, 2003, TIN-Dag presentation.
- Polinsky, M., 1998, 'A non-syntactic account of some asymmetries in the double-object construction', in J.-P. Koenig (ed.), *Conceptual Structure and Language: Bridging the Gap*, Stanford (CA): CSLI Publications: 401-420.
- Pinker, S., 1984, *Language Learnability and Language Development*, Cambridge (MA): Harvard University Press.
- Rakhlin, N., 2007a, 'A new pragmatic account of quantifier spreading', *Nanzan Linguistics: Special Issue 3.1*, 239-282.
- Rakhlin, N., 2007b, 'Children's interpretation of negative determiners as a window into Q-spreading', in Al. Belikova et al. (eds.), *Proceedings of GALANA*, Somerville (MA): Cascadilla, 363-373.
- Ramchand, G., 2007, 'Events in syntax: modification and predication', *Language and Linguistics Compass 1/5*, 476-497.
- Reinhart, T., 1995, *Interface Strategies*, OTS, Utrecht University.
- Reinhart, T., 1997, 'Quantifier Scope: How Labor Is Divided between QR and Choice Functions', *Linguistics & Philosophy*, 20.4, 335-397.
- Richards, N., 1997, *What moves where when in which language?*, Doctoral Dissertation, MIT.
- Roeper, T, and J. de Villiers, 1991, 'The emergence of bound variable structures', *UMOPS Special Edition: Papers in the Acquisition of WH*, Amherst (MA): GLSA, 225-265.
- Roeper, T., S. Lapointe, J. Bing, and S. Tavakolian, 1981, 'A lexical approach to language acquisition', in S.Tavakolian (ed.) *Language Acquisition and Linguistic Theory*, Cambridge (MA): MIT Press, 35-58.
- Ruys, E.G., 1992, *The Scope of Indefinites*, Doctoral dissertation, Utrecht University.

- Ruys, E.G., 2001, 'Dutch scrambling and the strong-weak distinction', *Journal of Comparative Germanic Linguistics*, 4.1, 39-67.
- Sag, I., 1976, *Deletion and Logical Form*, Doctoral dissertation, MIT.
- Sano, T., 2004, 'Scope relations of QPs and scrambling in the acquisition of Japanese', in N.J. van Kampen and S. Baauw (eds.) *Proceedings of GALA 2003*, LOT.
- Sauerland, U., 2008, 'Implicated Presuppositions', in A. Steube (ed.), *Sentence and Context*. Berlin: Mouton de Gruyter.
- Scha, R.J.H., 1981, 'Distributive, collective and cumulative quantification', in J. Groenendijk, T. Janssen and M. Stokhof (eds.), *Formal Methods in the Study of Language*, Amsterdam: Mathematisch Centrum, 483-512.
- Schein, B., 1993, *Plurals and Events*, Cambridge (MA): MIT Press.
- Schwarzschild, R., 2002, 'Singleton indefinites', *Journal of Semantics* 19.3, 289-314.
- Smits, E.J., 2010, *Acquiring Quantification: How children use semantics and pragmatics to constrain meaning*, Doctoral Dissertation, University of Groningen.
- Snyder, W. and K. Stromswold, 1997, 'The structure and acquisition of English dative constructions', *Linguistic Inquiry* 28.2, 281-317.
- Solan, L., 1980, 'Contrastive stress and children's interpretation of pronouns', *Journal of Speech and Hearing Research* 23, 688-698.
- Stenning, K. and L. Mitchell, 1985, 'Learning how to tell a good story: the development of content and language in children's telling of one tale', *Discourse Processes*, 8, 261-279.
- Strawson, 1974, *Subject and predicate in logic and grammar*, London: Methuen.
- Su, Y.-C., 2001a, 'Scope and specificity in child language', *BUCLD 25 Proceedings*, 744-755.
- Su, Y.-C., 2001b, *Scope and specificity in child language: a cross-linguistic study on English and Chinese*, Doctoral Dissertation, University of Maryland.
- Su, Y.-C., 2008, 'Structure and context effects in scope ambiguity resolution', *Language and Linguistics* 9.3, 585-627.
- Su, Y.-C. and S. Crain, 2000, 'Children's scope taking in double-object constructions' *CLS 36: the Panels*, 485-498.
- Szabolcsi, A., 1997, *Ways of Scope Taking*, Dordrecht: Kluwer.
- Thompson, S.A., 1990, 'Informational flow and dative shift in English discourse', in J. Edmondson, K. Feagin and P. Mühlhäusler (eds.), *Development and Diversity: Linguistic Variation across Time and Space* (Summer Institute of Linguistics), 239-253.

- Thornton, R., 1990, *Adventures in Long-Distance Moving: The Acquisition of Complex Wh-Questions*, Doctoral dissertation, University of Connecticut, Storrs.
- Trueswell, J.C., I. Sekerina, N.M. Hill and M.L. Logrip, 1999, 'The kindergarten-path effect: studying on-line sentence processing in young children', *Cognition* 73, 89-134.
- Tunstall, S., 1998, *The interpretation of quantifiers: semantics and processing*, Doctoral dissertation, University of Massachusetts, Amherst.
- Unsworth, S., 2005, *Child L2, Adult L2, Child L1: Differences and Similarities. A study on the acquisition of direct object scrambling in Dutch*, Doctoral Dissertation, Utrecht University.
- Unsworth, S., A. Gualmini and C.J.M. Helder, 2008, 'Children's interpretation of indefinites in negative sentences: A re-assessment of the cross-linguistic picture', *Language acquisition*, 15, 315-328.
- Van Geenhoven, V., 1998, *Semantic incorporation and indefinite descriptions: Semantic and syntactic aspects of noun incorporation in West Greenlandic*, Stanford: Stanford University Press.
- Van Hoek, K., 1995, 'Conceptual reference points: a cognitive grammar account of pronominal anaphora constraints', *Language* 71, 310-340.
- Van der Ziel, M.E., 2008, *The Acquisition of the Weak Crossover Constraint: Evidence from Dutch Preschool Children*, Unpublished MA-thesis, Utrecht University.
- Vendler, Z., 1967, *Linguistics in philosophy*, Ithaca (NY): Cornell University Press.
- Verkuyl, H., 1994, 'Distributivity and collectivity a couple at odds', in M. Kanazawa and C.J. Piñon (eds.), *Dynamics, Polarity and Quantification*, Stanford: CSLI, 49-80.
- Waryas, C. and K. Stremel, 1974, 'On the preferred form of the double-object construction', *Journal of Psycholinguistic Research* 3, 217-279.
- Westerståhl, D., 1985, 'Determiners and context sets', in J. van Benthem and A. ter Meulen (eds.), *Generalized Quantifiers in Natural Language*, Dordrecht: Foris.
- Westerståhl, D., 1989, 'Quantifiers in formal and natural languages', in D. Gabbay and F. Guenther (eds.), *Handbook of Philosophical Logic* Vol.4, Dordrecht: Kluwer, 1-131.
- Wurmbrandt, S., 2008, 'Word order and scope in German', in J-W. C. Zwart (ed.). *Groninger Arbeiten zur germanistischen Linguistik* 46, Groningen: University of Groningen, 89-110.

Appendix 1:

Test Stories Experiment I

Name: 'Refrigerator Story'
 Type: IS-True and IS-False conditions
 Predicate: *eten* 'to eat'

Background: Three cats and a dog are hungry and go looking for food in the refrigerator. When they open the door of the refrigerator they find three sausages, three carrots and a piece of cheese.

ALL>ONE event: Each of the cats eats a sausage and the dog eats a piece of cheese.

ONE>ALL event: One of the cats is still hungry and notices that there are still three carrots left in the refrigerator. He decides to eat all of them.

Test and control statements:

- *Elke kat is zwart* (Q False1).
Every cat is black.¹¹²
- *Een kat heeft elke worst opgegeten* (IS-F) .
A cat ate every sausage.
- *Een kat heeft elke wortel opgegeten* (IS-T).
A cat ate every carrot.

Name: 'Birthday Story' version 1
 Type: Dative (DO-dat, PP-dat, SPP-dat)
 Predicate: *geven* ('to give')
 Event order: ONE>ALL precedes ALL>ONE

Background: In a very large forest there lives a bear, and today he is celebrating his birthday. For that reason, he is having a party. The bear has invited all of his friends: three hedgehogs and a mouse. After his friends congratulate him on his birthday, the bear offers them some cake. He has three pieces of cake on a plate.

¹¹² In all cases the English translation is an approximate translation.

ONE>ALL event: The first hedgehog declines because he does not like cake. The second hedgehog declines because he is not hungry. The bear then offers the mouse a piece of cake, but the mouse states that the pieces are too big for him and declines as well. The third hedgehog boasts that he is very hungry and could well eat all three pieces of cake. Consequently the bear gives him all of the pieces of cake.

Test and Control Statements:¹¹³

- *Elke egel heeft een blauwe trui aan* (Q False2).
Every hedgehog is wearing a blue jumper.
- *Er staat een kaarsje op elk stuk taart* (Q True1).
There is a candle on every piece of cake.
- *De beer heeft een egel elk stuk taart gegeven* (DO-dat).
The bear gave a hedgehog every piece of cake.
- *De beer heeft elk stuk taart aan een egel gegeven* (PP-dat).
The bear gave every piece of cake to a hedgehog.
- *De beer heeft aan een egel elk stuk taart gegeven* (SPP-dat).
The bear gave to a hedgehog every piece of cake.

Intermediate: The hedgehogs have brought the bear two presents.

Control Statements:

- *De egel heeft de muis twee cadeautjes gegeven*
(Control DO-dat False 1).
The hedgehog gave the mouse two presents.
- *De egel heeft twee cadeautjes aan de muis gegeven*
(Control PP-dat False1)
The hedgehog gave two presents to the mouse.
- *De egel heeft aan de muis twee cadeautjes gegeven*
(Control SPP-dat False1)
The hedgehog gave to the mouse two presents.
- *De egel heeft de beer twee cadeautjes gegeven*
(Control DO-dat True 1).
The hedgehog gave the bear two presents.
- *De egel heeft twee cadeautjes aan de beer gegeven*
(Control PP-dat True 1).
The hedgehog gave two presents to the bear.

¹¹³ Only control conditions that were included in test stories are included in the appendices.

- ***De egel heeft aan de beer twee cadeautjes gegeven***
(Control SPP-dat True1).
The hedgehog gave to the bear two presents.

ALL>ONE event: The bear also has three party hats and a balloon and he wants to give them to his friends. He puts one of the hats on the head of one of the hedgehogs. Then he gives another hedgehog one of the hats. He asks whether the mouse also wants one. The mouse replies that he would love one, but that he thinks the hat would be too big for him. He tries it on and it is indeed too big. The mouse then gets the balloon, and the third hedgehog gets the last party hat.

Test and Control conditions:

- ***Elk hoedje was geel*** (Q False3)
Every party hat was yellow.
- ***De beer heeft een egel elk hoedje gegeven*** (DO-dat).
The bear gave a hedgehog every hat.
- ***De beer heeft aan een egel elk hoedje gegeven*** (PP-dat).
The bear gave to a hedgehog every hat.
- ***De beer heeft elk hoedje aan een egel gegeven*** (SPP-dat).
The bear gave every hat to a hedgehog.

Name: 'Birthday Story' version 2
Type: Dative (DO-dat, PP-dat, SPP-dat)
Predicate: *geven* ('to give')
Event order: ALL>ONE precedes ONE>ALL

Background: In a very large forest there lives a bear, and today he is celebrating his birthday. For that reason, he is having a party. The bear has invited all of his friends: three hedgehogs and a mouse. After his friends congratulate him on his birthday, the bear tells them he has three party hats and a balloon which he wants to give to them.

ALL>ONE event: He puts one of the hats on the head of one of the hedgehogs. Then he gives another hedgehog one of the hats. He asks whether the mouse also wants one. The mouse replies that he would love one, but that he thinks the hat would be too big for him. He tries it on and it is indeed too big. The mouse then gets the balloon, and the third hedgehog gets the last party hat.

Test and Control conditions:

- ***Elke egel heeft een blauwe trui aan*** (Q False2).

- **Every hedgehog is wearing a blue jumper.**
Elk hoedje was geel (Q False3)
- **Every party hat was yellow.**
De beer heeft een egel elk hoedje gegeven (DO-dat).
- **The bear gave a hedgehog every hat.**
De beer heeft aan een egel elk hoedje gegeven (PP-dat).
- **The bear gave to a hedgehog every hat.**
De beer heeft elk hoedje aan een egel gegeven (SPP-dat).
- **The bear gave every hat to a hedgehog.**

Intermediate: The hedgehogs have brought the bear two presents.

Control Statements:

- *De egel heeft de muis twee cadeautjes gegeven*
(Control DO-dat False 1).
The hedgehog gave the mouse two presents.
- *De egel heeft twee cadeautjes aan de muis gegeven*
(Control PP-dat False1)
The hedgehog gave two presents to the mouse.
- *De egel heeft aan de muis twee cadeautjes gegeven*
(Control SPP-dat False1)
The hedgehog gave to the mouse two presents.
- *De egel heeft de beer twee cadeautjes gegeven*
(Control DO-dat True 1).
The hedgehog gave the bear two presents.
- *De egel heeft twee cadeautjes aan de beer gegeven*
(Control PP-dat True 1).
The hedgehog gave two presents to the bear.
- *De egel heeft aan de beer twee cadeautjes gegeven*
(Control SPP-dat True1).
The hedgehog gave to the bear two presents.

ONE>ALL event: The bear then asks his friends whether they would like some cake. He holds a plate with three pieces of cake. The first hedgehog declines because he does not like cake. The second hedgehog declines because he is not hungry. The bear then offers the mouse a piece of cake, but the mouse states that the pieces are too big for him and declines as well. The third hedgehog boasts that he is very hungry and could well eat all three pieces of cake. Consequently the bear gives him all of the pieces of cake.

Test and Control Statements:

- *Er staat een kaarsje op elk stuk taart* (Q True1).
There is a candle on every piece of cake.
- *De beer heeft een egel elk stuk taart gegeven* (DO-dat).
The bear gave a hedgehog every piece of cake.
- *De beer heeft aan een egel elk stuk taart gegeven* (SPP-dat).
The bear gave to a hedgehog every piece of cake.
- *De beer heeft elk stuk taart aan een egel gegeven* (PP-dat).
The bear gave every piece of cake to a hedgehog.

Name: 'Shop Story' version 1
 Type: Dative Sentence (DO-dat, PP-dat, SPP-dat)
 Predicate: *verkopen* 'to sell'
 Event order: ALL>ONE precedes ONE>ALL

Background: Three girls and a boy are invited to a party and decide to go and buy new clothes to wear to the party. They go the shop owned by a rabbit.

ALL>ONE event: The rabbit shows the children three dresses (a yellow one, a blue one and a green one). The rabbit sells one of the girls a yellow dress. The rabbit sells the second girl a blue dress. The rabbit tries to sell the boy a dress, but he refuses exclaiming that dresses are not for boys. The rabbit then sells his last (green) dress to the third girl. The boy buys a baseball cap.

Test and control statements:

- *Elk meisje heeft een roze rokje aan* (Q True 2).
Every girl is wearing a pink skirt.
- *Alle jurken zijn groen* (Q False 4).
All the dresses are green.
- *Het konijn heeft een meisje elke jurk verkocht* (DO-Dat).
The rabbit sold the girl every dress.
- *Het konijn heeft aan een meisje elke jurk verkocht* (SPP-Dat).
The rabbit sold to a girl every dress.
- *Het konijn heeft elke jurk aan een meisje verkocht* (PP-Dat).
The rabbit sold every dress to a girl.

Intermediate: The children decide that they should also buy presents to take to the party. The rabbit shows them a set of dolls and two toy cars.

Test and Control statements:

- *Het konijn heeft de kinderen een voetbal laten zien*
(Control DO-dat False2).
The rabbit showed the children a football.
- *Het konijn heeft aan de kinderen een voetbal laten zien*
(Control SPP-dat False 2).
The rabbit showed to the children a football.
- *Het konijn heeft een voetbal aan de kinderen laten zien*
(Control PP-dat False 2).
The rabbit showed a football to the children.

- *Het konijn heeft de kinderen twee speelgoedauto's laten zien*
(Control DO-dat True2).
The rabbit showed the children a toy car.
- *Het konijn heeft aan de kinderen twee speelgoedauto's laten zien*
(Control SPP-dat True 2).
The rabbit showed to the children a toy car.
- *Het konijn heeft twee speelgoed auto's aan de kinderen laten zien*
(Control PP-dat True 2).
The rabbit showed two toy cars to the children.

ONE>ALL: The rabbit then shows the children three teddy bears. Two of the girls and the boy do not want to buy any of the teddy bears. However, the third girl likes them very much, and decides to buy all of them.

Test and Control Statements:

- *Elke teddybeer is bruin* (Q True 3).
Every teddy bear is brown.
- *Het konijn heeft een meisje elke teddybeer verkocht* (DO-Dat).
The rabbit sold a girl every teddy bear.
- *Het konijn heeft aan een meisje elke teddybeer verkocht* (SPP-Dat).
The rabbit sold to a girl every teddy bear.
- *Het konijn heeft elke teddybeer aan een meisje verkocht* (PP-Dat).
The rabbit sold every teddy bear to a girl.

Name: 'Shop Story' version 2
 Type: Dative Sentence (DO-dat, PP-dat, SPP-dat)
 Predicate: *verkopen* 'to sell'
 Event order: ONE>ALL precedes ALL>ONE

Background: Three girls and a boy are invited to a party and decide to go and buy presents to take to the party. They go the shop owned by a rabbit.

Control event: The rabbit shows them a set of dolls and two toy cars.

Control Statements:

- *Het konijn heeft de kinderen een voetbal laten zien*
 (Control DO-dat False2).
The rabbit showed the children a football.
- *Het konijn heeft aan de kinderen een voetbal laten zien*
 (Control SPP-dat False 2).
The rabbit showed to the children a football.
- *Het konijn heeft een voetbal aan de kinderen laten zien*
 (Control PP-dat False 2).
The rabbit showed a football to the children.
- *Het konijn heeft de kinderen twee speelgoedauto's laten zien*
 (Control DO-dat True2).
The rabbit showed the children a toy car.
- *Het konijn heeft aan de kinderen twee speelgoedauto's laten zien*
 (Control SPP-dat True 2).
The rabbit showed to the children a toy car.
- *Het konijn heeft twee speelgoed auto's aan de kinderen laten zien*
 (Control PP-dat True 2).
The rabbit showed two toy cars to the children.

ONE>ALL: The rabbit subsequently shows the children three teddy bears. Two of the girls and the boy do not want to buy any of the teddy bears. However, the third girl likes them very much, and decides to buy all of them.

Test and Control Statements:

- *Elk meisje heeft een roze rokje aan* (Q True 2).
Every girl is wearing a pink skirt.
- *Elke teddybeer is bruin* (Q True 3).
Every teddy bear is brown.
- *Het konijn heeft een meisje elke teddybeer verkocht* (DO-Dat).
The rabbit sold a girl every teddy bear.

- *Het konijn heeft aan een meisje elke teddybeer verkocht* (SPP-Dat).
The rabbit sold to a girl every teddy bear.
- *Het konijn heeft elke teddybeer aan een meisje verkocht* (PP-Dat).
The rabbit sold every teddy bear to a girl.

ALL>ONE event: The children decide that they also need some new clothes to wear to the party. The rabbit shows the children three dresses (a yellow one, a blue one and a green one). The rabbit sells one of the girls a yellow dress. The rabbit sells the second girl a blue dress. The rabbit tries to sell the boy a dress, but he refuses exclaiming that dresses are not for boys. The rabbit then sells his last (green) dress to the third girl. The boy buys a baseball cap.

Test statements:

- *Alle jurken zijn groen* (Q False 4).
All the dresses are green.
- *Het konijn heeft een meisje elke jurk verkocht* (DO-Dat).
The rabbit sold the girl every dress.
- *Het konijn heeft aan een meisje elke jurk verkocht* (SPP-Dat).
The rabbit sold to a girl every dress.
- *Het konijn heeft elke jurk aan een meisje verkocht* (PP-Dat).
The rabbit sold every dress to a girl.

Name: 'Letters and Packages Story' version 1
 Type: Dative Sentence (DO-dat, PP-dat, SPP-dat)
 Predicate: *brenge* 'to bring'
 Event order: ONE>ALL precedes ALL>ONE

Background: A monkey opens his mailbox and finds three packages and three letters which are not addressed to him, but to others. He decides to bring them to the correct people.

ONE>ALL event: The monkey puts the packages in his wheelbarrow and goes on his way. He meets three gnomes and a frog. Gnome 1 asks the monkey whether one of the packages is for him, the monkey tells him it is not. Gnome 2 also asks, but the monkey does not have any packages for him. The frog also wants to know whether the monkey is bringing him a package, but the monkey instead brings all three packages to the third gnome.

Test and Control Statements:

- *Elke kabouter draagt een puntmuts* (Q True 4).
Every gnome is wearing a pointy hat.
- *Ieder pakje is rood* (Q False 5).
Every package is red.
- *De aap heeft een kabouter elk pakje gebracht* (DO-Dat).
The monkey brought a gnome every package.
- *De aap heeft naar een kabouter elk pakje gebracht* (SPP-Dat).
The monkey brought to a gnome every package.
- *De aap heeft elk pakje naar een kabouter gebracht* (PP-Dat).
The monkey brought every package to a gnome.

Intermediate: The monkey wants to deliver the three letters to the correct people as well. However, the wheel comes off his wheelbarrow and the monkey cannot go on. One of the gnomes lends him his bike.

Control Statements:

- *De kabouter heeft de aap een auto geleend*
(Control Do-dat False 3).
The gnome lent the monkey a car.
- *De kabouter heeft aan de aap een auto geleend*
(Control SPP-dat False 3).
The gnome lent to the monkey a car.
- *De kabouter heeft een auto aan de aap geleend*
(Control SPP-dat False 3).
The gnome lent a car to the monkey.
- *De kabouter heeft de aap een fiets geleend* (Control Do-dat True 3).
The gnome lent the monkey a bicycle.
- *De kabouter heeft aan de aap een fiets geleend*
(Control SPP-dat True 3).
The gnome lent to the monkey a car.
- *De kabouter heeft een fiets aan de aap geleend*
(Control PP-dat True 3).
The gnome lent a bicycle to the monkey.

ALL>ONE event: The monkey then hops on the bicycle and goes off to deliver the letters on the bike. In the distance he sees three mice and a rabbit. He brings a letter to mouse 1, and then he brings a letter to mouse 2. The monkey does not have a letter for the rabbit, but he does bring a letter to the third mouse.

Test statements:

- *Iedere muis heeft een hoed op* (Q False 6).
Every mouse has a hat on.
- *Elke brief zat in een blauwe envelop* (Q True 5).
Every letter has a blue envelope.
- *De aap heeft een muisje elke brief gebracht* (DO-Dat).
The monkey brought a mouse every letter.
- *De aap heeft naar een muisje elke brief gebracht* (SPP-Dat).
The monkey brought to a mouse every letter.
- *De aap heeft elke brief naar een muisje gebracht* (PP-Dat).
The monkey brought every letter to a mouse.

Name: 'Letters and Packages Story' version 2
 Type: Dative Sentence (DO-dat, PP-dat, SPP-dat)
 Predicate: *brengen* 'to bring'
 Event order: ALL>ONE precedes ONE>ALL

Background: A monkey opens his mailbox and finds three packages and three letters which are addressed to him. He decides to bring them to the correct people.

ALL-ONE event: The monkey decides to deliver the letters first and heads out on his bike. In the distance he sees three mice and a rabbit. He brings a letter to mouse 1, and then he brings a letter to mouse 2. The monkey does not have a letter for the rabbit, but he does bring a letter to the third mouse.

Test and Control Statements:

- *Iedere muis heeft een hoed op* (Q False 6).
Every mouse has a hat on.
- *Elke brief zat in een blauwe envelop* (Q True 5).
Every letter has a blue envelope.
- *De aap heeft een muisje elke brief gebracht* (DO-Dat).
The monkey brought a mouse every letter.
- *De aap heeft naar een muisje elke brief gebracht* (SPP-Dat).
The monkey brought to a mouse every letter.
- *De aap heeft elke brief naar een muisje gebracht* (PP-Dat).
The monkey brought every letter to a mouse.

Intermediate: The monkey then wants to deliver the packages, but he loses one of the wheels of his bicycle. One of the mice then lends him his wheelbarrow.

Control Statements:

- *De muis heeft de aap een auto geleend* (Control Do-dat False 3).
The mouse lent the monkey a car.
- *De muis heeft aan de aap een auto geleend*
(Control SPP-dat False 3).
The mouse lent to the monkey a car.
- *De muis heeft een auto aan de aap geleend*
(Control SPP-dat False 3).
The mouse lent a car to the monkey.
- *De muis heeft de aap een kruitwagen geleend*
(Control Do-dat True 3).
The mouse lent the monkey a wheelbarrow.
- *De muis heeft aan de aap een kruitwagen geleend*
(Control SPP-dat True 3).
The mouse lent to the monkey a wheelbarrow.
- *De muis heeft een kruitwagen aan de aap geleend*
(Control PP-dat True 3).
The mouse lent a wheelbarrow to the monkey.

ONE-ALL event: The monkey goes home, puts the packages in his wheelbarrow and goes on his way again. He meets three gnomes and a frog. Gnome 1 asks the monkey whether one of the packages is for him, the monkey tells him it is not. Gnome 2 also asks, but the monkey does not have any packages for him. The frog also wants to know whether the monkey is bringing him a package, but the monkey brings all three packages to the third gnome.

Test and Control Statements:

- *Elke kabouter draagt een puntmuts* (Q True 4).
Every gnome is wearing a pointy hat.
- *Ieder pakje is rood* (Q False 5).
Every package is red.
- *De aap heeft een kabouter elk pakje gebracht* (DO-Dat).
The monkey brought a gnome every package.
- *De aap heeft naar een kabouter elk pakje gebracht* (SPP-Dat).
The monkey brought to a gnome every package.
- *De aap heeft elk pakje naar een kabouter gebracht* (PP-Dat).
The monkey brought every package to a gnome.

Appendix 2:***Child Performance on Control Conditions
Experiment I***

condition	type	N	total N	target response	% target-like
T	filler	2	86	true	97.7
F	filler	2	86	false	100
QT	quantifier control	5	215	true	99.5
QF	quantifier control	6	258	false	95.3
DATT ¹¹⁴	dative control	3	129	true	96.9
DATF	dative control	3	129	false	95.4

Table 1: Child Performance on Control Conditions

dative control	N	total N	target response	% target-like
DO-dat F	3	48	false	93.8
DO-dat T	3	48	true	95.8
PP-dat F	3	39	false	97.4
PP-dat T	3	39	true	100
SPP-dat F	3	42	false	95.2
SPP-dat T	3	42	true	95.2

Table 2: Child Performance per Dative Control Condition

¹¹⁴ The DAT control conditions tested three different dative constructions, e.g. Do-dative, PP-datives and SPP-datives. The results per construction are presented in table 2 below.

Appendix 3:

Stories Experiment II, III, V and VI

Name: 'Birthday Story'
 Type: Dative (DO-dat, PP-dat)
 Predicate: *geven* ('to give')
 Event order: ONE>ALL precedes ALL>ONE



In een heel groot bos woont een beer, en vandaag is deze beer jarig. En daarom geeft hij een feestje. De beer heeft al zijn vrienden uitgenodigd. Kijk daar komen er al een paar aan: 1, 2, 3 vossen, en een muis. "Gefeliciteerd, beer", zeggen de vossen. "Dankjewel," zegt de beer, "Willen jullie misschien een stukje taart?"

In a very large forest there lives a bear, and today is his birthday. Therefore, he is giving a party. The bear has invited all of his friends. Look, some of them are arriving already: one, two, three foxes and a mouse. "Happy Birthday, bear!" the foxes say. "Thank you", the bear says, "Would you like some cake?"



“Nee,” zegt deze vos (links), “ik lust geen taart”. “En jij dan” vraagt de beer aan deze vos (midden). “Nee”, zegt de vos, “ik heb niet zo’n honger”. “En jij dan muis, jij lust vast wel een stukje taart”, zei de beer tegen de muis. “Nou,” zegt de muis, “Ik vind taart wel heel erg lekker, maar ik vind de stukken een beetje te groot, dus ik hoef ook geen taart”. “Nou,” zegt deze vos hier (rechts), “ik heb heel veel trek, ik lust alledrie de stukken wel”.
 “No,” this fox (the leftmost one) says, “I don’t like cake”. “How about you,” the bear asks this fox (the middle one). “No” the fox says, “I am not very hungry”. “How about you, mouse. I bet you want a piece”. “Well,” the mouse says, “I really like cake, but the pieces are too big for me, so I will not have any cake either”. “Well” his fox over here says (the rightmost one), “I am so hungry that I could eat all three pieces”.

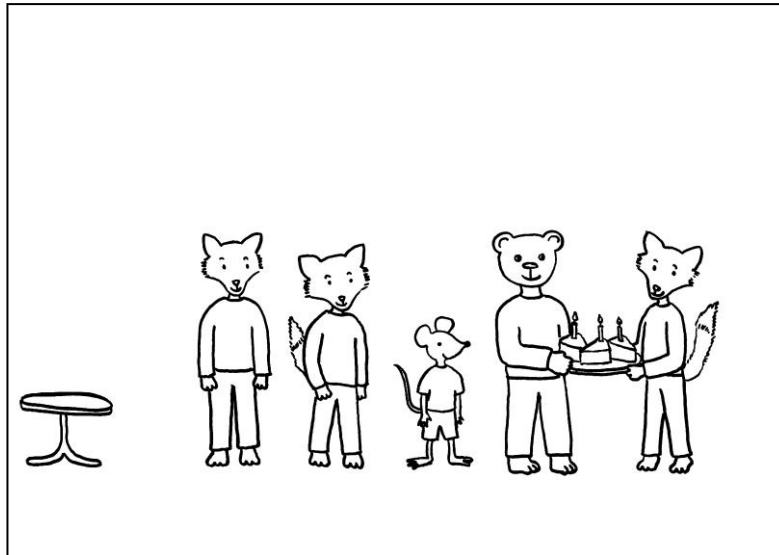

En dus gaf de beer hem de stukken taart.
 And so the bear gave him the pieces of cake.

Controls:

- **Elke vos draagt een blauwe trui** (Quantifier Control False).
- **Every fox is wearing a blue jumper** (QTF).
- **Er staat een kaarsje op elk stuk kaart** (Quantifier Control True).
- **There is a candle on each piece of cake** (QCT).

Experiment II:

- **The bear gave some fox every piece of cake** (DO-dat SOME).
- **The bear gave a fox every piece of cake** (DO-dat INDEF).

Experiment III:

- **De beer heeft één vos elk stuk taart gegeven** (DO-dat NUM).
- **The bear gave one fox every piece of cake** (DO-dat NUM).
- **De beer heeft elk stuk taart aan één vos gegeven** (PP-dat NUM).
- **The bear gave every piece of cake to a fox.**
- **De beer heeft aan één vos elk stuk taart gegeven** (SPP-dat NUM).
- **The bear gave to a fox every piece of cake.**

Experiment V:

- **De beer heeft een vos drie stukken taart gegeven** (DO-dat DRIE1).
- **The bear gave a fox three pieces of cake.**

- ***De beer heeft een vos ieder stuk taart gegeven*** (DO-dat IEDER1).
The bear gave a fox every piece of cake.

Experiment VI:

- ***De beer heeft een vos alle stukken taart gegeven*** (DO-dat ALLE1).
The bear gave a fox all pieces of cake.
- ***De beer heeft een vos ieder stuk taart gegeven*** (DO-dat IEDER1).
The bear gave a fox every piece of cake.

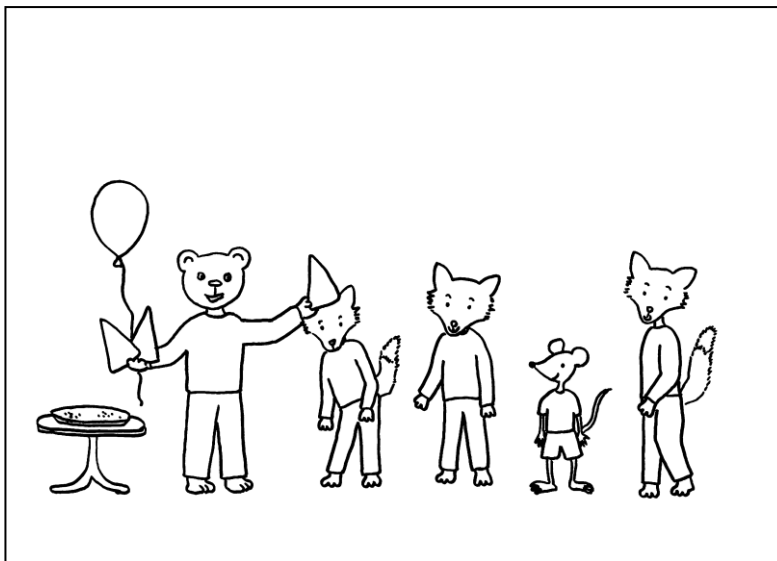

“Dankjewel” zegt de beer, “Ik wil jullie ook graag nog wat geven. Ik heb hier namelijk 3 feesthoedjes”. De beer zet eerst een hoedje op het hoofd van deze vos.

“I want to give you something as well,” the bear says. “Look, here I have three funny hats”. The bear first puts a hat on the head of this fox.

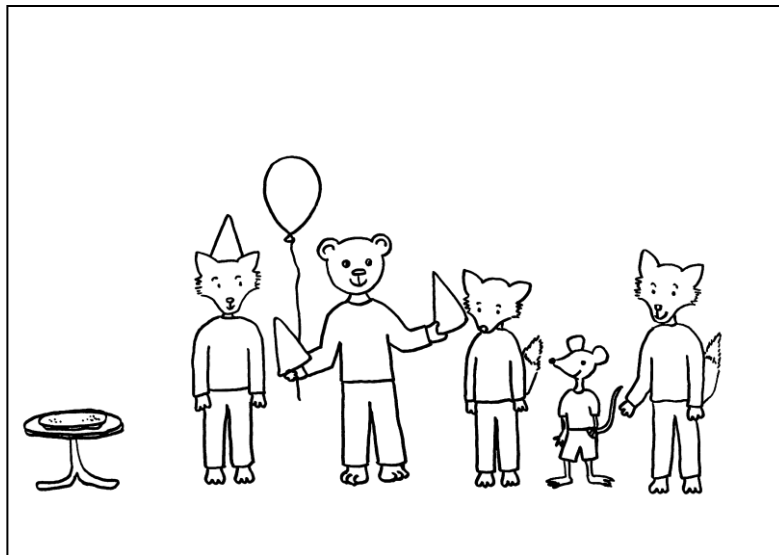

Dan geeft de beer een hoedje aan deze vos.
Then the bear gives this fox a hat.

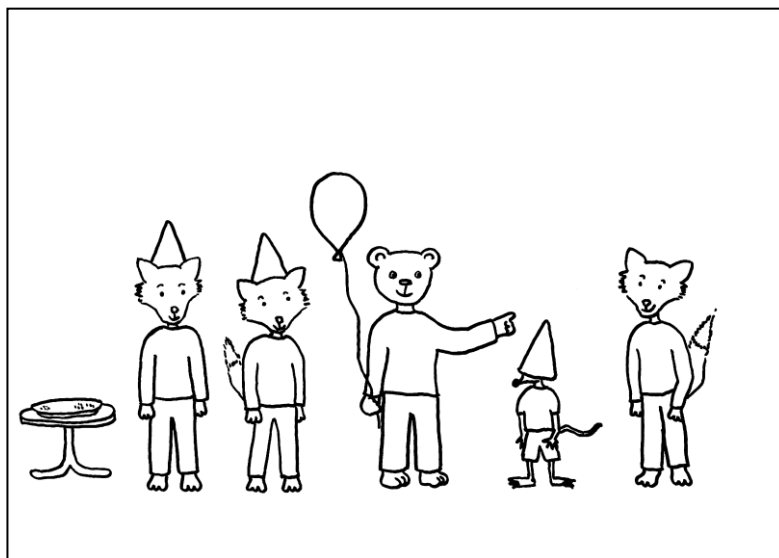

“Muis wil jij er ook een?, zegt de beer. “Ik denk dat hij te groot voor me is”, zegt de muis, “kijk maar! Mag ik in plaats van het hoedje een ballon hebben?”. “Natuurlijk”, zegt de beer, “En dan geef ik jou (wijst naar derde vos) dit hoedje”.

“Mouse, would you like one as well?”, the bear says. “I think it is too big for me”, the mouse says, “Look! Can I have a balloon instead?”. “Sure,” the bear says, “and then I will give you (points to third fox) this hat instead”.

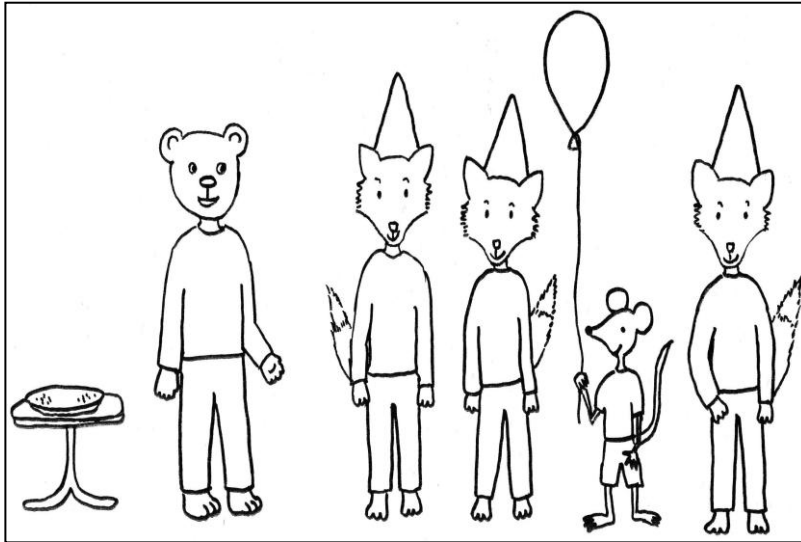

En dat gebeurde dan ook..
And that is what happened.

Controls:

- *Elk hoedje is geel* (Quantifier Control False).
- **Every little hat is yellow** (QCF).

Experiment II:

- **The bear gave some fox every hat** (DO-dat SOME).
- **The bear gave a fox every hat** (DO-dat INDEF).

Experiment III:

- *De beer heeft één vos elk hoedje gegeven* (DO-dat NUM).
- **The bear gave one fox every hat** (DO-dat NUM).
- *De beer heeft elk hoedje aan één vos gegeven* (PP-dat NUM).
- **The bear gave every hat to one fox.**
- *De beer heeft aan één vos elk hoedje gegeven* (SPP-dat NUM).
- **The bear gave to one fox every hat.**

Experiment V:

- *De beer heeft een vos drie hoedjes gegeven* (DO-dat DRIE1).
- **The bear gave a fox three hats.**
- *De beer heeft een vos ieder hoedje gegeven* (DO-dat IEDER1).
- **The bear gave a fox every hat.**

Experiment VI:

- *De beer heeft een vos alle hoedjes gegeven* (DO-dat ALLE1).
- **The bear gave a fox all hats.**
- *De beer heeft een vos ieder hoedje gegeven* (DO-dat IEDER1).
- **The bear gave a fox every hat.**

Name: 'Shop Story'
 Type: Dative (DO-dat, PP-dat)
 Predicate: *verkopen* 'to sell'
 Event order: ALL>ONE precedes ONE>ALL

Background: Three girls and a boy are invited to a party and decide to go and buy new clothes to wear to the party. They go the shop owned by a rabbit.

ALL>ONE event: The rabbit shows the children three dresses (a yellow one, a blue one and a green one). The rabbit sells one of the girls a yellow dress. The rabbit sells the second girl a blue dress. The rabbit tries to sell the boy a dress, but he refuses exclaiming that dresses are not for boys. The rabbit then sells his last (green) dress to the third girl. The boy buys a baseball cap.

Controls:

- **Elk meisje draagt een roze rokje.**
Each girl is wearing a pink skirt (Quantifier Control True).
- **Alle jurken zijn groen.**
All the dresses are green (Quantifier Control False).

Experiment II:

- **The rabbit sold some girl every dress** (DO-dat SOME).
- **The rabbit sold a girl every dress** (DO-dat INDEF).

Experiment III:

- **Het konijn heeft één meisje elke jurk verkocht** (DO-dat NUM).
- **The rabbit sold one girl every dress** (DO-dat NUM).
- *Het konijn heeft elke jurk aan één meisje verkocht* (PP-dat NUM).
- **The rabbit sold every dress to one girl.**

- ***Het konijn heeft aan één meisje elke jurk verkocht.***
(SPP-dat NUM)
The rabbit sold to one girl every dress.

Experiment V:

- ***Het konijn heeft een meisje drie jurken verkocht*** (DO-dat DRIE2).
The rabbit sold a girl three dresses.
- ***Het konijn heeft een meisje iedere jurk verkocht*** (DO-dat IEDER2).
The rabbit sold a girl every dress.

Experiment VI:

- ***Het konijn heeft een meisje alle jurken verkocht*** (DO-dat ALLE2).
The rabbit sold a girl all dresses.
- ***Het konijn heeft een meisje iedere jurk verkocht*** (DO-dat IEDER2).
The rabbit sold a girl every dress.

ONE>ALL event: The children decide that they should also buy presents to take to the party. The rabbit therefore shows the children three teddy bears. Two of the girls and the boy do not want to buy any of the teddy bears. However, the third girl likes them very much, and decides to buy all of them.

Controls:

- **Iedere teddybeer is bruin** (Quantifier Control True).
Every teddy bear is brown.

Experiment II:

- **The rabbit sold some girl every teddy bear** (DO-dat SOME)
- **The rabbit sold a girl every teddy bear** (DO-dat INDEF)

Experiment III:

- **Het konijn heeft één meisje elke teddybeer verkocht**
(DO-dat NUM).
- **The rabbit sold one girl every teddy bear** (DO-dat NUM).
- ***Het konijn heeft elke teddybeer aan één meisje verkocht***
(PP-dat NUM).
The rabbit sold every teddy bear to one girl.
- ***Het konijn heeft aan één meisje elke teddybeer verkocht***
(SPP-dat NUM).
The rabbit sold to one girl every teddy bear.

Experiment V:

- *Het konijn heeft een meisje drie teddyberen verkocht*
(DO-dat DRIE2)
- **The rabbit sold a girl three teddy bears.**
- *Het konijn heeft een meisje iedere teddybeer verkocht*
(DO-dat IEDER2).
- **The rabbit sold a girl every teddy bear.**

Experiment VI:

- *Het konijn heeft een meisje alle teddyberen verkocht*
(DO-dat ALLE2).
- **The rabbit sold a girl all the teddy bears.**
- *Het konijn heeft een meisje iedere teddybeer verkocht*
(DO-dat IEDER2).
- **The rabbit sold a girl every teddy bear.**

Name: 'Letters and Packages Story'
 Type: Dative (DO-dat, PP-dat)
 Predicate: *brenge* 'to bring'
 Event order: ONE>ALL precedes ALL>ONE

Background: A monkey opens his mailbox and finds three packages and three letters which are not addressed to him, but to others. He decides to bring them to the correct people.

ONE>ALL event: The monkey puts the packages in his wheelbarrow and goes on his way. He meets three ducks and a frog. Duck 1 asks the monkey whether one of the packages is for him, the monkey tells him it is not. Duck 2 also asks, but the monkey does not have any packages for him. The frog also wants to know whether the monkey is bringing him a package, but the monkey instead brings all three packages to the third duck.

Controls:

- **Iedere eend is wit** (Quantifier Control True).
Every duck is white.
- **Ieder pakje is rond** (Quantifier Control False).
Every package is round.

Experiment II:

- **The monkey brought some duck every package** (DO-dat SOME)
- **The monkey brought a duck every package** (DO-dat INDEF)

Experiment III:

- *De aap heeft één eend elk pakje gebracht* (DO-dat NUM).
- **The monkey brought one duck every package** (DO-dat NUM).
- *De aap heeft elk pakje naar één eend gebracht* (PP-dat NUM).
- **The monkey brought every package to one duck.**
- *De aap heeft naar één eend elke pakje gebracht* (SPP-dat NUM).
- **The monkey brought to one duck every package.**

Experiment V:

- *De aap heeft een eend drie pakjes gebracht* (DO-dat DRIE3).
- **The monkey brought a duck three packages.**
- *De aap heeft een eend elk pakje gebracht* (DO-dat IEDER3).
- **The monkey brought a duck every package.**

Experiment VI:

- *De aap heeft een eend alle pakjes gebracht* (DO-dat ALLE3).
- **The monkey brought a duck all the packages.**
- *De aap heeft een eend elk pakje gebracht* (DO-dat IEDER3).
- **The monkey brought a duck every package.**

ALL>ONE event: The monkey also has three letters he has to bring to the right animals. He goes home, puts them in the wheelbarrow and goes on his way. He then meets three mice and a rabbit. The monkey brings a letter to one of the mice. He then brings a letter to the second mouse. He apologizes to the rabbit for not bringing him a letter, but does bring a letter to the third mouse.

Controls:

- **Een muis draagt een hoed** (Indefinite control true).
- **Some mouse is wearing a hat.** (SOME-control true).
- **Elke brief zit in een blauwe envelop** (Quantifier Control).
- **Every letter has a blue envelope.**

Experiment II:

- **The monkey brought some mouse every letter** (DO-dat SOME).
- **The monkey brought a mouse every letter** (DO-dat INDEF).

Experiment III:

- **De aap heeft één muis elke brief gebracht** (DO-dat NUM).
- **The monkey brought one mouse every letter** (DO-dat NUM).
- *De aap heeft elke brief naar één muis gebracht* (PP-dat NUM).

The monkey brought every letter to one mouse.

- *De aap heeft naar één muis elke brief gebracht* (SPP-dat NUM).

The monkey brought to one mouse every letter.

Experiment V:

- *De aap heeft een muis drie brieven gebracht* (DO-dat DRIE3).
- **The monkey brought a mouse three letters.**
- *De aap heeft een muis iedere brief gebracht* (DO-dat IEDER3).
- **The monkey brought a mouse every letter.**

Experiment VI:

- *De aap heeft een muis alle brieven gebracht* (DO-dat ALLE3).
- **The monkey brought a mouse all the letters.**
- *De aap heeft een muis iedere brief gebracht* (DO-dat IEDER3).
- **The monkey brought a mouse every letter.**

Name: 'Zoo Story'
 Type: Dative (DO-dat, PP-dat)
 Predicate: *voeren* 'to feed'
 Event order: ALL>ONE precedes ONE>ALL

Background: This is a story about a girl who is at the zoo with her dog. In the zoo she sees three giraffes and a zebra. The girl brought three apples to feed to the animals.

Non-Prototypical Distributivity Full: The girl first feeds an apple to one of the giraffes. She then feeds an apple to the second giraffe. However, she notices that she does not have enough apples left to feed both the zebra and the third giraffe. The girl then feels her pocket to see whether it contains any other food, and in her pocket she finds a cookie. She feeds the zebra the cookie, and the third giraffe gets the last apple.

Controls:

- **Iedere giraffe heeft vlekken** (Quantifier Control True).
Every giraffe has spots.
- **Alle appels zijn groen** (Quantifier Control False).
All apples are green.
- **Elke aap is bruin** (Quantifier Control True).
Every monkey is brown

Experiment II:

- **The girl fed some giraffe every apple** (DO-dat SOME).
- **The girl fed a giraffe every apple** (DO-dat INDEF).

Experiment III¹¹⁵:

- **The girl fed one giraffe every apple** (DO-dat NUM).

Experiment V:

- *Het meisje heeft een giraffe drie appels gevoerd* (DO-dat DRIE4).
- **The girl fed a giraffe three apples.**
- *Het meisje heeft een giraffe iedere appel gevoerd* (DO-dat IEDER4).
- **The girl fed a giraffe every apple.**

Experiment VI:

- *Het meisje heeft een giraffe alle appels gevoerd* (DO-dat ALLE4).
- **The girl fed a giraffe all apples.**
- *Het meisje heeft een giraffe iedere appel gevoerd* (DO-dat IEDER4).
- **The girl fed a giraffe every apple.**

ALL>ONE event: In her basket the girl also has three bananas which she wants to feed to the monkeys. The girl and her dog come across three monkeys in a cage. The girl attempts to feed one of the monkeys, but the monkey does not like bananas and keeps his mouth shut. She then tries to feed another monkey, but he turns away from her. The girl decides that the monkeys do not like bananas and offers her dog a banana. However, the dog makes clear he does not want one. The third monkey does want bananas and attempts to catch the girl's attention. She then feeds the third monkey all of the bananas.

Controls:

- **Every monkey is brown** (Quantifier Control True).

Experiment II:

- **The girl fed some monkey every banana** (DO-dat SOME).
- **The girl fed a monkey every banana** (DO-dat INDEF).

¹¹⁵ Only the English-speaking participants of experiment III saw this test story.

Experiment III:

- **The girl fed one monkey every banana** (DO-dat NUM).

Experiment V:

- *Het meisje heeft een aap drie bananen gevoerd* (DO-dat DRIE4).
- **The girl fed a monkey three bananas.**
- *Het meisje heeft een aap iedere banaan gevoerd* (DO-dat IEDER4).
- **The girl fed a monkey every banana.**

Experiment VI:

- *Het meisje heeft een aap alle bananen gevoerd* (DO-dat ALLE4)
- **The girl fed a monkey all bananas.**
- *Het meisje heeft een aap drie bananen gevoerd* (DO-dat DRIE4)
- **The girl fed a monkey three bananas.**

Appendix 4:***Story experiment IV***

Name: 'Jumping Story'
 Type: Transitive sentence: TWO-CAT and ONE-CAT conditions.
 Predicate: *springen* 'to jump'

Part 1:

Three cats and a dog are playing in the garden. The garden contains a rock, a fence and a pond. One of the cats boasts that he can jump really high and very far. The other cats and the dog state that they are very good at jumping as well. They decide to hold a jumping match to see who can jump the best. One of the cats boasts he can jump over the rock, and makes it. A second cat states that he can do better. He starts by jumping over the rock as well. He then declares that he is not tired yet, and proceeds by jumping over the fence.

Test and Control Statements:

- *Een kat sprong over het hek* (Indefinite control 1).
A cat jumped over the fence.
- *Een kat is twee keer over de steen gesprongen* (TWO-CAT).
a cat is two times over the rock jumped
'A cat jumped over the rock twice'

Part 2:

The dog boasts that he can jump over the pond, and does. The third cat trumps him by jumping over the pond not once, but twice.

Test Statement:

- *Een kat is twee keer over de vijver gesprongen* (ONE-CAT).
a cat is two times over the pond jumped
'A cat jumped over the pond twice'.

Appendix 5:

Sample materials experiment VII

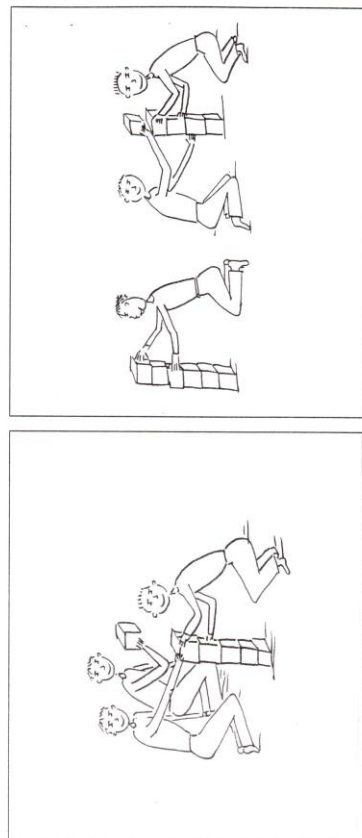

Elke jongen speelt met blokken.

Appendix 6:***Stories experiment VIII***

Name: 'Balloons'
 Type: Transitive Sentence, TPD and TC-conditions
 Predicate: *vasthouden* 'to hold'

Partially Distributive Event: Three girls and a boy are at the circus, where they run into a clown. The clown has two balloons, two large sticks of cotton candy/candy floss and a large lollipop. The clown gives the girls the balloons. Two of the girls are holding a balloon together, while the third girl has her own balloon.

Test statement:

- *Elk meisje houdt een ballon vast* (TPD).
every girl holds a balloon tight.
'Every girl is holding a balloon'.

Non-Distributive Event: Suddenly there is a strong gust of wind which blows the balloons away. The clown tries to console the children by offering the girls the cotton candy and the boy the lollipop. The girls end up holding the cotton candy together.

Test statement:

- *Elk meisje houdt een suikerspin vast* (TC).
every girl holds (a) cotton candy tight
'Every girl is holding cotton candy'.

Name: 'Zoo-story' version A
 Type: Dative Sentence (DO-dat), NPDE and ES1-conditions.
 Predicate: *voeren* 'to feed', *geven* 'to give'.

Background:

This is a story about a girl who is at the zoo with her dog. In the zoo she sees three giraffes and a zebra. The girl brought three apples to feed to the animals.

Non-Prototypical Distributivity Extra: The girl first feeds an apple to one of the giraffes. She then feeds an apple to the second giraffe. However, she notices that she does not have enough apples left to feed both the zebra and the third giraffe. The girl then feels her pocket to see whether it contains any other food, and in her pocket she finds two cookies. She feeds one of the cookies to the zebra. Then she wants to feed the last apple to the third giraffe, but he wants a cookie as well. The girl thus feeds the third giraffe the cookie, and one of the other giraffes gets another apple.

Test and Control Statements:

- *Elke appel is rood* (Quantifier Control True).
Every apple is red.
- *Het meisje heeft een giraffe elke appel gevoerd* (NPDE1).
The girl fed a giraffe every apple.

ONE>ALL-type event (ES1): In her basket the girl also has three bananas which she wants to feed to the monkeys. The girl and her dog come across three monkeys in a cage. The girl attempts to feed one of the monkeys, but the monkey does not like bananas and keeps his mouth shut. She then tries to feed another monkey, but he turns away from her. The girl decides that the monkeys do not like bananas and offers her dog a banana. However, the dog makes clear he does not want one. The third monkey does want bananas and attempts to catch the girl's attention. She then feeds the third monkey one of the bananas. The monkey makes clear that he can eat more, and gets a second banana, and then finally also gets the third banana.

Test and Control Statements:

- *Elke aap is bruin* (QCT).
Every monkey is brown.
- *Het meisje heeft een aap elke banaan gegeven* (ES1-1).
The girl gave a monkey every banana.

Name: 'Zoo-story' version B
 Type: Dative Sentence (DO-dat), NPDE and ES2-conditions.
 Predicate: *voeren* 'to feed', *geven* 'to give'.

Background:

This is a story about a girl who is at the zoo with her dog. In the zoo she sees three giraffes and a zebra. The girl brought four apples to feed to the animals.

Non-Prototypical Distributivity Full: The girl first feeds an apple to one of the giraffes. She then feeds two apples to the second giraffe. However, she notices that she does not have enough apples left to feed both the zebra and the third giraffe. The girl then feels her pocket to see whether it contains any other food, and in her pocket she finds a cookie. She feeds the zebra the cookie, and the third giraffe gets the last apple.

Test and Control Statements:

- *Elke appel is rood* (QCT).
Every apple is red.
- *Het meisje heeft een giraffe elke appel gevoerd* (NPDF1).
The girl fed a giraffe every apple.

ONE>ALL type event (ES2): In her basket the girl also has three bananas which she wants to feed to the monkeys. The girl and her dog come across three monkeys in a cage. The girl attempts to feed one of the monkeys, but the monkey does not like bananas and keeps his mouth shut. She then tries to feed another monkey, but he turns away from her. The girl decides that the monkeys do not like bananas and offers her dog a banana. However, the dog makes clear he does not want one. The third monkey does want bananas and attempts to catch the girl's attention. She then feeds the third monkey "This banana, and this banana and this banana". (Recall that for the ES2-condition the banana-giving events were individuated in the story, but not in the accompanying pictures).

Test and Control Statements:

- *Elke aap is bruin* (QCT).
Every monkey is brown.
- *Het meisje heeft een aap elke banaan gegeven* (ES2-1).
The girl gave a monkey every banana.

Name: 'Birthday-story' version A
Type: Dative Sentence (DO-dat), ES1 and DAO conditions.
Predicate: *geven* 'to give'.

Background: In a very large forest there lives a bear, and today he is celebrating his birthday. For that reason, he is having a party. The bear has invited all of his friends: three foxes and a mouse. After his friends

congratulate him on his birthday, the bear offers them some cake. He has three pieces of cake (each of the pieces of cake is on a separate plate).

ONE>ALL-type event (ES1): The first fox declines because he does not like cake. The second fox declines because he is not hungry. The bear then offers the mouse a piece of cake, but the mouse states that the pieces are too big for him and declines as well. The third fox states that he is very hungry and would love some cake. The bear then gives him one of the pieces of cake. The fox then declares that he could eat more than one piece of cake. The bear concedes and gives him a second piece of cake. The fox then boasts that he could eat the last piece of cake as well. The bear consequently also gives him the last piece of cake.

Test and Control Statements:

- *Er staat een kaarsje op elk stuk taart* (QCT).
There is a candle on every piece of cake.
- *Elke vos draagt een blauwe trui* (QCF).
Every fox is wearing a blue jumper.
- *De beer heeft een vos elk stuk taart gegeven* (ES1-2).
The bear gave a fox every piece of cake.

All>One event: The bear also has three party hats and a balloon and he wants to give them to his friends. He puts one of the hats on the head of one of the foxes. Then he gives another fox one of the hats. He asks whether the mouse also wants one. The mouse replies that he would love one, but that he thinks the hat would be too big for him. He tries it on and it is indeed too big. The mouse then gets the balloon, and the third fox gets the last party hat.

Test and Control Statements:

- *Ieder hoedje is rood* (QCF).
Every little hat is red.
- *De beer heeft een vos elk hoedje gegeven* (DAO).
The bear gave a fox every hat.

Name: 'Birthday-story' version B
Type: Dative Sentence (DO-dat), ES1 and DAO-conditions.
Predicate: *geven* 'to give'.

Background: In a very large forest there lives a bear, and today he is celebrating his birthday. For that reason, he is having a party. The bear has invited all of his friends: three foxes and a mouse. After his friends

congratulate him on his birthday, the bear offers them some cake. He holds three pieces of cake on a large plate.

ONE>ALL-type event (ES2): The first fox declines because he does not like cake. The second fox declines because he is not hungry. The bear then offers the mouse a piece of cake, but the mouse states that the pieces are too big for him and declines as well. The third fox states that he is very hungry and boasts that he could eat all of the pieces of cake. The bear then gives him: “This piece of cake, and this piece of cake, and this piece of cake”. (Recall that for the ES2-condition the cake-giving events were individuated in the story, but not in the accompanying pictures).

Test and Control Statements:

- *Er staat een kaarsje op elk stuk taart* (QCT).
There is a candle on every piece of cake.
- *Elke vos draagt een blauwe trui* (QCF).
Every fox is wearing a blue jumper.
- *De beer heeft een vos elk stuk taart gegeven* (ES2-2).
The bear gave a fox every piece of cake.

All>One event: The bear also has three party hats and a balloon and he wants to give them to his friends. He puts one of the hats on the head of one of the foxes. Then he gives another fox one of the hats. He asks whether the mouse also wants one. The mouse replies that he would love one, but that he thinks the hat would be too big for him. He tries it on and it is indeed too big. The mouse then gets the balloon, and the third fox gets the last party hat.

Test and Control Statements:

- *Ieder hoedje is rood* (QCF).
Every little hat is red.
- *De beer heeft een vos elk hoedje gegeven* (DAO).
The bear gave a fox every hat.

Name: ‘Packages and Letters-story’ version A
Type: Dative Sentence (DO-dat), DOA and NPDE-conditions.
Predicate: *brenge* ‘to bring’.

Background: A monkey opens his mailbox and finds three packages and three letters which are not addressed to him, but to others. He decides to bring them to the correct people.

ONE>ALL event: The monkey puts the packages in his wheelbarrow and goes on his way. He meets three ducks and a frog. Duck 1 asks the monkey whether one of the packages is for him, the monkey tells him it is not. Duck 2 also asks, but the monkey does not have any packages for him. The frog also wants to know whether the monkey is bringing him a package, but the monkey instead brings all three packages to the third duck.

- *Elke eend draagt een blauw jasje* (QCT).
Every duck wears a blue jacket.
- *Ieder pakje is rond* (QCF).
Every package is round.
- *De aap heeft een eend elk pakje gebracht* (DOA).
The monkey brought a duck every package.

Non-Prototypical Distributivity Extra: The monkey also has four letters he has to bring to the right animals. He goes home, puts them in the wheelbarrow and goes on his way. He then meets three mice and a rabbit. The monkey brings a letter to one of the mice. He apologizes to both the rabbit and the second mouse for not bringing them a letter. Since the rabbit and the second mouse look very sad, the monkey tries to console them by picking a flower for each of them. He then brings two letters to the third mouse.

Test and Control Statements:

- *Iedere brief zit in een blauwe envelop* (QCT).
Every letter has a blue envelope.
- *De aap heeft een muis elke brief gebracht* (NPDE2).
The monkey brought a mouse every letter

Name: 'Packages and Letters-story' version B
 Type: Dative Sentence (DO-dat), DOA and NPDE-conditions.
 Predicate: *brengen* 'to bring'.

Background: A monkey opens his mailbox and finds three packages and three letters which are not addressed to him, but to others. He decides to bring them to the correct people.

ONE>ALL event: The monkey puts the packages in his wheelbarrow and goes on his way. He meets three ducks and a frog. Duck 1 asks the monkey whether one of the packages is for him, the monkey tells him it is not. Duck

2 also asks, but the monkey does not have any packages for him. The frog also wants to know whether the monkey is bringing him a package, but the monkey instead brings all three packages to the third duck.

- *Elke eend draagt een blauw jasje* (QCT).
Every duck wears a blue jacket.
- *Ieder pakje is rond* (QCF).
Every package is round.
- *De aap heeft een eend elk pakje gebracht* (DOA).
The monkey brought a duck every package.

Non-Prototypical Distributivity Full: The monkey also has four letters he has to bring to the right animals. He goes home, puts them in the wheelbarrow and goes on his way. He then meets three mice and a rabbit. The monkey brings a letter to one of the mice. He then brings two letters to another mouse. He apologizes to the rabbit for not bringing him a letter, but does bring a letter to the third mouse.

Test and Control Statements:

- *Iedere brief zit in een blauwe envelop* (QCT).
Every letter has a blue envelope.
- *De aap heeft een muis elke brief gebracht* (NPDF2).
The monkey brought a mouse every letter

Appendix 7:**Individual Performance Patterns Experiment VIII**

DOA/ DAO	N	NPDE	N	ES1	N	TPD	N	TC	N
Reverse Pattern	11	false	11	false	9	true	10	true	9
				mixed	2	false	1	false	2
Ambiguity Pattern	7	false	3	false	1	true	7	true	7
		mixed	2	mixed	3				
		true	2	true	3				
Target-like	3	false	1	true	3	true	2	true	2
		mixed	1			false	1	false	1
		true	1						
Other (not completed or both false)	3	false	2	false	1	true	3	true	2
		mixed	1	mixed	2			false	1

Table 1: Full Individual Patterns Children Book 1

DOA/ DAO	N	NPD F	N	ES2	N	TPD	N	TC	N
Reverse Pattern	12	true	11	false	12	true	9	true	8
		mixed	1			false	3	false	4
Ambiguity Pattern	1	mixed	1	true	1	true	1	true	1
Target-like	3	false	1	false	1	true	2	true	1
		mixed	1	true	2	false	1	false	2
		true	1						
Other (not completed or both false)	1	true	1	false	1	false	1	false	1

Table 2: Full Individual Patterns Children Book 2

DOA/DAO	N	NPDE	N	ES1	N	TPD	N	TC	N
Reverse Pattern	3	true	1	true	1	true	2	true	2
		false	2	false	1	false	1	false	1
Ambiguity Pattern	2	true	2	true	2	true	2	true	2
Target-like	9	true	1	true	9	true	2	true	4
		false	8			false	7	false	5

Table 3: Individual Response Patterns Adults Book 1

DOA/DAO	N	NPDE	N	ES2	N	TPD	N	TC	N
Reverse Pattern	3	true	3	true	2	false	3	true	1
		false		false	1			false	2
Ambiguity Pattern	4	true	2	true	2	true	3	true	1
		false	2	mixed	2	false	1	false	3
Target-like	10	false	1	true	10	true	5	true	4
			0			false	5	false	6

Table 4: Individual Response Patterns Adults Book 2

Appendix 8:

The Data

General notes

- In all cases m= male and f= female.
- All child ages are presented in years; months, and are rounded off to whole months.
- All ages of adult participants are rounded off to whole years.
- When a participant judges a sentence to be true, this is coded as 'yes'.
- When a participant judges a sentence to be false, this is coded as 'no'.
- When a participant failed to judge a test item, then this is indicated as '--'.
- When a participant failed to judge a control item, this is counted as a mistake.
- Filler-items are not included in the tables.
- More information is available above each of the tables.

Chapter 2: Experiment 1

In experiment 1 all children were presented with a number of control conditions:

Quantifier-control True (QT), 5 trials.

Irrelevant-control False (QF), 6 trials.

Dative Controls True (DT) (= appendix 1: control DO-dat, control PP-dat, control SPP-dat), 3 trials.

Dative Controls False (DF) (=appendix 1: control DO-dat, control PP-dat, control SPP-dat), 3 trials.

The table below gives the total number of correct responses for each of the test conditions. When children failed to judge one of the control conditions, this was counted as a mistake.

All participants were presented with a transitive sentence with an indefinite object and universally quantified direct object in both a ONE>ALL event (ISOA) and an ALL>ONE event (ISAO).

Furthermore, about one-third were presented with DO-dat construction (see tables 1 and 4), one-third saw the PP-dat construction (tables 2 and 5) and one-third saw the SPP-dat construction (tables 3 and 6).

Book 1: ONE> ALL preceded ALL>ONE in the 'Birthday'-story and the 'Letters and Packages'-story, and followed ALL>ONE in the 'Shop'-story.

Book 2: ALL>ONE preceded ONE>ALL in the 'Birthday'-story and the 'Letters and Packages'-story and followed ONE>ALL in the 'Shop'-story.

Within these two main versions there were three possible orderings, leading to 6 distinct versions:

Version 1 = Book 1, Birthday> Shop> Letters.

Version 2= Book 1, Shop> Letters> Birthday

Version 3= Book 1, Letters> Birthday> Shop

Version 4= Book 2, Birthday> Shop> Letters.

Version 5= Book 2, Shop> Letters> Birthday

Version 6= Book 2, Letters> Birthday> Shop

nr	age	gen	vers	qt(n)	qf(n)	dt(n)	df(n)	isao	isao	doa1	doa2	doa3	dao1	dao2	dao3
1	5;10	m	1	5	6	3	3	yes	no	yes	yes	yes	no	no	no
2	6;1	m	4	5	6	3	2	yes	no	no	no	no	yes	yes	no
3	5;10	f	2	4	6	3	3	--	no	no	no	no	yes	yes	yes
4	4;3	m	2	3	4	1	2	--	no	no	--	no	yes	--	yes
5	5;5	f	5	5	6	3	3	yes	no	yes	yes	yes	no	no	no
6	5;8	m	3	5	4	2	2	yes	yes	no	yes	no	yes	yes	no
7	6;9	m	6	5	6	2	3	yes	yes	no	no	no	yes	yes	yes
8	5;4	m	1	5	6	3	3	yes	no	no	yes	yes	--	yes	no
9	5;7	f	4	5	6	3	3	yes	yes	no	no	no	yes	yes	yes
10	5;0	m	2	5	6	3	3	no	no	yes	no	no	no	yes	yes
11	6;1	f	5	5	6	3	3	yes	yes	no	no	no	yes	yes	yes
12	5;9	f	3	5	6	3	3	yes	yes	no	yes	yes	yes	yes	yes
13	4;11	f	6	5	6	3	3	no	yes	no	no	no	yes	yes	yes

Table 1: Performance Child Participants Experiment I, DO-dat.

nr	age	gen	vers	qt(n)	qt(n)	dt(n)	df(n)	isao	isao	ppoa1	ppoa2	ppoa3	ppao1	ppao2	ppao3
1	5;1	f	1	5	5	3	3	--	--	no	yes	yes	yes	yes	yes
2	5;11	m	2	5	6	3	2	yes	yes	yes	yes	yes	yes	yes	yes
3	6;2	f	4	5	6	3	3	yes	no	yes	yes	no	yes	no	yes
4	4;10	m	5	5	6	3	3	no	yes	no	yes	yes	yes	yes	yes
5	6;10	m	3	5	6	3	3	no	yes	yes	yes	no	yes	yes	yes
6	4;11	m	6	5	6	3	3	no	yes	no	no	no	yes	yes	yes
7	4;5	f	1	5	3	3	3	no	no	yes	yes	yes	yes	yes	yes
8	4;11	f	4	5	6	3	3	--	yes	no	no	no	yes	yes	yes
9	5;3	m	2	5	6	3	3	yes	no	no	no	no	yes	yes	yes
10	5;8	f	5	5	5	3	3	yes	no	no	no	no	yes	yes	yes
11	6;1	f	3	5	6	3	3	yes	yes	yes	yes	yes	yes	yes	yes
12	6;1	m	6	5	6	3	3	no	yes	no	yes	no	yes	yes	yes
13	6;1	m	1	5	6	3	3	no	no	no	no	no	yes	yes	yes

Table 2: Performance Child Participants Experiment I, PP-dat.

nr	age	gen	vers	qt(n)	qf(n)	dtr(n)	df(n)	isao	isao	spoa1	spoa2	spoa3	spao1	spao2	spao3
1	5;7	m	1	5	3	3	3	yes	no	no	yes	yes	no	no	yes
2	5;3	m	2	5	6	3	3	no	no	yes	no	no	yes	yes	yes
3	4;8	f	2	5	6	3	3	yes	yes	no	no	no	yes	yes	yes
4	5;10	m	4	5	6	3	3	yes	no	no	yes	yes	no	no	no
5	4;5	m	5	5	4	3	3	yes	yes	yes	yes	no	no	no	no
6	5;8	m	3	5	6	2	2	no	yes	no	no	no	yes	yes	yes
7	5;3	m	6	5	6	2	3	no	yes	no	no	no	yes	yes	yes
8	4;8	f	1	5	6	3	2	no	yes	no	yes	no	yes	yes	yes
9	4;11	m	4	5	6	3	3	no	yes	no	yes	no	yes	yes	yes
10	5;0	f	2	5	6	3	3	no	yes	no	yes	yes	no	yes	yes
11	6;1	m	5	5	6	3	3	yes	yes	no	yes	no	yes	yes	yes
12	6;2	m	3	5	6	3	3	yes	no	yes	yes	yes	no	no	no
13	6;0	f	6	5	6	3	3	no	no	no	no	no	yes	yes	yes
14	4;8	f	1	5	6	2	3	no	yes	yes	yes	yes	yes	yes	yes

Table 3: Performance Child Participants Experiment I, SPP-dat.

nr	age	gen	vers	contr.	qt(n)	qf(n)	dt(n)	df(n)	isao	isao	doa1	doa2	doa3	dao1	dao2	dao3
1	19	m	1	DO	5	6	3	3	no	yes	no	no	no	yes	yes	yes
2	22	f	5	DO	5	6	3	3	yes	no	yes	yes	yes	no	no	no
3	50	m	6	PP	5	6	3	3	yes	no	yes	yes	yes	yes	yes	yes
4	26	m	6	DO	5	6	3	3	yes	no	yes	yes	yes	no	no	no
5	41	m	6	SPP	5	6	3	3	yes	no	no	no	no	yes	yes	yes
6	48	f	5	PP	5	6	3	3	yes	no	yes	no	yes	yes	yes	yes
7	23	f	4	SPP	5	6	3	3	yes	no	no	no	no	yes	yes	yes
8	27	m	4	DO	5	6	3	3	no	yes	no	yes	no	yes	no	no
9	23	m	4	PP	5	6	2	3	yes	no	no	no	no	yes	yes	yes
10	47	m	5	SPP	5	6	3	3	yes	no	no	yes	no	yes	yes	yes

Table 4: Performance Adult Participants Experiment I.

Chapter 3: Experiment II

-English-speaking children saw two trials of each of the SOM(E)-conditions, and one trial of each of the IND(EF)-conditions. In addition, these children saw six trials of each of the quantifier control conditions (QF and QT) and two trials of each of the indefinite control conditions (ICF and ICT).

Version 1: Birthday>shop> letters and packages.

Version 2: Shop> letters and packages> zoo.

Version 3: Letters and packages> zoo> birthday

Version 4: Zoo> birthday> shop.

-English-speaking adults only saw one trial of the SOME- and INDEF-conditions. In addition, they saw two trials of the QF and the QT-conditions.

nr	age	gen	vers	qt(n)	qf(n)	icf(n)	ict(n)	someoa1	somaoa2	somao1	somao2	indoa	inao
1	4;9	f	1	4	3	2	2	yes	yes	yes	yes	yes	yes
2	4;9	f	1	5	6	1	2	yes	no	yes	yes	yes	no
3	5;0	m	2	5	4	1	1	yes	yes	yes	no	no	yes
4	4;9	f	3	6	5	2	1	yes	yes	yes	yes	--	yes
5	4;10	f	4	5	6	2	0	yes	no	no	yes	yes	--
6	3;9	f	1	6	6	2	2	no	yes	no	no	yes	yes
7	5;0	f	1	6	6	2	2	yes	yes	yes	no	no	yes
8	4;6	f	1	5	6	2	2	yes	no	yes	yes	yes	yes
9	4;11	f	1	6	6	1	2	yes	no	no	yes	yes	no
10	4;3	f	1	6	6	2	2	yes	yes	yes	yes	no	yes
11	4;11	f	2	6	6	1	2	no	no	no	yes	no	no
12	5;1	m	2	5	5	0	1	no	yes	no	yes	yes	yes
13	4;6	f	2	6	6	2	2	no	no	yes	yes	yes	no
14	5;10	m	2	6	6	2	1	no	no	yes	yes	yes	no
15	5;4	f	2	6	6	2	2	yes	no	yes	yes	no	yes
16	4;10	m	2	6	6	2	1	no	no	yes	yes	yes	no
17	4;3	f	3	6	6	2	2	no	yes	yes	no	yes	yes
18	5;8	m	3	5	6	2	1	no	no	yes	yes	no	yes
19	5;4	f	3	3	3	2	2	no	no	yes	no	--	--
20	4;1	f	3	6	6	2	2	no	no	no	no	yes	no
21	5;3	m	3	6	6	2	2	no	no	yes	no	yes	yes

nr	age	gen	vers	qt(n)	qf(n)	icf(n)	ict(n)	someoa1	somoa2	somao1	somao2	indoa	inao
22	4;5	m	4	3	5	0	2	yes	yes	yes	no	yes	yes
23	3;11	m	4	5	6	2	2	yes	no	no	yes	yes	yes
24	5;10	m	4	3	6	2	1	no	no	no	yes	yes	yes
25	4;4	m	4	5	5	2	1	yes	no	no	no	no	yes
26	5;4	m	4	6	6	2	1	no	yes	yes	no	no	yes
27	4;9	f	4	4	6	0	1	yes	no	no	yes	yes	yes
28	5;4	f	4	6	6	2	2	yes	yes	no	yes	yes	yes

Table 5: Results Child Participants Experiment II.

nr	age	gen	qt(n)	qf(n)	somoa1	someoa1	indoa	indao
1	f	19	2	2	yes	yes	yes	yes
2	f	19	2	2	yes	no	yes	no
3	f	19	2	2	yes	yes	yes	no
4	m	21	2	2	yes	yes	yes	no
5	m	24	2	2	yes	no	yes	yes
6	f	22	2	2	yes	yes	yes	no
7	m	18	2	2	yes	no	yes	no
8	f	20	2	1	no	yes	yes	yes

Table 6: Results Adult Participants Experiment II.

Chapter 3: Experiment III

For the Dutch children the design was the same as Experiment I. See the key above table 1 for more information. The English-speaking children only saw a single dative story. They saw two false control items (QF) and two true control items (QT). The Dutch-speaking adults saw three dative stories, but were only tested on the DO-dat construction. The adults saw four false control items (QF) and six true control items (QT).

nr.	age	gen	vers.	qt(n)	qt(f)	dt(n)	df(n)	numoa1	numoa2	numoa3	numao1	numao2	numao3
1	6;6	m	5	4	1	3	2	yes	yes	yes	yes	yes	yes
2	5;4	f	3	5	6	--	--	yes	--	yes	yes	yes	no
3	5;10	f	6	5	6	3	2	yes	yes	yes	no	no	no
4	5;8	f	1	5	6	3	3	yes	yes	yes	no	no	no
5	4;6	m	5	2	1	1	0	--	yes	--	--	yes	--
6	6	f	2	5	6	3	2	yes	yes	yes	yes	no	no
7	5;4	f	4	5	6	3	2	yes	no	yes	no	yes	yes

Table 7: Results Dutch Child Participants Experiment III, DO-dat.

nr.	age	gen	vers	qt(n)	qf(n)	dt(n)	(df(n))	numoa1	numoa2	numoa3	numao1	numao2	numao3
1	4;5	f	4	4	6	1	3	yes	yes	yes	no	no	no
2	5;0	f	2	3	5	2	3	yes	yes	yes	no	no	yes
3	6;0	f	5	5	6	3	2	yes	no	yes	no	no	no
4	5;1	f	3	5	6	3	3	no	no	no	yes	yes	no
5	5;0	m	6	5	6	3	3	no	yes	yes	no	no	no
6	4;4	f	2	0	1	0	1	--	yes	--	--	yes	--
7	5;4	f	4	5	6	3	3	yes	yes	yes	no	no	no
8	4;4	m	1	5	4	3	2	yes	yes	yes	yes	yes	yes

Table 8: Results Dutch Child Participants Experiment III, PP-dat.

nr.	age	gen	vers	qt(n)	qf(n)	dt(n)	(df(n))	numoa1	numoa2	numoa3	numao1	numao2	numao3
1	6;5	m	4	5	6	3	3	yes	yes	yes	no	no	no
2	5;6	m	2	5	6	3	3	no	yes	no	no	yes	no
3	6;7	f	5	5	6	3	3	yes	yes	yes	yes	no	yes
4	5;6	m	3	5	6	3	3	no	yes	no	yes	yes	yes
5	6;10	m	6	5	6	3	2	yes	yes	yes	yes	no	no
6	4;11	f	2	5	6	3	2	yes	yes	yes	no	no	no
7	4;10	f	4	5	6	3	3	no	yes	no	yes	no	no
8	4;3	m	1	5	6	3	2	yes	yes	yes	yes	yes	yes

Table 9: Results Dutch Child Participants Experiment III, SPP-dat.

nr.	age	gen	vers	qt(n)	qf(n)	dt(n)	(dif(n))	numoa1	numoa2	numoa3	numao1
1	25	f	1	6	4	yes	yes	yes	no	no	no
2	19	f	1	6	4	yes	yes	yes	no	no	no
3	26	m	1	6	4	yes	yes	yes	no	no	no
4	16	m	1	6	4	no	yes	yes	no	no	no
5	45	m	1	6	4	no	yes	yes	no	no	no
6	21	f	1	6	4	yes	yes	yes	no	no	no
7	19	f	1	6	4	yes	yes	yes	no	no	no

Table 10: Results Dutch Adult Participants Experiment III, DO-dat.

nr	age	gen	qt(n)	qf(n)	numoa	numao
1	4;9	f	1	0	yes	yes
2	4;9	f	2	2	yes	yes
3	4;9	f	1	1	no	no
4	4;10	f	2	1	yes	no
5	3;9	f	2	2	no	no
6	5;0	f	2	2	no	no
7	4;6	f	2	2	yes	yes
8	4;11	f	2	2	yes	yes
9	4;3	f	2	2	no	no
10	4;11	f	2	2	no	yes
11	5;1	m	2	2	yes	yes
12	4;6	f	2	1	no	yes
13	5;10	m	2	2	no	yes
14	5;4	f	2	2	yes	yes
15	4;10	m	2	2	no	yes
16	4;3	f	2	2	no	no
17	5;8	m	2	2	yes	yes
18	4;1	f	1	2	yes	yes
19	5;3	m	0	1	yes	yes
20	4;5	m	2	2	yes	no
21	3;11	m	2	2	no	no
22	5;10	m	2	2	no	no

nr	age	gen	qt(n)	qf(n)	numoa	numao
23	4;4	m	1	2	no	yes
24	5;4	m	1	2	yes	yes
25	4;9	f	2	1	yes	no
26	5;4	f	2	2	yes	yes
27	5;4	m	2	2	yes	no
28	4;2	f	2	2	no	yes
29	4;6	f	2	2	yes	yes
30	4;8	m	2	2	yes	yes
31	4;9	f	2	2	yes	no
32	4;6	m	2	2	yes	no
33	4;7	f	2	2	no	yes
34	5;0	m	2	2	yes	yes
35	4;0	m	2	2	yes	no
36	4;0	m	2	2	yes	no

Table 11: Results English-Speaking Child Participants Experiment III

Chapter III: Experiment IV

INDEF1 and INDEF2 were both control conditions. The target-response for both of them was 'yes'. The two test conditions were TWO-CAT (two cats jumped over a fence) or ONE-CAT (one cat jumped over a fence twice).

nr	age	gen	indef1	indef2	two-cat	one-cat
1	5;2	m	yes	yes	yes	yes
2	5;11	f	yes	yes	yes	yes
3	6;5	f	yes	yes	no	yes
4	6;1	f	yes	yes	no	yes
5	5;10	f	yes	yes	no	yes
6	6;3	f	yes	yes	no	yes
7	6;2	f	yes	yes	no	no
8	6;4	m	yes	yes	no	yes
9	6;2	m	yes	yes	no	yes
10	5;4	f	yes	no	no	yes
11	5;2	f	yes	yes	no	yes
12	5;1	m	yes	yes	yes	yes
13	4;0	m	yes	yes	yes	yes
14	5;0	f	yes	no	no	yes
15	5;1	f	yes	yes	no	yes
16	4;1	f	yes	no	yes	yes
17	6;1	m	yes	yes	yes	yes

nr	age	gen	indef1	indef2	two-cat	one-cat
18	5;0	f	yes	yes	no	yes
19	6;7	f	yes	yes	no	yes
20	5;9	m	yes	yes	no	yes
21	6;0	m	yes	yes	no	yes
22	5;4	m	yes	yes	no	yes
23	5;1	m	yes	yes	no	yes
24	5;8	m	yes	--	no	yes
25	6;2	f	yes	yes	no	yes
26	6;6	m	yes	yes	no	yes
27	6;6	f	yes	yes	no	yes
28	5;10	m	yes	yes	no	yes
29	5;4	f	yes	yes	no	yes
30	5	f	yes	yes	yes	yes
31	6;6	f	yes	yes	no	yes
32	5;11	f	yes	yes	no	yes
33	5;9	f	yes	yes	no	no
34	4;8	m	yes	yes	no	yes
35	4;7	m	yes	yes	no	yes
36	4;1	m	yes	yes	no	yes
37	4.416	f	yes	yes	no	yes
38	4.0	f	yes	yes	no	yes

Table 12: Results Child Participants Experiment IV

Chapter 4: Experiment V

The experiment contained seven true control items (QT) and six false control items (QF).

Version 1: The DR(IE)-trials preceded the IED(ER)-trials.

Version 2: The IED(ER)-trials preceded the DR(IE)-trials.

nr	age	gen	vers	qt(n)	qf(n)	droa1	droa2	droa3	drao1	drao2	drao3	iedoa	iedao
1	5;10	f	1	7	6	yes	yes	yes	no	no	no	yes	no
2	6;3	f	1	7	6	yes	yes	yes	no	no	no	no	no
3	6;2	f	1	7	6	yes	yes	yes	no	no	no	yes	no
4	6;4	m	1	6	5	yes	yes	yes	no	no	no	yes	no
5	6;2	m	1	7	6	yes	yes	yes	no	yes	no	yes	no
6	5;10	m	2	7	6	yes	yes	yes	no	no	no	yes	no
7	5;4	f	2	6	5	yes	yes	yes	no	yes	no	no	yes
8	5	f	2	7	6	yes	yes	yes	no	no	no	no	yes

Table 13: Results Child Participants Experiment V.

Chapter 4: Experiment VI

The experiment contained seven true control items (QT) and six false control items (QF).

Version 1: Birthday> shop> letters and packages> zoo.

Version 2: Shop> letters and packages> zoo> birthday.

Version 3: Letters and packages> zoo> birthday> shop.

Version 4: Zoo> birthday> shop> letters and packages.

nr	age	gen	vers	qt(n)	qf(n)	alao1	alao2	alao3	alao1	alao2	alao3	iedao	iedao
24	5;11	f	2	7	6	yes	yes	no	yes	no	no	no	yes
25	5;9	f	2	6	6	yes	yes	yes	no	yes	no	yes	no
26	4;8	m	3	5	6	yes	yes	yes	yes	yes	yes	yes	yes
27	4;7	m	3	5	6	yes	yes	yes	yes	no	yes	yes	yes
28	4;1	m	4	7	6	yes	yes	yes	yes	yes	yes	yes	yes
29	4.416	f	4	7	6	yes	yes	yes	no	no	yes	yes	no
30	4.0	f	4	5	6	yes	yes	no	yes	yes	no	yes	yes

Table 14: Results Child Participants Experiment VI.

Chapter 5: Experiment VII

Condition:

1= IEDER+ INDEF

- *Iedere jongen tilt een doos op.*
Every boy lifts a box up.
- *Iedere jongen draagt een doos.*
Every boy carries a box.
- *Ieder meisje houdt een plant vast.*
Every girl holds a plant tight.

2= ELK+INDEF

- *Elk meisje houdt een plant vast.*
Every girl holds a plant tight.
- *Elke jongen bouwt een toren.*
Every boy builds a tower.

3= ELK+Bare PL3

- *Elke jongen speelt met blokken.*
Every boy plays with building blocks.

4= ELK+ Bare PL4

- *Elke jongen speelt met blokken.*
Every boy plays with building blocks.

5= ELK + PROPER NAME

- *Ieder meisje schildert Sneeuwvitje.*
Every girl paints Snow White

6= ALLE+ INDEF

- *Alle jongens tillen een doos op.*
All boys lift a box up.
- *Alle meisjes houden een plant vast.*
All girls hold a plant fast.

Choices:

A: Partially-distributive event structure

B: Non-distributive event structure

Follow up question 1: Is the other picture also a possible depiction of the sentence?

Follow up question 2: How about a situation in which there is full distributivity?

nr	age	gen	condition	first choice	other picture possible?	full distributivity?
1	24	f	1	B	no	yes
2	18	f	2	B	yes	yes
3	19	m	1	B	yes	yes
4	48	f	3	A	no	yes
5	51	m	1	A	yes	yes
6	52	f	2	A	yes	yes
7	24	m	3	A	yes	yes
8	27	f	2	A	yes	yes
9	29	f	2	A	yes	yes
10	27	f	3	B	yes	yes
11	25	f	3	B	yes	yes
12	22	f	3	B	yes	yes
13	19	f	3	A	yes	yes
14	27	f	1	A	yes	yes
15	20	f	6	A	yes	yes
16	25	f	1	A	yes	yes
17	26	f	1	B	yes	yes
18	26	f	1	A	no	yes
19	23	f	1	A	yes	yes
20	23	f	1	A	yes	yes
21	38	f	6	A	yes	yes
22	26	f	3	A	yes	yes
23	19	m	2	A	yes	yes
24	19	f	1	B	yes	yes
25	27	m	1	A	no	yes
26	22	m	1	B	no	yes
27	27	f	1	A	yes	yes
28	23	f	2	B	yes	yes
29	22	f	6	A	yes	yes
30	26	f	6	B	no	yes
31	18	f	2	B	yes	yes
32	20	f	1	A	yes	yes
33	44	f	1	B	yes	yes
34	20	f	3	A	yes	yes
35	19	f	2	B	no	yes
36	19	f	1	B	yes	yes
37	22	m	2	A	no	yes
38	20	f	1	A	no	yes
39	21	f	2	A	no	yes
40	18	f	3	A	yes	yes
41	19	f	1	A	yes	yes

nr	age	gen	condition	first choice	other picture possible?	full distributivity?
42	22	m	2	A	yes	yes
43	22	m	3	A	no	yes
44	22	f	1	A	yes	yes
45	20	f	1	A	yes	yes
46	25	f	1	A	yes	yes
47	21	f	6	B	yes	yes
48	35	f	6	A	yes	yes
49	20	f	1	B	yes	yes
50	23	f	1	A	yes	yes
51	24	f	6	A	no	yes
52	21	f	1	B	yes	yes
53	21	f	1	A	no	yes
54	24	f	1	A	yes	yes
55	21	f	6	B	yes	yes
56	19	f	6	A	yes	yes
57	23	f	1	A	yes	yes
58	23	m	6	B	yes	yes
59	23	f	6	B	yes	yes
60	23	f	1	B	no	yes
61	29	f	1	A	no	yes
62	18	f	5	B	yes	yes
63	18	f	5	B	yes	yes
64	18	m	6	B	yes	yes
65	20	f	2	A	yes	yes
66	22	m	2	B	yes	yes
67	24	m	2	A	yes	yes
68	20	f	6	B	yes	yes
69	22	f	6	B	yes	yes
70	21	f	5	B	no	yes
71	21	m	6	B	no	yes
72	19	f	6	B	yes	yes
73	19	f	5	B	yes	yes
74	21	f	6	B	yes	yes
75	22	f	2	A	yes	yes
76	23	f	5	A	yes	yes
77	20	m	2	A	yes	yes
78	23	f	5	A	yes	yes
79	21	f	5	B	no	no
80	23	f	2	A	yes	yes
81	18	m	2	A	no	yes
82	21	f	2	A	yes	yes

nr	age	gen	condition	first choice	other picture possible?	full distributivity?
83	18	f	4	A	yes	yes
84	22	f	2	A	yes	yes
85	22	f	2	A	yes	yes
86	24	m	4	B	no	yes
87	18	f	4	A	yes	yes
88	20	m	4	A	yes	yes
89	19	m	4	B	yes	yes
90	22	f	4	A	yes	yes
91	20	f	4	A	yes	yes
92	20	m	4	B	yes	yes
93	19	f	4	A	yes	yes

Table 15: Results Adult Participants Experiment VII

Chapter 5: Experiment VIII

-Each child saw two QT and QF control items.

-Book 1 contained the ES1 and the NPDE conditions. There were three different dative stories: 'Birthday', 'Zoo' and 'Letters and Packages'. There were three distinct orderings:

Version 1: Zoo> letters and packages> birthday

Version 2: Letters and packages> birthday> zoo

Version 3: Birthday> zoo> letters and packages.

-Book 2 contained the ES2 and the NPDE conditions. Again there were three different dative stories and three different orderings:

Version 1: Zoo> letters and packages> birthday

Version 2: Letters and packages> birthday> zoo

Version 3: Birthday> zoo> letters and packages.

nr	age	gen	version	qt(n)	qf(n)	tpd	tc	doa	dao	npde1	npde2	es1-1	es1-2
1	5;2	m	1	2	2	yes	no	no	--	no	no	no	--
2	4;9	f	1	2	2	no	no	yes	no	yes	no	yes	yes
3	6	f	1	2	2	yes	yes	no	yes	no	no	no	no
4	6;6	m	1	2	2	yes	yes	no	yes	no	no	no	no
5	6;7	m	1	2	2	yes	yes	yes	yes	no	no	no	no
6	6;8	m	1	2	2	yes	yes	no	yes	no	no	no	no
7	6;6	m	1	1	2	yes	yes	no	yes	no	no	no	no
8	6;1	m	1	2	2	yes	yes	no	yes	no	no	no	no
9	5	f	2	0	2	yes	yes	no	yes	no	no	yes	no
10	5;5	m	2	1	0	yes	no	yes	no	yes	yes	yes	yes
11	5;2	m	2	2	1	yes	yes	yes	yes	no	yes	no	yes

nr	age	gen	version	qt(n)	qf(n)	tpd	tc	doa	dao	npde1	npde2	es1-1	es1-2
12	6;9	m	2	2	2	yes	yes	no	yes	no	no	no	no
13	4;3	f	2	1	1	yes	yes	yes	--	--	--	--	yes
14	4;7	m	3	2	1	yes	yes	yes	yes	yes	no	no	yes
15	4;10	f	3	2	2	yes	yes	no	yes	no	no	no	no
16	4;10	m	3	2	2	yes	yes	yes	yes	no	no	yes	yes
17	5;1	m	3	0	2	yes	yes	yes	no	no	no	yes	yes
18	5;9	f	3	2	2	yes	yes	no	no	no	no	no	no
19	6;2	m	2	2	2	no	no	no	yes	no	no	no	no
20	6;7	m	2	2	2	yes	yes	yes	yes	yes	yes	yes	no
21	5;8	m	1	2	2	yes	yes	no	yes	no	no	no	no
22	4;8	m	3	2	2	yes	yes	yes	yes	yes	yes	yes	yes
23	4;11	f	3	2	2	yes	yes	no	yes	no	no	no	yes
24	4;10	m	3	2	2	yes	yes	yes	yes	no	no	yes	yes

Table 16: Child Participants Experiment VIII, Book 1.

nr	age	gen	vers	qt(n)	qf(n)	tpd	tc	doa	dao	npdf1	npdf2	es2-1	es2-2
1	4:9	m	1	1	2	no	no	yes	no	yes	no	yes	yes
2	5:4	f	1	2	2	no	no	no	yes	yes	yes	no	no
3	5:4	m	1	1	2	yes	no	no	yes	yes	yes	no	no
4	5:6	f	1	0	2	yes	yes	no	yes	yes	yes	no	no
5	6:4	m	3	2	2	yes	no	no	yes	yes	yes	no	no
6	6:7	f	3	2	2	yes	yes	no	yes	no	yes	no	no
7	5:4	m	3	2	2	yes	yes	no	yes	yes	yes	no	no
8	5:2	f	2	1	2	yes	yes	no	yes	yes	yes	no	no
9	4:3	f	2	1	2	yes	yes	yes	yes	yes	no	yes	yes
10	5:5	f	2	2	2	yes	yes	no	yes	yes	yes	no	no
11	6:11	m	2	2	2	yes	yes	yes	no	no	no	yes	yes
12	5:9	f	1	2	1	yes	no	yes	no	yes	yes	no	no
13	4:6	f	1	1	2	yes	yes	no	yes	yes	yes	no	no
14	5:5	m	2	2	2	no	no	no	yes	yes	yes	no	no
15	6:1	f	2	2	2	yes	yes	no	yes	yes	yes	no	no
16	5:2	m	3	2	2	no	yes	no	yes	yes	yes	no	no
17	5:9	m	3	2	2	no	no	no	no	yes	yes	no	no

Table 17: Child Participants Experiment VIII, Book 2.

nr	age	gen	vers	qt(n)	qf(n)	tpd	tc	doa	dao	npde1	npde2	es1-1	es1-2
1	32	m	2	2	2	no	no	yes	no	no	no	yes	yes
2	32	f	3	2	2	no	yes	yes	no	no	no	yes	yes
3	28	m	1	2	2	yes	yes	yes	no	no	no	yes	yes
4	26	f	1	2	2	no	no	no	yes	no	no	no	yes
5	30	f	2	2	2	no	no	yes	no	no	no	yes	yes
6	24	f	2	2	2	yes	yes	yes	yes	yes	yes	yes	yes
7	31	m	3	2	2	no	no	yes	no	no	no	yes	yes
8	30	m	3	2	2	yes	yes	yes	yes	yes	yes	yes	yes
9	30	f	2	2	2	no	no	yes	no	no	no	yes	yes
10	31	f	3	2	2	no	no	yes	no	no	no	yes	yes
11	28	f	1	2	2	yes	yes	no	yes	no	no	no	no
12	31	m	1	2	2	yes	yes	yes	no	yes	yes	yes	yes
13	27	f	3	2	2	yes	yes	no	yes	yes	yes	yes	yes
14	29	f	2	2	2	no	yes	yes	no	no	no	yes	yes

Table 18: Adult Participants Experiment VIII, Book I.

nr	age	gen	vers	qt(n)	qf(n)	tpd	tc	doa	dao	npdf1	npdf2	es2-1	es2-2
1	55	m	1	2	2	yes	yes	yes	no	no	no	yes	yes
2	27	f	1	2	2	no	no	yes	no	no	no	yes	yes
3	30	f	2	2	2	yes	yes	yes	no	no	no	yes	yes
4	51	f	2	2	2	no	no	no	yes	yes	yes	no	no
5	25	m	3	2	2	no	yes	yes	no	no	no	yes	yes
6	26	f	3	2	2	no	no	yes	no	no	no	yes	yes
7	25	f	3	2	2	yes	yes	yes	no	no	no	yes	yes
8	61	f	3	2	2	yes	no	yes	yes	no	no	yes	yes
9	25	m	2	2	2	no	yes	no	yes	yes	yes	yes	yes
10	55	m	2	2	2	yes	no	yes	no	no	no	yes	yes
11	25	m	1	2	2	no	no	yes	no	no	no	yes	yes
12	27	f	1	2	2	yes	yes	yes	yes	no	no	yes	yes
13	26	f	1	2	2	yes	no	yes	yes	yes	yes	no	yes
14	27	f	1	2	2	no	no	yes	yes	yes	yes	no	yes
15	55	f	3	2	2	yes	no	yes	no	no	no	yes	yes
16	27	f	3	2	2	no	no	yes	no	no	no	yes	yes
17	30	f	2	2	2	no	no	no	yes	yes	yes	yes	yes

Table 19: Adult Participants Experiment VIII, Book 2.

Samenvatting in het Nederlands

Wanneer er twee of meer kwantoren in dezelfde zin voorkomen, zijn er vaak meerdere bereiksrelaties mogelijk tussen deze kwantoren en daarom zijn deze zinnen vaak dubbelzinnig. Een Engelse zin zoals *Someone loves everyone* kan bijvoorbeeld betekenen dat er een bepaalde persoon is die van iedereen houdt, of dat er voor iedereen een (mogelijk verschillende) persoon is die van hem of haar houdt. In het eerste geval zeggen we dat *someone* groot-bereik heeft (en *everyone* klein-bereik). Voor de tweede interpretatie moet *everyone* groot-bereik hebben (en *someone* klein-bereik). Echter, in sommige zinnen gaat de bovenstaande generalisatie niet op en lijkt het bereik van één of meerdere kwantoren op enige wijze beperkt te zijn. Dit gebeurt onder andere in de dubbel-objectzin in (1).

(1) De man heeft een meisje elke appel verkocht.

De bovenstaande zin kan alleen betekenen dat er een bepaald meisje is aan wie de man alle appels heeft verkocht (groot-bereik van *een meisje*), maar niet dat voor elke appel er een (mogelijk verschillend) meisje is aan wie de man het verkocht. Logisch gezien zouden allebei de interpretaties mogelijk moeten zijn, er is echter maar één mogelijke interpretatie. Deze beperking op de interpretatie van kwantoren in bepaalde dafiefconstructies noemen we SCOPE FREEZING (Larson, 1990; Bruening, 2001).

De vraag die ons in dit proefschrift bezig houdt, is hoe en wanneer kinderen leren dat er voor bovenstaande zin maar één interpretatie mogelijk is. Su en Crain (2000) en Su (2001a,b) ontdekten dat Engelstalige kinderen die rond de vijf jaar oud waren, de restricties op kwantoren bereik nog niet verworven hadden en dat ze bovendien verrassende 'fouten' maken in de interpretatie van zulke zinnen. Wanneer kinderen een zogenoemde ONE>ALL situatie voorgeschoteld krijgen, een situatie waarin alle appels aan één meisje worden verkocht, vinden kinderen een zin als (1) geen juiste beschrijving van deze situatie. Wanneer kinderen een ALL>ONE situatie zien, een situatie waarin elke appel aan een verschillend meisje wordt verkocht, dan vinden kinderen zin (1) juist wel een juiste beschrijving van de situatie. Voor volwassenen is het omgekeerde het geval. Zij vinden zin (1) een goede beschrijving van een ONE>ALL situatie, maar niet van een ALL>ONE situatie. Het interpretatiepatroon dat kinderen laten zien is dus

het tegenovergestelde van het patroon dat volwassenen laten zien en we noemen dit patroon daarom het REVERSE-PATTERN.

In hoofdstuk 2 hebben we laten zien dat dit patroon zowel bij Engelstalige en Nederlandstalige kleuters (4-6 jaar oud) voorkomt. Verder zagen we dat dit patroon niet alleen voorbehouden is aan zinnen zoals (1), maar ook voorkomt met andere soorten datiefzinnen en bepaalde transitieve zinnen. We lieten ten slotte zien dat de afwijkende lezingen die kinderen aan zin (1) toewijzen niet te wijten zijn aan een onvolledige verwerving van de syntactische structuur van de constructie of een interpretatiestrategie die automatisch de universele kwantor groot-bereik toewijst en dat het Reverse-pattern niet hetzelfde fenomeen is als EXHAUSTIVE PAIRING (Inhelder en Piaget, 1967; Philip, 1995 e.v.a.).

Alle zinnen waar we het omgekeerde patroon aantreffen bevatten een onbepaald lidwoord. Su (2001b) hypotheetiseerde dat kleuters de betekenis van dit lidwoord nog niet compleet verworven hebben. In hoofdstuk 3 introduceerden we twee specifieke hypothesen om deze bewering te onderzoeken. De eerste is de Aangepaste Lexicale Factor Hypothese (gebaseerd op Su's Lexicale Factor Hypothese), die zegt dat kinderen niet-overlappende betekenissen toewijzen aan het onbepaalde lidwoord *een* (of *a/an*) en het nummerwoord *één* (of *one*). Voor kinderen verwijst het nummerwoord naar verzamelingen en groepen met een kardinaliteit van één (11). Omdat het nummerwoord al naar deze betekenis verwijst, kan voor kinderen het lidwoord *een* deze betekenis niet hebben. Om zin (1) een juiste beschrijving van een ONE>ALL situatie te laten zijn moet het onbepaalde lidwoord verwijzen naar een enkel meisje. Als kinderen deze betekenis niet toestaan, dan verklaart dit waarom ze testzinnen onwaar vinden in ONE>ALL situaties. In ALL>ONE situaties moet het onbepaalde lidwoord verwijzen naar meer dan één meisje. Deze betekenis is mogelijk en daarom vinden kinderen testzinnen waar voor ALL>ONE situaties. Impliciet in deze discussie is dat kinderen geen kennis hebben van het abstracte principe van Scope Freezing. Een voorspelling van de Aangepaste Lexicale Factor Hypothese is dat het Reverse-pattern alleen voor zou moeten komen met zinnen die het specifieke onbepaalde lidwoord *een* (of *a/an*) bevatten en niet met zinnen die andere onbepaalde uitdrukkingen, zoals *some* (enkelvoud), bevatten. Verder zouden kinderen het nummerwoord *één* (en Engels *one*) altijd moeten laten verwijzen naar singletons, ofwel groepen die maar één element bevatten.

De tweede hypothese die we introduceerden is de Singleton Restrictie Hypothese. Deze hypothese zegt dat het Reverse-pattern niet voortkomt uit een probleem met de interpretatie van een een specifiek

onbepaald lidwoord, maar uit een probleem met de interpretatie van onbepaalde uitdrukkingen in het algemeen. Volgens deze hypothese lukt het kinderen in bepaalde situaties niet het domein van een onbepaalde uitdrukking zo te definiëren dat het maar één element bevat. Situaties waarin dit kinderen niet lukt, zijn situaties waarin er meerdere mogelijke referenten voor een onbepaalde uitdrukking zijn. De Singleton Restrictie Hypothese voorspelt dat het Reverse-pattern altijd voorkomt wanneer onbepaalde lidwoorden gebruikt worden in een situatie waarin er meerdere mogelijke referenten zijn voor het lidwoord. In alle ONE>ALL situaties waren er meerdere meisjes aan wie de man de appels kon verkopen. Om de zin in (1) een juiste beschrijving van de situatie te vinden, moesten kinderen één van de meisjes als referent nemen. In ALL>ONE situaties was dit niet nodig en daarom hebben kinderen geen problemen met de interpretatie van testzinnen in dit situatie-type.

Aan de hand van drie experimenten (gebruikmakend van de zogenoemde Truth-Value Judgment-task) lieten we zien dat (i) het Reverse-pattern niet alleen bij het onbepaalde lidwoord *een* (of *a/an*) voorkomt, maar ook bij andere indefiniten, zoals *some* (enkelvoud), (ii) het Reverse-pattern ook voorkomt als Engelse kinderen met het nummerwoord *one* geconfronteerd worden, en (iii) dat wanneer we zinnen zonder universele kwantor maar met onbepaald lidwoord presenteren in een situatie waarin er meerdere mogelijke referenten voor het onbepaalde lidwoord zijn (en kinderen dus moeite zouden moeten hebben met het beperken van het domein van de onbepaalde uitdrukking in kwestie), kinderen geen problemen hebben met de interpretatie van onbepaalde lidwoorden.

De resultaten van de experimenten leverden bewijs tegen zowel de Aangepaste Lexicale Factor Hypothese als de Singleton Restrictie Hypothese en suggereerden dat het niet zozeer de aanwezigheid van een onbepaalde uitdrukking, maar de aanwezigheid van een universele kwantor is die ertoe leidt dat kinderen de testzinnen anders interpreteren dan volwassenen.

In hoofdstuk vier onderzochten we of het Reverse-pattern inderdaad wordt veroorzaakt door de aanwezigheid van een universele kwantor en indien dit zo is, of het Reverse-pattern voorkomt met alle universele kwantoren. Ten einde de eerste vraag te beantwoorden presenterden we kinderen met datiefconstructies met het nummerwoord *drie* (zoals in (2)) in ONE>ALL en ALL>ONE situaties (zie boven voor een beschrijving van de situatie-typen). Het nummerwoord *drie* werd gekozen omdat deze uitdrukking op veel vlakken overeenkomsten heeft met universele kwantoren.

- (2) De beer heeft een vos drie stukken taart gegeven.

De resultaten van het experiment lieten zien dat kinderen zinnen met *drie* net zo interpreteerden als volwassenen dat doen. Dit suggereert dat het Reverse-pattern inderdaad voorbehouden is aan zinnen die universele kwantoren bevatten. De tweede vraag werd ingegeven door de Distributiviteitshypothese (gebaseerd op Drozd en Van Loosbroek, 2006). Volgens deze hypothese beoordelen kinderen testzinnen als onwaar wanneer er een ‘mismatch’ is tussen de distributiviteitskarakteristieken van de universele kwantor en de manier waarop kinderen een situatie interpreteren. Als een context niet ondubbelzinnig distributiviteit ondersteunt, dan vinden kinderen testzinnen onwaar. Voor kinderen passen dan de testzin en de context niet bij elkaar en ze zijn niet in staat verschillen te accommoderen.

Een voorspelling van de Distributiviteitshypothese is dat kinderen alleen problemen zouden moeten hebben met zinnen die een distributieve universele kwantor bevatten (*elke, ieder*) en niet met zinnen die een collectieve universele kwantor zoals *alle* bevatten (zie (3) voor voorbeelden).

- (3) a. De beer heeft een vos alle stukken taart gegeven.
b. De beer heeft een vos ieder stuk taart gegeven.

De resultaten van een Truth-Value Judgment-experiment waarin kinderen zowel zinnen als (3a) en zinnen als (3b) zagen, lieten een significant verschil tussen de twee kwantoren zien. Kinderen lieten het Reverse-pattern zien met *elk* en *ieder*, maar niet met *alle*. De conclusie die we hieruit trokken was dat alleen een subgroep van de universele kwantoren kinderen induceert het Reverse-pattern te laten zien. Een kenmerk van deze groep kwantoren is dat ze allemaal distributiviteitkarakteristieken als onderdeel van hun lexicale opmaak hebben. De vraag die we ons vervolgens stelden was wat de rol van distributiviteit is en hoe kinderen distributieve kwantoren precies interpreteren.

In hoofdstuk 5 introduceerden we ‘gebeurtenissen’ en de structuur van gebeurtenissen en we trachtten te bepalen wat voor soort gebeurtenisstructuren kinderen en volwassenen als distributief zouden bestempelen. We introduceerden ook Tunstall’s Gebeurtenisdistributiviteitshypothese (Tunstall, 1998) die zegt dat een kwantor zoals *elk* en *ieder* (en Engels *every*) alleen verenigbaar is met een gebeurtenisstructuur die tenminste deels distributief is, wat betekent dat tenminste twee verschillende (niet-

overlappende) subgroepen uit het domein van de gekwantificeerde frase aan verschillende subgebeurtenissen moeten kunnen worden gekoppeld. Echter, volwassenen kunnen hier onder bepaalde voorwaarden van afwijken, al kost dit meer moeite en moet er een reden voor zijn.

Een voorspelling van de Gebeurtenisdistributiviteitshypothese is dat volwassenen, wanneer ze een zin zien met een kwantoor zoals *elk* of *ieder*, een gebeurtenisstructuur met twee subgebeurtenissen altijd moeten prefereren over een structuur met maar één subgebeurtenis. Een experiment (Picture-Selection-task) liet zien dat dit niet het geval is en dat volwassenen eigenlijk altijd een gebeurtenisstructuur prefereren waarin elk object uit het domein van de universele kwantoor gekoppeld wordt aan een aparte, niet-overlappende deelgebeurtenis. Zo'n gebeurtenisstructuur noemen we een prototypisch distributieve structuur. Aan de hand van de bovenstaande resultaten ontwikkelden we twee versies van de Prototypische Distributiviteits Hypothese:

(7) De Zwakke Prototypische Distributiviteits-hypothese

Distributieve universele kwantoren dwingen een prototypisch distributieve gebeurtenisstructuur af, met andere woorden een gebeurtenisstructuur waarin elk element in het domein van de universele kwantoor gekoppeld is aan een aparte deelgebeurtenis. Volwassenen kunnen onder bepaalde omstandigheden afwijken van deze prototypische interpretatie, maar kinderen kunnen dit nog niet.

(8) De Sterke Prototypische Distributiviteits-hypothese

Distributieve universele kwantoren dwingen een prototypisch distributieve gebeurtenisstructuur af, met andere woorden een gebeurtenisstructuur waarin elk element in het domein van de universele kwantoor gekoppeld is aan een aparte deelgebeurtenis. Bovendien moeten deze deelgebeurtenissen onafhankelijk zijn. Volwassenen kunnen onder bepaalde omstandigheden afwijken van deze prototypische interpretatie, maar kinderen kunnen dit nog niet.

Allebei de hypothesen voorspellen dat kinderen problemen moeten hebben met situaties waarin niet elk element of object in het domein van de universele kwantoor aan een aparte deelgebeurtenis gekoppeld is. Deze voorspelling werd getest in een nieuw experiment waarin kinderen situaties beoordeelden die op een subtiele manier afweken van de ideale prototypisch distributieve gebeurtenisstructuur. De twee hypothesen verschillen wat betreft hun voorspelling voor situaties waarin de subgebeurtenissen

overlappen. Volgens de sterke hypothese moeten alle deelgebeurtenissen onafhankelijk zijn en mogen ze dus niet overlappen. De zwakke hypothese staat overlap toe. Met andere woorden, wanneer we de zin *De beer verkocht een meisje elke appel* nemen, dan moet volgens de sterke hypothese elke appel aan een verschillend meisje worden verkocht, terwijl volgens de zwakke versie er meerdere appels aan hetzelfde meisje mogen worden verkocht, als er maar aparte verkoop-gebeurtenissen zijn.

De resultaten lieten zien dat prototypische distributiviteit op zichzelf het gedrag dat kinderen vertonen niet kan verklaren. Alle situaties waarin kinderen de testzinnen juist vonden hadden ook nog een ander kenmerk, namelijk Volledige Groeps koppeling ('Full Set Linking'). Dit betekent dat de groep van elementen in het domein van de kwantoor (e.g. in (3b) de groep vossen) en de groep van objecten die eraan gekoppeld worden (in (3b) de stukken taart) volledig aan elkaar gekoppeld moeten worden. Elk element uit groep 1 moet gekoppeld zijn aan een of meerdere objecten uit de andere groep en vice versa. Dit principe lijkt voor kinderen belangrijker te zijn dan prototypische distributiviteit.

In hoofdstuk 6 stelden we een nieuwe theorie voor om het bovenstaande te verklaren. Allereerst betoogden we dat de zwakke vorm van prototypische distributiviteit behouden moet blijven. Ten tweede betoogden we dat wanneer volwassenen een universele kwantoor interpreteren ze allereerst kijken of de situatie waarin de kwantoor gebruikt wordt voldoet aan de conditie van prototypische distributiviteit. De gemakkelijkste manier om te kijken of dit het geval is, is door middel van een interpretatiestrategie waarbij volwassenen kijken of er tussen twee groepen elementen een één-op-één relatie is. Wanneer deze relatie niet gevonden wordt, dan wisselen volwassenen hun interpretatiestrategie en gaan ze kijken of elk element uit het domein van de universele kwantoor deelneemt aan een aparte deelgebeurtenis. Wanneer kinderen universele kwantoren interpreteren beginnen ze met dezelfde interpretatiestrategie als volwassenen, namelijk het zoeken naar een één-op-één relatie. Wanneer die strategie niet werkt lukt het kinderen niet om van strategie te veranderen. Kinderen blijven dus hangen in de eerste interpretatie-strategie. Kinderen zijn wel in staat sommige afwijkende situaties te accommoderen, namelijk situaties met het kenmerk van Volledige Groeps koppeling. In deze situaties hebben de groepen objecten geen één-op-één relatie, maar elk object maakt deel uit van een bepaalde relatie en er is geen enkel object dat buiten wordt gesloten. Ten slotte betoogden we dat kinderen geen kennis hebben van Scope Freezing, omdat dit beperkingsprincipe voortkomt uit kennis van de

informatiestructuur van de taal die kinderen leren en kinderen deze kennis pas laat verwerven.

Curriculum Vitae

Marie-Elise van der Ziel was born on January 16, 1984 in Apeldoorn. In 2003 she started her studies in English Language and Culture at Utrecht University. She completed her Bachelor's degree in 2006 (cum laude). She subsequently enrolled in the research master *Linguistics: The Study of the Language Faculty*, which she completed in 2008 (cum laude). From September 2008 till January 2012 Marie-Elise worked as a PhD-student at the Utrecht Institute of Linguistics (OTS), where she carried out research in the NWO-financed project: 'Assessing the relative contributions of competence and performance in child language'. This dissertation is the result of the research carried out in this project.