

# Complexity of familial amyotrophic lateral sclerosis

*FALS = C9orf72 + TARDBP + FUS/TLS + UCP +  
ATXN2 + CTARDBP + C9orf72) + (FUS/TLS +  
C9orf72) + CSOD1 + C9orf72) + (UQAPB + C9orf72) +  
CTARDBP + atg) + (FUS/TLS + atg) + (...) = Complex*

Marka van Blitterswijk

Omdat het belangrijk is op duurzame wijze met natuurlijke bronnen om te gaan is dit proefschrift gedrukt op een papiersoort welke voortkomt uit verantwoorde bosbouw. Er is gebruik gemaakt van plantaardige inkt en gedrukt zonder schadelijke oplosmiddelen. Dit proefschrift is gedrukt door Ecodrukkers.

**Cover design** Kitty van der Veer, Proefschrift.nu

**Layout** Renate Siebes, Proefschrift.nu

**ISBN** 978-90-393-5770-5

© 2012 **Marka van Blitterswijk**

All rights reserved. No part of this publication may be reproduced, stored in a retrieval system, or transmitted, in any form or by any means, electronic, photocopying, or otherwise, without the permission of the author, or, when appropriate, of the publishers of the publications.

# **Complexity of familial amyotrophic lateral sclerosis**

Complexiteit van familiale amyotrofische laterale sclerose  
(met een samenvatting in het Nederlands)

## **Proefschrift**

ter verkrijging van de graad van doctor aan de  
Universiteit Utrecht op gezag van de rector magnificus,  
prof.dr. G.J. van der Zwaan, ingevolge het besluit van het  
college voor promoties in het openbaar te verdedigen  
op dinsdag 29 mei 2012 des middags te 2.30 uur

door

**Marka Maria van Blitterswijk**

geboren op 5 april 1984  
te Delft

**Promotor:** Prof.dr. L.H. van den Berg

**Co-promotoren:** Dr. J.H. Veldink  
Dr. M.A. van Es

This thesis was generously supported by Stichting Mitalto, the J.E. Jurriaanse Stichting, Janssen-Cilag B.V., Biogen Idec International BV, Van Lanschot Bankiers, and the Alkemade - Keuls Fonds.

# Contents

|  |  |     |
|--|--|-----|
| Chapter 1  | Introduction and outline   | 9   |
| <b>PART I Genetic studies; amyotrophic lateral sclerosis</b> |  |     |
| Chapter 2  | Paraoxonase gene mutations in amyotrophic lateral sclerosis                                    | 27  |
| Chapter 3  | Rare and common paraoxonase gene variants in amyotrophic lateral sclerosis patients            | 45  |
| Chapter 4  | Novel optineurin mutations in sporadic amyotrophic lateral sclerosis patients                  | 63  |
| Chapter 5  | <i>VCP</i> mutations in familial and sporadic amyotrophic lateral sclerosis                    | 81  |
| Chapter 6  | <i>UBQLN2</i> in familial amyotrophic lateral sclerosis in The Netherlands                     | 95  |
| Chapter 7  | Expanded <i>ATXN2</i> CAG repeat size in ALS identifies genetic overlap between ALS and SCA2   | 103 |
| Chapter 8  | Hexanucleotide repeat expansions in <i>C9orf72</i> in the spectrum of motor neuron diseases    | 117 |
| Chapter 9  | Evidence for a polygenic basis of amyotrophic lateral sclerosis                                | 135 |
| Chapter 10   | <i>VAPB</i> and <i>C9orf72</i> mutations in one familial amyotrophic lateral sclerosis patient | 163 |

## PART II Genetic studies; other neurodegenerative diseases

|            |  |     |
|------------|--|-----|
| Chapter 11 | Genetic overlap between apparently sporadic motor neuron diseases                                | 177 |
| Chapter 12 | Mutations in the <i>TRPV4</i> gene are not associated with sporadic progressive muscular atrophy | 193 |
| Chapter 13 | Mutational analysis of <i>TARDBP</i> in neurodegenerative diseases                               | 199 |
| Chapter 14 | Mutational analysis of <i>TARDBP</i> in Parkinson's disease                                      | 211 |
| Chapter 15 | Paraoxonase gene mutations are not associated with Parkinson's disease                           | 217 |

## PART III Functional studies

|            |   |     |
|------------|---|-----|
| Chapter 16 | RNA processing pathways in amyotrophic lateral sclerosis  | 229 |
| Chapter 17 | Characterization of <i>FUS/TLN1</i> mutations in amyotrophic lateral sclerosis using RNA-Seq                              | 263 |
| Chapter 18 | TDP-43 plasma levels: a biomarker for amyotrophic lateral sclerosis?  | 293 |
| Chapter 19 | Anti-superoxide dismutase antibodies are associated with survival in patients with sporadic amyotrophic lateral sclerosis | 305 |
| Chapter 20 | General discussion and summary  | 329 |
|            | Samenvatting (Summary in Dutch)   | 357 |
|            | Dankwoord (Acknowledgements)  | 367 |
|            | About the author  | 371 |
|            | Appendix  | 377 |



# 1

**“The soul cannot produce any movement in the body without the appropriate disposition of the bodily organs which are required for making the movement... no matter how much we may will this to happen.”**

The Philosophical Writings of Descartes.



## Introduction and outline

*“My name is N., I am 25 years of age. Seven years ago, my father told me that he was diagnosed with amyotrophic lateral sclerosis (ALS), and that he would probably die within five years. While I had never heard of ALS, I searched the internet, and came across many devastating stories. I felt very angry, and started screaming and kicking. I could not believe this was happening to my father.”*

## ALS

Each year approximately 400 patients are diagnosed with ALS in The Netherlands.<sup>1</sup> These patients are ~65 years of age at time of diagnosis.<sup>1</sup> They develop progressive muscle weakness, frequently affecting their arms, legs and trunk, but also muscles involved in speech, swallowing and breathing. ALS patients usually die within three years due to respiratory failure.<sup>1</sup> There is no cure for ALS and only Riluzole prolongs survival with two to three months.<sup>2</sup>

*“Against all odds, my father is still alive: his disease progression was relatively slow. It started in his arms, and subsequently affected his legs. Although he became wheelchair bound, his speech is still intact. It is very difficult to see my father like this; he has always been very strong, both mentally and physically.”*

The pathogenesis of ALS is complex and involves both genetic and environmental factors. In ~5% of the cases more than one family member is affected.<sup>3</sup> These patients are diagnosed with familial ALS (FALS).

*“Almost two years ago, my aunt developed weakness of her hand. She prayed that her complaints were not caused by ALS. Within half a year, however, she was also diagnosed with ALS, and we realized there was a genetic component in our family. This was confirmed by the identification of a genetic abnormality (mutation) in TAR DNA-binding protein (TARDBP).”*

In 1993, the first candidate gene for FALS was reported: superoxide dismutase-1 (*SOD1*).<sup>4</sup> Linkage analysis had pointed towards *SOD1*, and direct sequencing of thirteen FALS families had revealed heterozygosity in the DNA sequence, indicating one normal and one abnormal chromosome. In all these families single base pair changes were identified, which caused eleven distinct amino-acid substitutions (missense mutations). These *SOD1* changes were not detected in more than 100 chromosomes from normal individuals. *SOD1* is known to catalyze the dismutation of the toxic superoxide anion  $O_2^-$  to  $O_2$  and  $H_2O_2$ , and it was thus believed that 'the simplest hypothesis is that the mutations in the *SOD1* gene cause FALS' due to the formation of free radicals that result in neuronal injury.<sup>4</sup> Since the discovery of *SOD1*, many other genes have been shown to be causative for ALS. In the first part of this thesis, we will discuss eleven ALS-associated genes.

## Genetic studies; ALS

### Paraoxonase (*PON*)

In **Chapter 2 and 3** we will focus *PON*. *PON1* was identified due to its ability to hydrolyze organophosphates and pesticides, including paraoxon.<sup>5,6</sup> Many associations between *PON1* polymorphisms and diseases have been suggested, these include neurological diseases, like multiple sclerosis (MS), Alzheimer's disease (AD) and Parkinson's disease (PD).<sup>7-12</sup> Since reports that military personnel, who were deployed during the Gulf War, had a two-fold increased risk of developing ALS,<sup>13-16</sup> the role of *PON* polymorphisms have been studied in ALS patients as well. Studies have described associations between *PON* polymorphisms and ALS;<sup>17-22</sup> nonetheless, genome-wide association studies (GWAS) and a recent meta-analysis could not confirm this association.<sup>23</sup> To elucidate the role of *PON* in the pathogenesis of ALS, we assessed the frequency of *PON* mutations in two large cohorts of ALS patients and control subjects. In addition, we assessed the frequency of *PON* polymorphisms.

### Optineurin (*OPTN*)

In 2010, six Japanese individuals from consanguineous marriages who had ALS were analyzed.<sup>24</sup> These consanguineous marriages indicated a homozygous mutation (with two abnormal chromosomes), and this enabled usage of homozygosity mapping, which allows detection of a run of homozygous polymorphisms (RHSs). A region on chromosome ten overlapped among four subjects, and was chosen as the primary candidate region. This region contained seventeen candidate genes, and sequencing of

these genes resulted in the identification of *OPTN* mutations.<sup>24</sup> *OPTN* normally regulates membrane trafficking, Golgi ribbon formation, exocytosis, and cellular morphogenesis due to interactions with huntingtin (Htt), Rab8 and Myosin VI.<sup>25-27</sup> Furthermore, *OPTN* interacts with group 1 metabotropic glutamate receptors (mGluRs) that play an important role in regulating neuronal function.<sup>28</sup> It also affects transcription activation through interactions with transcription factor IIIA-interacting protein (TFIIIA), and is involved in autophagy.<sup>29-31</sup> To investigate the frequency of mutations and polymorphisms in *OPTN*, we decided to screen a large cohort of FALS patients, sporadic ALS (SALS) patients and control subjects of Dutch descent (**Chapter 4**).

### Valosin-containing protein (*VCP*)

New technological developments accelerated the search for candidate genes. Whole-exome sequencing, for instance, is able to cover all protein coding regions of the genome with massive parallel sequencing. This technique was used to investigate two ALS patients from a four-generation Italian family, and resulted in the identification of 75 heterozygous coding variants and thirteen heterozygous coding insertions/deletions (indels).<sup>32</sup> These variants were tested in another affected family member, thereby reducing this list to 24 variants and nine indels. Four of these variants were consistent with linkage analysis, not present in control subjects, and predicted to have damaging effects.<sup>32</sup> One of them was a mutation in *VCP*, and sequencing of 210 FALS patients confirmed its involvement in ALS.<sup>32</sup> *VCP* mutations were originally reported to cause inclusion body myopathy with Paget's disease of the bone and frontotemporal dementia (IBMPFD),<sup>33</sup> a degenerative disorder mainly affecting muscle, brain and bone tissue. *VCP* is implicated in mitosis, cell death, organelle biogenesis, membrane fusion, and protein degradation pathways, and, in addition, it functions in protein inclusion formation.<sup>34</sup> In **Chapter 5**, we will report the frequency of *VCP* mutations in Dutch ALS patients.

### Ubiquilin-2 (*UBQLN2*)

Mutations in *UBQLN2*, which encodes the ubiquitin-like protein ubiquilin-2, were identified in a five-generation family with ALS.<sup>35</sup> In this family, ALS was transmitted in a dominant fashion with reduced penetrance in females and no evidence for male-to-male transmission. Hence, this family was screened with markers from the X-chromosome. A region with 191 protein-coding genes was identified, and these genes were filtered based on their expression profile, function, structure and potential relevance of their encoded proteins. Sequencing of 41 selected genes eventually revealed a mutation in

*UBQLN2*. *UBQLN2* is a member of the ubiquilin family, which is thought to regulate the degradation of ubiquitinated proteins.<sup>36</sup> We will report the mutation frequency of *UBQLN2* in The Netherlands (**Chapter 6**).

### Ataxin-2 (*ATXN2*)

Previous studies identified TDP-43 as the major component of ubiquitin-positive inclusions (UBIs) in brain tissues from ALS patients.<sup>37</sup> To gain insight into the mechanism of TDP-43 pathogenesis, 5,500 yeast genes were transformed into a yeast strain expressing TDP-43.<sup>38</sup> Hereby, genes were identified that influenced TDP-43 toxicity. Pab1-binding protein 1 (PBP1), an orthologue of the *ATXN2* gene, was shown to enhance TDP-43 toxicity.<sup>38</sup> Triplet-repeat expansions in *ATXN2* were already known to cause spinocerebellar ataxia type 2 (SCA2), a neurodegenerative disease characterized by ataxia, dysarthria, and eye movement disorders.<sup>39</sup> Subsequently, the presence of *ATXN2* repeat expansions was investigated in 915 ALS patients and 980 control subjects, and this identified an association between intermediate-length *ATXN2* repeat expansions and ALS. In **Chapter 7**, we will describe the association between *ATXN2* repeat expansions and ALS in Belgium and in The Netherlands.

### Chromosome 9 open reading frame 72 (*C9orf72*)

Despite the identification of novel ALS-associated genes (**Chapter 2-7**), less than 5% of the FALS cases appeared to be caused by mutations in these genes. The discovery of *C9orf72* repeat expansions, however, introduced a major causative gene.<sup>40;41</sup> These repeat expansions were located in one of the five genes on chromosome 9p21 that were revealed by linkage analysis.<sup>42-49</sup> *C9orf72* repeat expansions probably result in accumulation of repeated nucleotides in RNA foci, which sequester RNA-binding proteins and disrupt mRNA splicing.<sup>41</sup> **Chapter 8** reports the presence of *C9orf72* repeat expansions in Dutch ALS patients.

### Five major ALS-associated genes

In many of our Dutch FALS pedigrees, we observed individuals that were obligate carriers of pathogenic mutations, but did not develop ALS (incomplete penetrance). We hypothesized that this phenomenon might be due to polygenic inheritance of ALS, and therefore, we decided to screen Dutch ALS patients for mutations in five major ALS-associated genes: *TARDBP*, fused in sarcoma / translated in liposarcoma (*FUS/TLS*), *SOD1*, angiogenin (*ANG*), and *C9orf72*. Our results will be discussed in **Chapter 9**.

*“The clinical geneticist gave us more information on ALS and its genetic causes, and asked us whether we wanted to know if we had the same genetic abnormality in TARDBP. I had already made up my mind, and several months later, the clinical geneticist said she had bad news: I had the same genetic abnormality as my father.”*

### Vesicle-associated membrane protein B (VAPB)

To extend our search, we also investigated our cohort of well-genotyped FALS patients for mutations in VAPB. VAPB is involved in many cellular processes, including lipid metabolism, membrane trafficking, the unfolded protein response (UPR), proteasome activity, microtubule organization, and endoplasmic reticulum (ER) homeostatic and stress signaling systems.<sup>50-53</sup> Currently, only two VAPB mutations have been identified in ALS patients<sup>54-55</sup>. In **Chapter 10**, we will describe the identification of a novel VAPB mutation.

## Genetic studies; other neurodegenerative diseases

The next part of this thesis will address other neurodegenerative diseases. **Chapter 11 and 12** will cover progressive muscular atrophy (PMA). This disease is characterized by progressive loss of lower motor neurons, and causes severe muscle weakness. PMA accounts for 5-10% of the adult-onset motor neuron diseases (MND).<sup>56-58</sup> Clinical and pathological similarities between PMA and ALS have already been reported,<sup>59-65</sup> we investigated a possible genetic overlap. Therefore, we sequenced ALS-associated genes *SOD1*, *ANG*, *FUS/TLS*, and *TARDBP* in PMA patients. Moreover, we investigated the mutation frequency of multivesicular body protein 2B (*CHMP2B*). *CHMP2B* mutations have been reported in patients with PMA,<sup>66,67</sup> and were originally identified in a large Danish pedigree with autosomal dominant frontotemporal dementia (FTD).<sup>68</sup>

In **Chapter 12**, we will investigate the mutation frequency of transient receptor potential cation channel, subfamily V, member 4 (*TRPV4*). Mutations in *TRPV4* have been described in congenital distal spinal muscular atrophy, scapuloperoneal spinal muscular atrophy (SPSMA) and hereditary motor and sensory neuropathy type IIC (HMSN IIC/CMT2C),<sup>69-71</sup> and have been shown to cause a predominant, or pure, lower motor neuropathy with axonal characteristics.<sup>72</sup>

**Chapter 13-15** will cover PD, a common neurodegenerative disorder characterized by an expressionless face, monotonous speech, shaking, stiffness, slowness of movements, and a shuffling gait. Previous studies have revealed several similarities between ALS and PD. TDP-43-positive inclusions, for instance, have also been identified in PD cases,<sup>73</sup> and mutations in *TARDBP* have been detected in PD patients as well.<sup>74</sup> We will report the mutation frequency of *TARDBP* and *PON* in Dutch PD patients.

*“I had just been told that I have an increased risk of developing ALS... In the evening I talked to my boyfriend, we discussed the possibility of having children. We would love to have children, but they would have a 50% chance of inheriting the same genetic abnormality, so what should we do? We would love to have children; however, we do not want our children to inherit this genetic variant.”*

## Functional studies

RNA processing is of crucial importance for the expression of genetic information. In **Chapter 16**, we will review the discovery, function, and commonalities of *ANG*, elongator protein 3 (*ELP3*), *FUS/TLS*, senataxin (*SETX*), survival motor neuron (*SMN*), and *TARDBP*. Hereby, we will emphasize the essential role of RNA processing in the development of ALS.

In **Chapter 17**, we will further investigate *FUS/TLS*. Mutations in *FUS/TLS* have been reported in ~4% of the FALS patients,<sup>75</sup> but downstream effects and transcriptomes are still unknown. We have utilized RNA-Seq to investigate the normal function of *FUS/TLS*, and to identify the spectrum of RNA targets. RNA-Seq is a novel technique based on short-read high-throughput sequencing of the transcriptome, which involves conversion to cDNA fragments with adaptors followed by next-generation sequencing of the products, resulting in millions of reads.<sup>76</sup> This allows construction of a genome-scale transcription map composed of the transcriptional structure and/or the level of expression of each gene.<sup>76</sup> Our results will provide additional insights into the role of *FUS/TLS* in the pathogenesis of ALS.

**Chapter 18** will discuss TDP-43. While *TARDBP* mutations have been detected in approximately five percent of the patients with FALS,<sup>77-106</sup> TDP-43-positive inclusions are a hallmark of ALS.<sup>37</sup> To investigate a possible genotype (*TARDBP* gene mutations) -

phenotype (plasma TDP-43 levels) relation, we performed an ELISA to investigate TDP-43 plasma levels. Moreover, we tested the potential of these plasma levels as a biomarker.

Hereafter, we will focus *SOD1*. More than 160 *SOD1* mutations have been reported to date (<http://alsod.iop.kcl.ac.uk/index.aspx>). These mutations probably affect the susceptibility to oxidation-induced misfolding, and result in mutant specific protein interactions, and/or altered subcellular localization, eventually leading to the formation of aggregates and inclusion bodies.<sup>107-110</sup> An interesting method to reduce the toxic effects of extracellular modified SOD1 would be to use specific antibodies. Immunization and immunotherapy have already been tested in mouse models, and appeared to be beneficial.<sup>111-113</sup> To our best knowledge, the presence of SOD1 antibodies in human serum has not yet been investigated, nor have the effects of these antibodies been verified in humans. Therefore, in **Chapter 19**, we describe the development of an ELISA to detect anti-SOD1 antibodies in human serum.

The last chapter (**Chapter 20**), will provide an overview of all genes discussed in this thesis. Moreover, we will summarize the clinical characteristics, the distribution, and the possible effects of mutations in these eleven genes.

*“I do hope I will not develop ALS, nevertheless, ALS already plays a major role in my life. We do need to raise more money and invest in the development of new treatment strategies for ALS. I am sincerely hoping they will find a cure for ALS, and that my father and my aunt will be able to celebrate that moment with us.”*

## References

- (1) Huisman MH, de Jong SW, van Doormaal PT et al. Population based epidemiology of amyotrophic lateral sclerosis using capture-recapture methodology. *J Neurol Neurosurg Psychiatry* 2011;82:1165-1170.
- (2) Miller RG, Mitchell JD, Lyon M, Moore DH. Riluzole for amyotrophic lateral sclerosis (ALS)/motor neuron disease (MND). *Cochrane Database Syst Rev* 2007;CD001447.
- (3) Byrne S, Walsh C, Lynch C et al. Rate of familial amyotrophic lateral sclerosis: a systematic review and meta-analysis. *J Neurol Neurosurg Psychiatry* 2011;82:623-627.
- (4) Rosen DR, Siddique T, Patterson D et al. Mutations in Cu/Zn superoxide dismutase gene are associated with familial amyotrophic lateral sclerosis. *Nature* 1993;362:59-62.



- (5) Aldridge WN. Serum esterases. I. Two types of esterase (A and B) hydrolysing p-nitrophenyl acetate, propionate and butyrate, and a method for their determination. *Biochem J* 1953;53:110-117.
- (6) Aldridge WN. Serum esterases. II. An enzyme hydrolysing diethyl p-nitrophenyl phosphate (E600) and its identity with the A-esterase of mammalian sera. *Biochem J* 1953;53:117-124.
- (7) Scacchi R, Gambina G, Martini MC, Broggio E, Vilardo T, Corbo RM. Different pattern of association of paraoxonase Gln192-->Arg polymorphism with sporadic late-onset Alzheimer's disease and coronary artery disease. *Neurosci Lett* 2003;339:17-20.
- (8) Zintzaras E, Hadjigeorgiou GM. Association of paraoxonase 1 gene polymorphisms with risk of Parkinson's disease: a meta-analysis. *J Hum Genet* 2004;49:474-481.
- (9) Leduc V, Poirier J. Polymorphisms at the paraoxonase 1 L55M and Q192R loci affect the pathophysiology of Alzheimer's disease: emphasis on the cholinergic system and beta-amyloid levels. *Neurodegener Dis* 2008;5:225-227.
- (10) Sidoti A, Antognelli C, Rinaldi C et al. Glyoxalase I A111E, paraoxonase 1 Q192R and L55M polymorphisms: susceptibility factors of multiple sclerosis? *Mult Scler* 2007;13:446-453.
- (11) Chapuis J, Boscher M, Bensemain F, Cottel D, Amouyel P, Lambert JC. Association study of the paraoxonase 1 gene with the risk of developing Alzheimer's disease. *Neurobiol Aging* 2009;30:152-156.
- (12) Erlich PM, Lunetta KL, Cupples LA et al. Polymorphisms in the PON gene cluster are associated with Alzheimer disease. *Hum Mol Genet* 2006;15:77-85.
- (13) Rose MR. Gulf War service is an uncertain trigger for ALS. *Neurology* 2003;61:730-731.
- (14) Barohn RJ, Rowland LP. Neurology and Gulf War veterans. *Neurology* 2002;59:1484-1485.
- (15) Haley RW. Excess incidence of ALS in young Gulf War veterans. *Neurology* 2003;61:750-756.
- (16) Horner RD, Kamins KG, Feussner JR et al. Occurrence of amyotrophic lateral sclerosis among Gulf War veterans. *Neurology* 2003;61:742-749.
- (17) Valdmanis PN, Kabashi E, Dyck A et al. Association of paraoxonase gene cluster polymorphisms with ALS in France, Quebec, and Sweden. *Neurology* 2008;71:514-520.
- (18) Cronin S, Greenway MJ, Prehn JH, Hardiman O. Paraoxonase promoter and intronic variants modify risk of sporadic amyotrophic lateral sclerosis. *J Neurol Neurosurg Psychiatry* 2007;78:984-986.
- (19) Morahan JM, Yu B, Trent RJ, Pamphlett R. A gene-environment study of the paraoxonase 1 gene and pesticides in amyotrophic lateral sclerosis. *Neurotoxicology* 2007;28:532-540.
- (20) Slowik A, Tomik B, Wolkow PP et al. Paraoxonase gene polymorphisms and sporadic ALS. *Neurology* 2006;67:766-770.
- (21) Saeed M, Siddique N, Hung WY et al. Paraoxonase cluster polymorphisms are associated with sporadic ALS. *Neurology* 2006;67:771-776.
- (22) Landers JE, Shi L, Cho TJ et al. A common haplotype within the PON1 promoter region is associated with sporadic ALS. *Amyotroph Lateral Scler* 2008;9:306-314.

- (23) Wills AM, Cronin S, Slowik A et al. A large-scale international meta-analysis of paraoxonase gene polymorphisms in sporadic ALS. *Neurology* 2009;73:16-24.
- (24) Maruyama H, Morino H, Ito H et al. Mutations of optineurin in amyotrophic lateral sclerosis. *Nature* 2010;465:223-226.
- (25) Hattula K, Peranen J. FIP-2, a coiled-coil protein, links Huntingtin to Rab8 and modulates cellular morphogenesis. *Curr Biol* 2000;10:1603-1606.
- (26) Sahlender DA, Roberts RC, Arden SD et al. Optineurin links myosin VI to the Golgi complex and is involved in Golgi organization and exocytosis. *J Cell Biol* 2005;169:285-295.
- (27) Weisschuh N, Alavi MV, Bonin M, Wissinger B. Identification of genes that are linked with optineurin expression using a combined RNAi--microarray approach. *Exp Eye Res* 2007;85:450-461.
- (28) Anborgh PH, Godin C, Pampillo M et al. Inhibition of metabotropic glutamate receptor signaling by the huntingtin-binding protein optineurin. *J Biol Chem* 2005;280:34840-34848.
- (29) Li Y, Kang J, Horwitz MS. Interaction of an adenovirus E3 14.7-kilodalton protein with a novel tumor necrosis factor alpha-inducible cellular protein containing leucine zipper domains. *Mol Cell Biol* 1998;18:1601-1610.
- (30) Moreland RJ, Dresser ME, Rodgers JS et al. Identification of a transcription factor IIIA-interacting protein. *Nucleic Acids Res* 2000;28:1986-1993.
- (31) Wild P, Farhan H, McEwan DG et al. Phosphorylation of the autophagy receptor optineurin restricts Salmonella growth. *Science* 2011;333:228-233.
- (32) Johnson JO, Mandrioli J, Benatar M et al. Exome sequencing reveals VCP mutations as a cause of familial ALS. *Neuron* 2010;68:857-864.
- (33) Watts GD, Wymer J, Kovach MJ et al. Inclusion body myopathy associated with Paget disease of bone and frontotemporal dementia is caused by mutant valosin-containing protein. *Nat Genet* 2004;36:377-381.
- (34) Weihl CC, Pestronk A, Kimonis VE. Valosin-containing protein disease: inclusion body myopathy with Paget's disease of the bone and fronto-temporal dementia. *Neuromuscul Disord* 2009;19:308-315.
- (35) Deng HX, Chen W, Hong ST et al. Mutations in UBQLN2 cause dominant X-linked juvenile and adult-onset ALS and ALS/dementia. *Nature* 2011;477:211-215.
- (36) Fecto F, Siddique T. UBQLN2/P62 cellular recycling pathways in amyotrophic lateral sclerosis and frontotemporal dementia. *Muscle Nerve* 2012;45:157-162.
- (37) Neumann M, Sampathu DM, Kwong LK et al. Ubiquitinated TDP-43 in frontotemporal lobar degeneration and amyotrophic lateral sclerosis. *Science* 2006;314:130-133.
- (38) Elden AC, Kim HJ, Hart MP et al. Ataxin-2 intermediate-length polyglutamine expansions are associated with increased risk for ALS. *Nature* 2010;466:1069-1075.
- (39) Lastres-Becker I, Rub U, Auburger G. Spinocerebellar ataxia 2 (SCA2). *Cerebellum* 2008;7:115-124.

- (40) Renton AE, Majounie E, Waite A et al. A Hexanucleotide Repeat Expansion in C9ORF72 Is the Cause of Chromosome 9p21-Linked ALS-FTD. *Neuron* 2011;72:257-268.
- (41) DeJesus-Hernandez M, Mackenzie IR, Boeve BF et al. Expanded GGGGCC Hexanucleotide Repeat in Noncoding Region of C9ORF72 Causes Chromosome 9p-Linked FTD and ALS. *Neuron* 2011;72:245-256.
- (42) Morita M, Al-Chalabi A, Andersen PM et al. A locus on chromosome 9p confers susceptibility to ALS and frontotemporal dementia. *Neurology* 2006;66:839-844.
- (43) Pearson JP, Williams NM, Majounie E et al. Familial frontotemporal dementia with amyotrophic lateral sclerosis and a shared haplotype on chromosome 9p. *J Neurol* 2011;258:647-655.
- (44) Gijssels I, Engelborghs S, Maes G et al. Identification of 2 Loci at chromosomes 9 and 14 in a multiplex family with frontotemporal lobar degeneration and amyotrophic lateral sclerosis. *Arch Neurol* 2010;67:606-616.
- (45) Boxer AL, Mackenzie IR, Boeve BF et al. Clinical, neuroimaging and neuropathological features of a new chromosome 9p-linked FTD-ALS family. *J Neurol Neurosurg Psychiatry* 2011;82:196-203.
- (46) Vance C, Al-Chalabi A, Ruddy D et al. Familial amyotrophic lateral sclerosis with frontotemporal dementia is linked to a locus on chromosome 9p13.2-21.3. *Brain* 2006;129:868-876.
- (47) Valdmanis PN, Dupre N, Bouchard JP et al. Three families with amyotrophic lateral sclerosis and frontotemporal dementia with evidence of linkage to chromosome 9p. *Arch Neurol* 2007;64:240-245.
- (48) Le Ber I, Camuzat A, Berger E et al. Chromosome 9p-linked families with frontotemporal dementia associated with motor neuron disease. *Neurology* 2009;72:1669-1676.
- (49) Luty AA, Kwok JB, Thompson EM et al. Pedigree with frontotemporal lobar degeneration--motor neuron disease and Tar DNA binding protein-43 positive neuropathology: genetic linkage to chromosome 9. *BMC Neurol* 2008;8:32.
- (50) Kanekura K, Suzuki H, Aiso S, Matsuoka M. ER stress and unfolded protein response in amyotrophic lateral sclerosis. *Mol Neurobiol* 2009;39:81-89.
- (51) Lev S, Ben HD, Peretti D, Dahan N. The VAP protein family: from cellular functions to motor neuron disease. *Trends Cell Biol* 2008;18:282-290.
- (52) Gkogkas C, Middleton S, Kremer AM et al. VAPB interacts with and modulates the activity of ATF6. *Hum Mol Genet* 2008;17:1517-1526.
- (53) Moumen A, Virard I, Raoul C. Accumulation of wildtype and ALS-linked mutated VAPB impairs activity of the proteasome. *PLoS One* 2011;6:e26066.
- (54) Nishimura AL, Mitne-Neto M, Silva HC et al. A mutation in the vesicle-trafficking protein VAPB causes late-onset spinal muscular atrophy and amyotrophic lateral sclerosis. *Am J Hum Genet* 2004;75:822-831.
- (55) Chen HJ, Anagnostou G, Chai A et al. Characterization of the properties of a novel mutation in VAPB in familial amyotrophic lateral sclerosis. *J Biol Chem* 2010;285:40266-40281.
- (56) Rowland LP. Progressive muscular atrophy and other lower motor neuron syndromes of adults. *Muscle Nerve* 2010;41:161-165.

- (57) Van Den Berg-Vos RM, Visser J, Franssen H et al. Sporadic lower motor neuron disease with adult onset: classification of subtypes. *Brain* 2003;126:1036-1047.
- (58) Van Den Berg-Vos RM, van den Berg LH, Visser J, de Visser M, Franssen H, Wokke JH. The spectrum of lower motor neuron syndromes. *J Neurol* 2003;250:1279-1292.
- (59) Visser J, Van Den Berg-Vos RM, Franssen H et al. Disease course and prognostic factors of progressive muscular atrophy. *Arch Neurol* 2007;64:522-528.
- (60) Traynor BJ, Codd MB, Corr B, Forde C, Frost E, Hardiman OM. Clinical features of amyotrophic lateral sclerosis according to the El Escorial and Airlie House diagnostic criteria: A population-based study. *Arch Neurol* 2000;57:1171-1176.
- (61) Kim WK, Liu X, Sandner J et al. Study of 962 patients indicates progressive muscular atrophy is a form of ALS. *Neurology* 2009;73:1686-1692.
- (62) Cudkovicz ME, McKenna-Yasek D, Chen C, Hedley-Whyte ET, Brown RH, Jr. Limited corticospinal tract involvement in amyotrophic lateral sclerosis subjects with the A4V mutation in the copper/zinc superoxide dismutase gene. *Ann Neurol* 1998;43:703-710.
- (63) Ince PG, Lowe J, Shaw PJ. Amyotrophic lateral sclerosis: current issues in classification, pathogenesis and molecular pathology. *Neuropathol Appl Neurobiol* 1998;24:104-117.
- (64) Ince PG, Evans J, Knopp M et al. Corticospinal tract degeneration in the progressive muscular atrophy variant of ALS. *Neurology* 2003;60:1252-1258.
- (65) Geser F, Stein B, Partain M et al. Motor neuron disease clinically limited to the lower motor neuron is a diffuse TDP-43 proteinopathy. *Acta Neuropathol* 2011;121:509-517.
- (66) Parkinson N, Ince PG, Smith MO et al. ALS phenotypes with mutations in CHMP2B (charged multivesicular body protein 2B). *Neurology* 2006;67:1074-1077.
- (67) Cox LE, Ferraiuolo L, Goodall EF et al. Mutations in CHMP2B in lower motor neuron predominant amyotrophic lateral sclerosis (ALS). *PLoS One* 2010;5:e9872.
- (68) Skibinski G, Parkinson NJ, Brown JM et al. Mutations in the endosomal ESCRTIII-complex subunit CHMP2B in frontotemporal dementia. *Nat Genet* 2005;37:806-808.
- (69) Auer-Grumbach M, Olschewski A, Papic L et al. Alterations in the ankyrin domain of TRPV4 cause congenital distal SMA, scapuloperoneal SMA and HMSN2C. *Nat Genet* 2010;42:160-164.
- (70) Deng HX, Klein CJ, Yan J et al. Scapuloperoneal spinal muscular atrophy and CMT2C are allelic disorders caused by alterations in TRPV4. *Nat Genet* 2010;42:165-169.
- (71) Landouere G, Zdebik AA, Martinez TL et al. Mutations in TRPV4 cause Charcot-Marie-Tooth disease type 2C. *Nat Genet* 2010;42:170-174.
- (72) Zimon M, Baets J, Auer-Grumbach M et al. Dominant mutations in the cation channel gene transient receptor potential vanilloid 4 cause an unusual spectrum of neuropathies. *Brain* 2010;133:1798-1809.
- (73) Nakashima-Yasuda H, Uryu K, Robinson J et al. Co-morbidity of TDP-43 proteinopathy in Lewy body related diseases. *Acta Neuropathol* 2007;114:221-229.

- (74) Quadri M, Cossu G, Saddi V et al. Broadening the phenotype of TARDBP mutations: the TARDBP Ala382Thr mutation and Parkinson's disease in Sardinia. *Neurogenetics* 2011;12:203-209.
- (75) Mackenzie IR, Rademakers R, Neumann M. TDP-43 and FUS in amyotrophic lateral sclerosis and frontotemporal dementia. *Lancet Neurol* 2010;9:995-1007.
- (76) Wang Z, Gerstein M, Snyder M. RNA-Seq: a revolutionary tool for transcriptomics. *Nat Rev Genet* 2009;10:57-63.
- (77) Benajiba L, Le Ber I, Camuzat A et al. TARDBP mutations in motoneuron disease with frontotemporal lobar degeneration. *Ann Neurol* 2009;65:470-473.
- (78) Corrado L, Ratti A, Gellera C et al. High frequency of TARDBP gene mutations in Italian patients with amyotrophic lateral sclerosis. *Hum Mutat* 2009;30:688-694.
- (79) Daoud H, Valdmanis PN, Kabashi E et al. Contribution of TARDBP mutations to sporadic amyotrophic lateral sclerosis. *J Med Genet* 2009;46:112-114.
- (80) Del Bo R, Ghezzi S, Corti S et al. TARDBP (TDP-43) sequence analysis in patients with familial and sporadic ALS: identification of two novel mutations. *Eur J Neurol* 2009;16:727-732.
- (81) Gitcho MA, Baloh RH, Chakraverty S et al. TDP-43 A315T mutation in familial motor neuron disease. *Ann Neurol* 2008;63:535-538.
- (82) Kabashi E, Valdmanis PN, Dion P et al. TARDBP mutations in individuals with sporadic and familial amyotrophic lateral sclerosis. *Nat Genet* 2008;40:572-574.
- (83) Kamada M, Maruyama H, Tanaka E et al. Screening for TARDBP mutations in Japanese familial amyotrophic lateral sclerosis. *J Neurol Sci* 2009;284:69-71.
- (84) Kirby J, Goodall EF, Smith W et al. Broad clinical phenotypes associated with TAR-DNA binding protein (TARDBP) mutations in amyotrophic lateral sclerosis. *Neurogenetics* 2010;11:217-225.
- (85) Kuhnlein P, Sperfeld AD, Vanmassenhove B et al. Two German kindreds with familial amyotrophic lateral sclerosis due to TARDBP mutations. *Arch Neurol* 2008;65:1185-1189.
- (86) Origone P, Caponnetto C, Bandettini Di Poggio M et al. Enlarging clinical spectrum of FALS with TARDBP gene mutations: S393L variant in an Italian family showing phenotypic variability and relevance for genetic counselling. *Amyotroph Lateral Scler* 2010;11:223-227.
- (87) Rutherford NJ, Zhang YJ, Baker M et al. Novel mutations in TARDBP (TDP-43) in patients with familial amyotrophic lateral sclerosis. *PLoS Genet* 2008;4:e1000193.
- (88) Sreedharan J, Blair IP, Tripathi VB et al. TDP-43 mutations in familial and sporadic amyotrophic lateral sclerosis. *Science* 2008;319:1668-1672.
- (89) Van Deerlin VM, Leverenz JB, Bekris LM et al. TARDBP mutations in amyotrophic lateral sclerosis with TDP-43 neuropathology: a genetic and histopathological analysis. *Lancet Neurol* 2008;7:409-416.
- (90) Xiong HL, Wang JY, Sun YM et al. Association between novel TARDBP mutations and Chinese patients with amyotrophic lateral sclerosis. *BMC Med Genet* 2010;11:8.

- (91) Williams KL, Durnall JC, Thoeng AD, Warraich ST, Nicholson GA, Blair IP. A novel TARDBP mutation in an Australian amyotrophic lateral sclerosis kindred. *J Neurol Neurosurg Psychiatry* 2009;80:1286-1288.
- (92) Yokoseki A, Shiga A, Tan CF et al. TDP-43 mutation in familial amyotrophic lateral sclerosis. *Ann Neurol* 2008;63:538-542.
- (93) Lemmens R, Race V, Hersmus N et al. TDP-43 M311V mutation in familial amyotrophic lateral sclerosis. *J Neurol Neurosurg Psychiatry* 2009;80:354-355.
- (94) Chio A, Calvo A, Moglia C et al. Amyotrophic lateral sclerosis-frontotemporal lobar dementia in 3 families with p.Ala382Thr TARDBP mutations. *Arch Neurol* 2010;67:1002-1009.
- (95) Chio A, Borghero G, Pugliatti M et al. Large Proportion of Amyotrophic Lateral Sclerosis Cases in Sardinia Due to a Single Founder Mutation of the TARDBP Gene. *Arch Neurol* 2011;68:594-598.
- (96) Millecamps S, Salachas F, Cazeneuve C et al. SOD1, ANG, VAPB, TARDBP, and FUS mutations in familial amyotrophic lateral sclerosis: genotype-phenotype correlations. *J Med Genet* 2010;47:554-560.
- (97) Nozaki I, Arai M, Takahashi K et al. Familial ALS with G298S mutation in TARDBP: a comparison of CSF tau protein levels with those in sporadic ALS. *Intern Med* 2010;49:1209-1212.
- (98) Tamaoka A, Arai M, Itokawa M et al. TDP-43 M337V mutation in familial amyotrophic lateral sclerosis in Japan. *Intern Med* 2010;49:331-334.
- (99) Ticozzi N, Leclerc AL, van Blitterswijk M et al. Mutational analysis of TARDBP in neurodegenerative diseases. *Neurobiol Aging* 2011;32:2096-2099.
- (100) Tsai CP, Soong BW, Lin KP, Tu PH, Lin JL, Lee YC. FUS, TARDBP, and SOD1 mutations in a Taiwanese cohort with familial ALS. *Neurobiol Aging* 2011;32:553.e13-e21.
- (101) Baumer D, Parkinson N, Talbot K. TARDBP in amyotrophic lateral sclerosis: identification of a novel variant but absence of copy number variation. *J Neurol Neurosurg Psychiatry* 2009;80:1283-1285.
- (102) Conforti FL, Sproviero W, Simone IL et al. TARDBP gene mutations in south Italian patients with amyotrophic lateral sclerosis. *J Neurol Neurosurg Psychiatry* 2011;82:587-588.
- (103) Huang R, Fang DF, Ma MY et al. TARDBP gene mutations among Chinese patients with sporadic amyotrophic lateral sclerosis. *Neurobiol Aging* 2010 Aug 12.
- (104) Iida A, Kamei T, Sano M et al. Large-scale screening of TARDBP mutation in amyotrophic lateral sclerosis in Japanese. *Neurobiol Aging* 2012;33:786-790.
- (105) Gijssels I, Sleegers K, Engelborghs S et al. Neuronal inclusion protein TDP-43 has no primary genetic role in FTD and ALS. *Neurobiol Aging* 2009;30:1329-1331.









# **PART I**

**Genetic studies;  
amyotrophic lateral sclerosis**



# 2

**“I gladly offer what occurs to me in this matter and submit it to the judgment and censure of right-thinking men.”**

Galileo Galilei, Sidereus Nuncius.

# Paraoxonase gene mutations in amyotrophic lateral sclerosis

Nicola Ticozzi, Ashley Lyn LeClerc, Pamela Keagle, Jonathan D. Glass, Anne-Marie Wills, Marka van Blitterswijk, Daryl A. Bosco, Ildefonso Rodriguez-Leyva, Cinzia Gellera, Antonia Ratti, Franco Taroni, Diane M. McKenna-Yasek, Peter C. Sapp, Vincenzo Silani, Clement E. Furlong, Robert H. Brown Jr., John E. Landers

## Abstract

Three clustered, homologous paraoxonase genes (*PON1*, *PON2*, and *PON3*) have roles in preventing lipid oxidation and detoxifying organophosphates. Recent reports describe a genetic association between the *PON* genes and sporadic amyotrophic lateral sclerosis (ALS). We now report that in genomic DNA from individuals with familial and sporadic ALS, we have identified at least seven *PON* gene mutations that are predicted to alter PON function.

## Introduction

The paraoxonase gene cluster (*PON*) consists of three adjacent genes on chromosome 7q21.3-q22.1. Of these, *PON1* is the most intensively studied. *PON1* and *PON3* are primarily expressed in the liver and secreted into the blood through their association with high-density lipoprotein (HDL); in contrast, *PON2* is ubiquitously expressed.<sup>1</sup> The interaction of *PON1* with HDL requires the amino terminal retained signal sequence of the *PON1* protein.<sup>2</sup> Almost all serum *PON1* protein is bound to HDL.<sup>3</sup> *PON1* has a broad spectrum of substrates, including organophosphates (paraoxon, chlorpyrifos oxon, and diazoxon), nerve toxins (soman and sarin), and aromatic esters (phenyl acetate).<sup>1</sup> Several organophosphate compounds are neurotoxins commonly found in insecticides, nerve agents, foods, and other household items. The ability to detoxify organophosphates is not shared by *PON2* or *PON3*.<sup>4,5</sup> Because organophosphates are not produced in the body, it is postulated that the physiological function of *PON1* is to protect low-density lipoprotein from oxidation.<sup>6</sup> All three *PON* proteins share the ability to hydrolyze lactones (cyclic esters).<sup>7</sup> Because the *PON* proteins reduce oxidation and detoxify neurotoxins, the *PON* cluster has been intensively studied for a possible role in amyotrophic lateral sclerosis (ALS). Six studies have shown a genetic association between single nucleotide polymorphisms (SNPs) in the *PON* genes and sporadic ALS,<sup>8-13</sup> although a meta-analysis of all published data failed to detect this association.<sup>14</sup> To extend these studies, we have sequenced the *PON* genes in familial and sporadic ALS (FALS and SALS) cases to identify potentially causal mutations.

## Subjects and methods

All samples were collected with Institutional Review Board approval. The FALS cases were previously screened for mutations in superoxide dismutase-1 (*SOD1*), TAR DNA-binding protein (*TARDBP*), and fused in sarcoma / translated in liposarcoma (*FUS/TLS*), and consisted of 255 Caucasians (97.3%), three Asians (1.2%), one African American (0.38%), and one sample of mixed origin (0.38%). All SALS cases and control samples were Caucasian in origin. The coding regions of each *PON* gene were amplified using primers located in adjacent intronic or non-coding regions. Primer sequences are reported in Supplementary Table 2.1. Polymerase chain reactions were bi-directionally sequenced and aligned, and variations were identified with Polyphred software. Genotyping was performed using custom Taqman SNP Genotyping Assays (Applied Biosystems, Foster City, CA). Primer and probe sequences are reported in Supplementary Table 2.2. All samples displaying the mutant genotype were confirmed by bi-directional DNA sequencing. A more extensive description of the methods is available in Supplementary Materials and methods.

## Results

To identify DNA mutations that predispose to ALS, we sequenced the coding region of *PON1* in 260 FALS and 188 SALS cases. Our analysis revealed eight heterozygous rare variants in fifteen case samples; seven variants were not present in SNP database (dbSNP) build 130, whereas one (c.269T>C) is reported as rs72552788. We presume that this SNP is rare, inasmuch as it was not detected in 591 control DNA samples included in the SNP500 Cancer Database (<http://snp500cancer.nci.nih.gov>); moreover, no allele frequencies for this SNP are reported in dbSNP. Sequencing of *PON1* in 188 controls and 188 SALS did not reveal additional rare variants. To test further the possibility that these SNPs are benign polymorphisms, we genotyped each of the eight variants by TaqMan SNP assays in a panel of 1,159 control DNA samples and an additional set of 996 SALS DNAs. Five of the eight mutations were not present in control samples, suggesting that they contribute to ALS pathogenesis (Table 2.1). Three variants were detected in controls (p.N19D, p.M127R, and p.A201V) with a frequency ~50% lower than cases; these variants demonstrated a low to moderate level of evolutionary conservation (Supplementary Figure 2.1).

Four of the mutations identified only in ALS cases are missense: p.C42R, p.L90P, p.M127I, and p.P315T. The p.M127I site displays evolutionary variation at this position. Because the p.M127R variant was identified in control samples, this change may likely reflect a benign polymorphism. In contrast, the wild-type residue for the remaining missense changes is highly conserved across multiple species, including zebrafish (Figure 2.1). Given that *PON1* contains a single disulfide bridge between Cys42 and Cys353, and that this is required for *PON1* activity,<sup>35</sup> it is predicted that the p.C42R mutant will disrupt the bridge and impair *PON1* function. The p.L90P and p.P315T mutations create or destroy a proline residue, which contains a ring structure with conformational rigidity that can destroy  $\alpha$ -helices. Based on these properties, we expect these mutations to change *PON1* protein folding. The fourth mutation (c.74+3A>C) disrupts the 5' human splice consensus sequence MAG|GTRAGT. The purine (R) base is present in 94% of splice sites and is highly evolutionarily conserved in *PON1* (see Figure 2.1). The substitution with a pyrimidine will likely alter the primary sequence or expression of the *PON1* protein. Cell lines and tissue were not available to directly assess the influence of this mutation. Additional DNA was available from an affected sibling of a FALS case harboring the p.P315T mutation. Genotyping demonstrated that the affected sibling also carries the mutation. DNA was not available from any other affected family members (Supplementary Table 2.3 and Supplementary Figure 2.2). All five mutations were observed in FALS, whereas only one mutation, p.L90P, was also observed in a single SALS case. These results suggest that mutations in *PON1* contribute more significantly to FALS than SALS. There was also

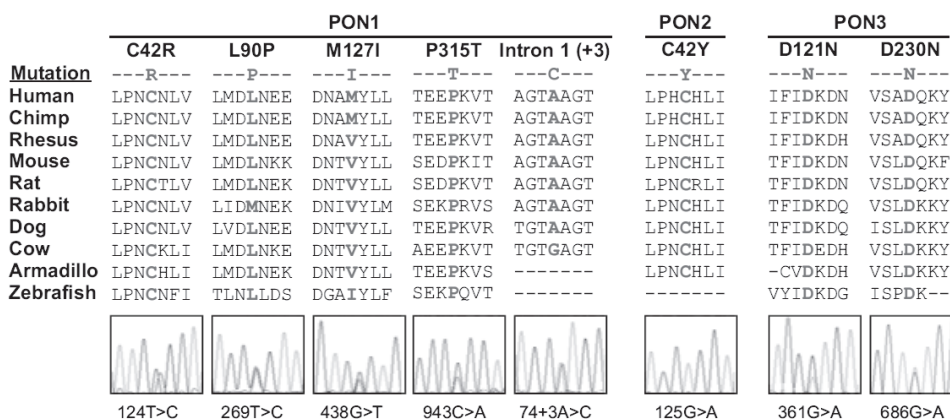
**Table 2.1** Paraoxonase gene variants in familial and sporadic ALS

| Gene                      | Exon | Bp Change | Variant, ALS only | Variant dose | Direct sequencing |       |         |        | Total    |          |
|---------------------------|------|-----------|-------------------|--------------|-------------------|-------|---------|--------|----------|----------|
|                           |      |           |                   |              | FALS              | SALS  | Control | FALS   | SALS     | Control  |
| PON1                      | 1    | c.74+3A>C | Intron 1 (+3)     | Heterozygous | 1/260             | 0/188 | 0/188   | 1/260  | 0/1,184  | 0/1,159  |
| PON1                      | 2    | c.124T>C  | p.C42R            | Heterozygous | 1/260             | 0/188 | 0/188   | 1/260  | 0/1,184  | 0/1,159  |
| PON1                      | 4    | c.269T>C  | p.L90P            | Heterozygous | 1/260             | 0/188 | 0/188   | 1/260  | 1/1,184  | 0/1,159  |
| PON1                      | 5    | c.438G>T  | p.M127I           | Heterozygous | 1/260             | 0/188 | 0/188   | 1/260  | 0/1,184  | 0/1,159  |
| PON1                      | 9    | c.943C>A  | p.P315T           | Heterozygous | 1/260             | 0/188 | 0/188   | 1/260  | 0/1,184  | 0/1,159  |
| PON2                      | 2    | c.125G>A  | p.C42Y            | Homozygous   | 1/166             |       |         | 1/260  | 0/1,184  | 0/1,159  |
| PON3                      | 4    | c.361G>A  | p.D121N           | Heterozygous | 1/166             |       |         | 1/260  | 1/1,184  | 0/1,159  |
| PON3                      | 6    | c.688G>A  | p.D230N           | Heterozygous | 1/166             |       |         | 2/260  | 1/1,184  | 0/1,159  |
| Subtotal                  |      |           |                   |              |                   |       |         | 9/260  | 3/1,184  | 0/1,159  |
| Variant, ALS and controls |      |           |                   |              |                   |       |         |        |          |          |
| PON1                      | 1    | c.55A>G   | p.N19D            | Heterozygous | 2/260             | 0/188 | 1/188   | 2/260  | 6/1,184  | 3/1,159  |
| PON1                      | 5    | c.437T>G  | p.M127R           | Heterozygous | 2/260             | 1/188 | 0/188   | 2/260  | 6/1,184  | 2/1,159  |
| PON1                      | 6    | c.602C>T  | p.A201V           | Heterozygous | 4/260             | 0/188 | 1/188   | 4/260  | 3/1,184  | 3/1,159  |
| PON2                      | 4    | c.286delA | p.R96GfsX5        | Heterozygous | 1/166             | -     | -       | 1/260  | 6/1,184  | 4/1,159  |
| PON3                      | 9    | c.971G>A  | p.G324D           | Heterozygous | 2/166             | -     | -       | 2/260  | 1/1,184  | 3/1,159  |
| Subtotal                  |      |           |                   |              |                   |       |         | 11/260 | 22/1,184 | 15/1,159 |
| Total                     |      |           |                   |              |                   |       |         | 20/260 | 25/1,184 | 15/1,159 |

Abbreviations: bp = base pair, ALS = amyotrophic lateral sclerosis, FALS = familial ALS, and SALS = sporadic ALS.

no ethnic commonality between the mutated samples (see Supplementary Table 2.3), suggesting that alteration to *PON1* is not unique to a single population.

We also sequenced the *PON2* and *PON3* genes in 166 FALS cases and identified five novel variants (two in *PON2* and three in *PON3*; see Table 2.1 and Supplementary Table 2.3). As in the studies of *PON1*, we evaluated the ALS specificity of these variants by genotyping each in a panel of 1,159 control and 1,184 SALS DNA samples, as well as an additional 94 FALS samples. One *PON2* mutation, p.C42Y, was not identified in control samples (see Table 2.1). This mutation was homozygous in a proband whose parents were asymptomatic first cousins, strongly suggesting a recessive model of inheritance. The mutated residue corresponds to the p.C42R mutation identified in *PON1*, suggesting that this amino acid is of critical importance to PON function. Additionally, two of three novel *PON3* mutations were not observed in control samples, but were identified in SALS, suggesting that they also contribute to ALS pathogenesis. In particular, a p.D230N mutation was observed in two distinct FALS cases and a single SALS case. The identification of this mutation in two unrelated FALS cases further suggests that this variant is pathogenic. In all three cases, the *PON2* and *PON3* mutations were highly conserved, further highlighting the importance of the mutated amino acids (see Figure 2.1). We also detected a frameshift variant in *PON2* (c.286delA, p.R96GfxX5; see Supplementary Table 2.3) that is predicted to generate a truncated *PON2* protein of 101



**Figure 2.1** Evolutionary conservation of *PON* mutations in familial and sporadic amyotrophic lateral sclerosis. This illustrates the evolutionary conservation of the amino acids implicated by the eight identified mutations. For each, the mutated amino acid (or nucleotide for the splicing mutation) is shown in red. Chromatograms displaying the mutation are shown below. The position indicates the base pair position within the cDNA. All mutations were heterozygous except for the homozygous p.C42Y *PON2* mutation. Each mutation was confirmed by bi-directional sequencing and 5' nuclease assay genotyping. See Appendix page 378 for Figure 2.1 in color.



amino acids. Because this was heterozygously present in FALS (1/260), SALS (6/1,184), and controls (4/1,159), it is likely to be a benign polymorphism.

In total, from nine FALS and three SALS cases we identified eight coding sequence mutations that were present in the *PON* genes but not in controls. The overall percentage of *PON* gene mutations in our FALS panel was approximately 3.5%. Because our panel excluded all cases with *SOD1*, *TARDBP*, and *FUS/TLS* mutations, which represent ~30% of all FALS, we estimate that mutations in the *PON* gene cluster represent ~2.5% of all FALS cases.

## Discussion

The hydrolytic activity of PON1 varies substantially (8- to 10-fold) depending on the genotype of *PON1* coding SNPs in the population, and is influenced by exogenous factors, including smoking, diet, and lipid-controlling medication.<sup>1</sup> Given this wide variation in hydrolytic activity, we presume that if the *PON1* mutations predispose to ALS by reducing hydrolysis, such activity reductions must be severe. This suggests that the *PON1* mutants may act as dominant negative inhibitors by oligomerizing and inactivating wild-type PON1. This view is consistent with the observations that native PON1 may exist in multiple oligomeric states,<sup>16;17</sup> as predicted by its variable molecular mass (70–500 kDa). Oligomerization is promoted by the interaction of the *PON1* amino terminal region with HDL particles.<sup>16</sup> That these *PON1* mutations exert a dominant negative influence on PON1 activity is consistent with a report that serum from an individual with a heterozygous p.L90P *PON1* mutation showed profoundly reduced hydrolysis of diazoxon and paraoxon.<sup>18</sup>

Because its activity, pattern of expression, localization, and incorporation into HDL mimics that of PON1, it is possible that the adverse consequences of *PON3* mutants will be mechanistically similar to those of mutant forms of PON1. It is therefore of interest that the ALS-associated variants in both *PON1* and *PON3* are present on only one allele; heterozygous variants in either gene are potentially able to inhibit activity via a dominant negative mechanism. By contrast, *PON2* is an intracellular enzyme that does not interact with HDL and that exists in a predominantly monomeric state. That an apparently benign, heterozygous frameshift mutation in *PON2* is present within the general population argues that haploinsufficiency of *PON2* is not obviously pathogenic. In turn, this argues that the *PON2* mutants will only be pathogenic when they lead to more profound loss of function than is predicted by eliminating one functional *PON2* allele. This prediction is consistent with our finding that the ALS-associated variant in *PON2* is present as a homozygous defect.

As with all genetically based studies, the possibility exists that the identified changes represent rare variants as opposed to pathogenic mutations. This is especially true when the approach is based on candidate gene sequencing as opposed to linkage analysis. However, several lines of evidence suggest that the changes reported here are indeed pathogenic. With the exception of the *PON1* p.M127I, all of the amino acid residues modified by the ALS-specific variants show a high level of evolutionary conservation. In particular, the *PON1* p.C42R mutation (and presumably, by homology, the *PON2* p.C42Y mutation) destroys a cysteine bond essential for activity. Furthermore, the p.L90P has been previously identified in a heterozygous individual demonstrating very low diazoxonase/paraoxonase activity.<sup>18</sup> Additional evidence is derived from the presence of a homozygous *PON2* p.C42Y mutation within FALS descendent from unaffected first cousins. The prediction that progeny of first cousins are homozygous for consanguineous alleles at only ~3.1% of the genome further suggests that this variant is pathogenic. Moreover, three variants were observed in unrelated ALS cases, consistent with the view that they are disease-related; the *PON3* p.D230N mutation was identified in two unrelated cases of FALS and one of SALS, and both *PON1* p.L90P and *PON3* p.D121N mutations were observed in one case each of FALS and SALS. Lastly, none of these variants were detected in >1,100 controls.

Although in our view these observations suggest that the identified FALS-associated *PON* variants are disease-causing mutations, with the evidence in hand we cannot formally exclude the possibility that they represent risk factors, especially because segregation could be proven only in a small pedigree. Moreover, if the penetrance of a disease-causing mutation is incomplete, as happens in many FALS pedigrees, it is difficult to distinguish between a causative mutation with low penetrance and a risk factor. One criterion suggesting that a rare variant influences inherited susceptibility is that it is over- (or under-) represented in disease versus control cohorts; this is underscored if a similar disease association exists for a group of variants affecting the same gene or set of genes with related functions.<sup>19</sup> We observed a statistically significant difference between FALS and controls whether we considered variants in *PON1* only (13/260 versus 8/1,159; p-value < 0.0001; 2-tailed Fisher's exact test), *PON3* only (5/260 versus 3/1,159; p-value 0.0069), or all the rare variants identified in the *PON* cluster (20/260 versus 15/1,159; p-value < 0.0001). We also observed a statistically significant difference between FALS versus SALS whether we considered variants in *PON1* (p-value 0.0007), *PON3* (p-value 0.0064), or all rare variants (p-value < 0.0001), again suggesting that mutations in the *PON* genes contribute more significantly to FALS than SALS.

There are several reports of an association between SALS and the *PON* cluster,<sup>8-13</sup> yet genome-wide association studies (GWAS) and a recent meta-analysis of all published

data<sup>14</sup> failed to detect an association between SNPs in the *PON* locus and susceptibility to SALS. We believe this discrepancy reflects at least two factors. First, there is almost certainly heterogeneity among the different populations combined in the meta-analysis; if the ALS-associated variants differ in the different populations, the ALS associations will not be detected in an aggregate meta-analysis. Second, case-control genome-wide SNP studies are intended to identify common variants, on the assumption that the risk of complex disorders is influenced by common, weakly associated alleles.<sup>19</sup> GWAS depend on the linkage disequilibrium of such common, deleterious variants to a common, linked polymorphic marker, which produces a differential allele frequency between cases and controls and will not detect rare deleterious variants or those common variants that lack linkage disequilibrium to a common marker. As an alternative, the identification of rare deleterious variants requires the sequencing of a candidate gene(s) in a large disease population and then testing the frequency of each in a case-control population.<sup>19</sup> This approach has been taken successfully for variants influencing colorectal adenomas<sup>20,21</sup> and HDL cholesterol levels.<sup>22</sup> Here, we have taken the same approach and identified the *PON* genes as contributors to ALS.

Given the multiplicity of PON substrates, it is difficult to ascertain which altered functions of the mutant *PON* genes are significant in ALS pathogenesis. Because there are ALS-related mutations in all three enzymes, the pathogenic mechanism is likely to reflect some property shared by mutant PON<sub>1</sub>, PON<sub>2</sub>, and PON<sub>3</sub> proteins. Although this might be the loss of some shared function (e.g., anti-oxidative capacity), we cannot exclude the possibility that the mutants have acquired a novel, toxic function. Because in ALS, motor neurons are exposed to abnormal oxidative stresses such as lipoperoxidation,<sup>23</sup> and signs of endoplasmic reticulum stress are increased in the spinal cord of SALS patients,<sup>24</sup> it is plausible that loss of anti-oxidative capacity of the paraoxonases could be neurotoxic. Alternatively, the *PON* mutations might contribute to the development of ALS by impairing metabolism of organophosphorus (OP) or other unknown exogenous toxins. This premise is supported by the recent discovery that mutations in the neuropathy target esterase, a gene coding for a protein targeted by OP in OP-induced delayed neuropathy, can cause motor neuron disease.<sup>25</sup> Understanding how these mutant forms of PON contribute to neurodegeneration will aid in the development of novel therapeutic strategies to attenuate motor neuron cell death in ALS.

## Acknowledgements

This study was supported by the ALS Therapy Alliance, Project ALS, the Angel Fund, the Pierre L. de Bourgnknecht ALS Research Foundation, the Al-Athel ALS Research Foundation, the ALS Family Charitable Foundation, the Packard Center for ALS Research (J.D.G.), American Academy of Neurology Foundation/ALS Association (A.-M.W.), the National Institute of Neurological Disorders and Stroke (IRO1NS050557-03 to R.H.B.), the NIH National Institute of Environmental Health Sciences (RO1ES09883-04A2 to C.E.F.), the Italian Ministry of Health (Malattie Neurodegenerative, ex Art.56, n.533F/N1, N.T., V.S., A.R.), the Peviani family (N.T., V.S.), and the Italian Ministry of Health (grant RF2007/INN644440, F.T., C.G.).

P.S. is supported through the auspices of H. Robert Horvitz, an Investigator of the Howard Hughes Medical Institute in the Department of Biology, Massachusetts Institute of Technology, Cambridge, MA.

## References

- (1) Costa LG, Vitalone A, Cole TB, Furlong CE. Modulation of paraoxonase (PON1) activity. *Biochem Pharmacol* 2005;69:541-550.
- (2) Sorenson RC, Bisgaier CL, Aviram M, Hsu C, Billecke S, La Du BN. Human serum Paraoxonase/ Arylesterase's retained hydrophobic N-terminal leader sequence associates with HDLs by binding phospholipids : apolipoprotein A-I stabilizes activity. *Arterioscler Thromb Vasc Biol* 1999;19:2214-2225.
- (3) Blatter MC, James RW, Messmer S, Barja F, Pometta D. Identification of a distinct human high-density lipoprotein subspecies defined by a lipoprotein-associated protein, K-45. Identity of K-45 with paraoxonase. *Eur J Biochem* 1993;211:871-879.
- (4) Draganov DI, Stetson PL, Watson CE, Billecke SS, La Du BN. Rabbit serum paraoxonase 3 (PON3) is a high density lipoprotein-associated lactonase and protects low density lipoprotein against oxidation. *J Biol Chem* 2000;275:33435-33442.
- (5) Ng CJ, Wadleigh DJ, Gangopadhyay A et al. Paraoxonase-2 is a ubiquitously expressed protein with antioxidant properties and is capable of preventing cell-mediated oxidative modification of low density lipoprotein. *J Biol Chem* 2001;276:44444-44449.
- (6) Mackness MI, Arrol S, Durrington PN. Paraoxonase prevents accumulation of lipoperoxides in low-density lipoprotein. *FEBS Lett* 1991;286:152-154.
- (7) Draganov DI, Teiber JF, Speelman A, Osawa Y, Sunahara R, La Du BN. Human paraoxonases (PON1, PON2, and PON3) are lactonases with overlapping and distinct substrate specificities. *J Lipid Res* 2005;46:1239-1247.

- (8) Landers JE, Shi L, Cho TJ et al. A common haplotype within the PON1 promoter region is associated with sporadic ALS. *Amyotroph Lateral Scler* 2008;9:306-314.
- (9) Saeed M, Siddique N, Hung WY et al. Paraoxonase cluster polymorphisms are associated with sporadic ALS. *Neurology* 2006;67:771-776.
- (10) Slowik A, Tomik B, Wolkow PP et al. Paraoxonase gene polymorphisms and sporadic ALS. *Neurology* 2006;67:766-770.
- (11) Cronin S, Greenway MJ, Prehn JH, Hardiman O. Paraoxonase promoter and intronic variants modify risk of sporadic amyotrophic lateral sclerosis. *J Neural Neurosurg Psychiatry* 2007;78:984-986.
- (12) Morahan JM, Yu B, Trent RJ, Pamphlett R. A gene-environment study of the paraoxonase 1 gene and pesticides in amyotrophic lateral sclerosis. *Neurotoxicology* 2007;28:532-540.
- (13) Valdmanis PN, Kabashi E, Dyck A et al. Association of paraoxonase gene cluster polymorphisms with ALS in France, Quebec, and Sweden. *Neurology* 2008;71:514-520.
- (14) Willis AM, Cronin S, Slowik A et al. A large-scale international meta-analysis of paraoxonase gene polymorphisms in sporadic ALS. *Neurology* 2009;73:16-24.
- (15) Josse D, Xie W, Renault F et al. Identification of residues essential for human paraoxonase (PON1) arylesterase/organophosphatase activities. *Biochemistry* 1999;38:2816-2825.
- (16) Josse D, Ebel C, Stroebel D et al. Oligomeric states of the detergent-solubilized human serum paraoxonase (PON1). *J Biol Chem* 2002;277:33386-33397.
- (17) Grimsley JK, Scholtz JM, Pace CN, Wild JR. Organophosphorus hydrolase is a remarkably stable enzyme that unfolds through a homodimeric intermediate. *Biochemistry* 1997;36:14366-14374.
- (18) Jarvik GP, Jampsa R, Richter RJ et al. Novel paraoxonase (PON1) nonsense and missense mutations predicted by functional genomic assay of PON1 status. *Pharmacogenetics* 2003;13:291-295.
- (19) Bodmer W, Bonilla C. Common and rare variants in multifactorial susceptibility to common diseases. *Nat Genet* 2008;40:695-701.
- (20) Fearnhead NS, Wilding JL, Winney B et al. Multiple rare variants in different genes account for multifactorial inherited susceptibility to colorectal adenomas. *Proc Natl Acad Sci USA* 2004;101:15992-15997.
- (21) Fearnhead NS, Winney B, Bodmer WF. Rare variant hypothesis for multifactorial inheritance: susceptibility to colorectal adenomas as a model. *Cell Cycle* 2005;4:521-525.
- (22) Cohen JC, Kiss RS, Pertsemlidis A, Marcel YL, McPherson R, Hobbs HH. Multiple rare alleles contribute to low plasma levels of HDL cholesterol. *Science* 2004;305:869-872.
- (23) Shibata N, Nagai R, Uchida K et al. Morphological evidence for lipid peroxidation and protein glycooxidation in spinal cords from sporadic amyotrophic lateral sclerosis patients. *Brain Res* 2001;917:97-104.
- (24) Ilieva EV, Ayala V, Jove M et al. Oxidative and endoplasmic reticulum stress interplay in sporadic amyotrophic lateral sclerosis. *Brain* 2007;130:3111-3123.
- (25) Rainier S, Bui M, Mark E et al. Neuropathy target esterase gene mutations cause motor neuron disease. *Am J Hum Genet* 2008;82:780-785.

## SUPPLEMENT

### Supplementary Materials and methods

#### DNA sequencing

Primers were designed for all nine coding exons of each *PON* gene using the software application ExonPrimer, as available through the UCSC Genome Browser (<http://genome.ucsc.edu/>) and tailed with M13 forward and reverse primer sequences. The position of the primers was selected to sequence the entire coding region and at least fifty base pairs beyond the intron-exon boundaries. PCR amplification for DNA sequencing was performed using AmpliTaq Gold 2X PCR Mix (Applied Biosystems) in 30  $\mu$ L reactions containing 37.5 ng of template DNA and 75 nmol of each primer. All reactions were subjected to thermocycling with an initial denaturation at 95°C for five minutes, followed by forty cycles with annealing temperature starting at 65°C and decreasing 0.5°C per cycle, and ten cycles with annealing temperature at 50°C. PCR primer sequences are reported in Supplementary Table 2.1. Successful PCR reactions were confirmed by agarose gel electrophoresis on an Egel-96 device (Invitrogen). PCR reactions were purified by Exonuclease I (NEB) and Shrimp Alkaline Phosphatase (USB) digestion and bi-directionally sequenced using M13 forward and reverse primers. Sequence traces were analyzed for quality using the Phred software package and visual inspection, and failed reactions were repeated. Sequence traces were then aligned to a reference sequence using the Phrap and Consed software packages. Polymorphisms were identified by using the program PolyPhred and visually confirmed.

#### SNP genotyping

Primers and probes for the assay were designed using the software application FileBuilder (Applied Biosystems). Assays were performed in 384-well format with 5  $\mu$ L reactions containing 5 ng template DNA (genomic or whole genome amplified DNA), 1X TaqMan Custom SNP Assay Probes, 1X TaqMan Universal PCR Master Mix, and No AmpErase UNG (Applied Biosystems). All reactions were subjected to thermocycling with an initial denaturation at 95°C for ten minutes, followed by fifty cycles of 95°C for fifteen seconds and 60°C for one minute. Positive controls (sample DNA containing the mutant genotype) were included in triplicate within each assay. An ABI 7900HT instrument was used to measure fluorescence and genotypes were determined using SDS 2.0 software (Applied Biosystems). Primer and probe sequences are reported in Supplementary Table 2.2. All samples displaying the mutant genotype were confirmed by bi-directional DNA sequencing.

Supplementary Table 2.1 PCR primer sequences

| Primer name | Sequence  |
|-------------|---|
| PON1ex1F_2  | 5'-AGTAAACGACGGCCAGTCCCATCGATCCCTTTGTCTA-3'         |
| PON1ex1R    | 5'-GCAGGAAACAGCTATGACCGTTAACAGCCTGGACCCAAC-3'       |
| PON1ex2F    | 5'-AGTAAACGACGGCCAGTTTGTGGACTGCCTACCTTTG-3'         |
| PON1ex2R    | 5'-GCAGGAAACAGCTATGACCTTTGGACAGAATTGAACAGGC-3'      |
| PON1ex3F    | 5'-AGTAAACGACGGCCAGTAAATGGATCCACATCCTGC-3'          |
| PON1ex3R    | 5'-GCAGGAAACAGCTATGACCTGAAAGACTTAAACTGCCAGTCC-3'    |
| PON1ex4F    | 5'-AGTAAACGACGGCCAGTTGTGGTTTGGAGCAGTCAAC-3'         |
| PON1ex4R    | 5'-GCAGGAAACAGCTATGACCGAGGGTAAGTTTAAACCCAGAG-3'     |
| PON1ex5F    | 5'-AGTAAACGACGGCCAGTGGGCTGACAGTGAGAGCTTA-3'         |
| PON1ex5R    | 5'-GCAGGAAACAGCTATGACCAAGTGGATTAATATCCGCTACAG-3'    |
| PON1ex6F    | 5'-AGTAAACGACGGCCAGTAAAGGATTGTATCGGCAGGAC-3'        |
| PON1ex6R    | 5'-GCAGGAAACAGCTATGACCTTTGATTTGATAAATTTACCCC-3'     |
| PON1ex7F    | 5'-AGTAAACGACGGCCAGTTTCTTAAAGCAAAGTTCTTCCC-3'       |
| PON1ex7R    | 5'-GCAGGAAACAGCTATGACCACCCCAATTAAGCAG-3'            |
| PON1ex8F    | 5'-AGTAAACGACGGCCAGTATTGAAATGGGGCAGAATTG-3'         |
| PON1ex8R    | 5'-GCAGGAAACAGCTATGACCATGGTGTGAACCCGGGAG-3'         |
| PON1ex9_1F  | 5'-AGTAAACGACGGCCAGTGCTTCTTATGGAGGATGACCC-3'        |
| PON1ex9_1R  | 5'-GCAGGAAACAGCTATGACCCTGAACAAGACATGGCAAGG-3'       |
| PON2e1R_2   | 5'-GCAGGAAACAGCTATGACCGCGGGAGTCCACACTAC-3'          |
| PON2ex1F_2  | 5'-AGTAAACGACGGCCAGTCCGAAGGTATCTGGGGAAAT-3'         |
| PON2ex2F    | 5'-AGTAAACGACGGCCAGTTGCTGTAAGCCTTTTAAACCC-3'        |
| PON2ex2R    | 5'-GCAGGAAACAGCTATGACCTGATTTATCCACTGAAAAGCAG-3'     |
| PON2ex3F    | 5'-AGTAAACGACGGCCAGTAGAGTCCCAGTTATGCTCTGTG-3'       |
| PON2ex3R    | 5'-GCAGGAAACAGCTATGACCTTTTAAAGCAACTTACTGTTCTGC-3'   |
| PON2ex4F    | 5'-AGTAAACGACGGCCAGTGGCTTTATGCCACTACTTTAACCC-3'     |
| PON2ex4R    | 5'-GCAGGAAACAGCTATGACCTTGAATGAAGAATACAGAAATCACTC-3' |
| PON2ex5F    | 5'-AGTAAACGACGGCCAGTTTAAATGTCAGTGCCTGCC-3'          |
| PON2ex5R    | 5'-GCAGGAAACAGCTATGACCAGATGACAGGACAACCCACC-3'       |
| PON2ex6F    | 5'-AGTAAACGACGGCCAGTTTAAAGCACATGTTGCATAAATC-3'      |
| PON2ex6R    | 5'-GCAGGAAACAGCTATGACCACATTGACAAAGAAAAGCAAAG-3'     |
| PON2ex7F    | 5'-AGTAAACGACGGCCAGTAGGGCCCATGATTGATTAAC-3'         |
| PON2ex7R    | 5'-GCAGGAAACAGCTATGACCAGAATAGCTACTGGCATCC-3'        |
| PON2ex8F    | 5'-AGTAAACGACGGCCAGTGGGCGATGTGTAATTTCTC-3'          |
| PON2ex8R    | 5'-GCAGGAAACAGCTATGACCATAAATACTAAACAAATCATCCCTG-3'  |
| PON2ex9F    | 5'-AGTAAACGACGGCCAGTGTCAATTGTGAAAAACAGGGC-3'        |
| PON2ex9R    | 5'-GCAGGAAACAGCTATGACCTTGTCTGGTTAAATCCCTCAG-3'      |
| PON3ex1F    | 5'-AGTAAACGACGGCCAGTCAATCCGTACGCGAGGC-3'            |
| PON3ex1R    | 5'-GCAGGAAACAGCTATGACCGCAGCCCCTGACCTCAC-3'          |
| PON3ex2F    | 5'-AGTAAACGACGGCCAGTCAAGGATGATTGAAGTCCAC-3'         |
| PON3ex2R    | 5'-GCAGGAAACAGCTATGACCAATGAGCTGGTAGGGCTCAG-3'       |
| PON3ex3F_2  | 5'-AGTAAACGACGGCCAGTCTCAGGATATGCCCTGGAAA-3'         |
| PON3ex3R_2  | 5'-GCAGGAAACAGCTATGACCATGAGAGCAGCATGGAAAA-3'        |
| PON3ex4F    | 5'-AGTAAACGACGGCCAGTTCAGATCATGGAAACAGCTGAC-3'       |
| PON3ex4R    | 5'-GCAGGAAACAGCTATGACCCTGTTACATAAATATTGAGGGGC-3'    |
| PON3ex5F    | 5'-AGTAAACGACGGCCAGTACCTATCATGTAGACTGTGAGGG-3'      |
| PON3ex5R    | 5'-GCAGGAAACAGCTATGACCTTTAAGAAAGCCTGCTGAACC-3'      |
| PON3ex6F    | 5'-AGTAAACGACGGCCAGTTTTTCAAATTGATGAACGTATTAGTC-3'   |
| PON3ex6R    | 5'-GCAGGAAACAGCTATGACCAACTTCTCGTAAGGAAAGGAG-3'      |
| PON3ex7F_2  | 5'-AGTAAACGACGGCCAGTTTGCAGTGGTACTTTCAAGGAG-3'       |
| PON3ex7R_2  | 5'-GCAGGAAACAGCTATGACCAGGGGGCTTTGCTCTGTAT-3'        |
| PON3ex8R_2  | 5'-GCAGGAAACAGCTATGACCTTCTTCCAAGTCAACCCAAC-3'       |
| PON3ex8F_2  | 5'-AGTAAACGACGGCCAGTCCCCTTGAATGAGGAAAACA-3'         |
| PON3ex9F    | 5'-AGTAAACGACGGCCAGTTCCTAGAATGTTTGGGAAGGAC-3'       |
| PON3ex9R    | 5'-GCAGGAAACAGCTATGACCAAAAGCCACACTCACTGGTTG-3'      |

**Supplementary Table 2.2** Taqman assay probe and primers sequences

| Gene        | Mutation   | Forward primer                 | Reverse primer               | Reporter 1                      | Reporter 2                    |
|-------------|------------|--------------------------------|------------------------------|---------------------------------|-------------------------------|
| <i>POM1</i> | p.N19D     | TGATTGGCTGACCCTCTTG            | CCTGACCACAACCCCAACTACTG      | VIC-CTTCTCAGGAACACC-NFQ         | FAM-CTTCTCAGGGACCACC-NFQ      |
| <i>POM1</i> | Intron1+3  | CTGGCACTCTTCAGGAACCA           | TGCAGCCCTCACACAAC            | VIC-CTTCTTACCAGTAAGTTGG-NFQ     | FAM-CTTCTTACCAGTCAGTTGG-NFQ   |
| <i>POM1</i> | p.C42R     | ACTTAATGCTCTCCGAGAGGTACA       | AGACCCTTCTCTCTCACATACAT      | VIC-AGAACTTCTAACTGTAAATTT-NFQ   | FAM-ACTTCTTAAACCGTAATTT-NFQ   |
| <i>POM1</i> | p.L90P     | AACCCCAACAGTCTGGAAAA           | TGATCCCCAATTCACACACTGTT      | VIC-TCTGATGGACCTGAATGA-NFQ      | FAM-TGATGGACCCCGAATGA-NFQ     |
| <i>POM1</i> | p.M127I    | TGACAGTGAGAGCTTAGTTAATGTTTCATT | ACTTGGCATCTGGATGGTTCAC       | VIC-CAGATAATGCCATGTACCTC-NFQ    | FAM-CAGATAATGCCATTTACCTC-NFQ  |
| <i>POM1</i> | p.M127R    | TGACAGTGAGAGCTTAGTTAATGTTTCATT | ACTTGGCATCTGGATGGTTCAC       | VIC-CAGATAATGCCAGGTACCT-NFQ     | FAM-TCAGATAATGCCAGTACCT-NFQ   |
| <i>POM1</i> | p.A20IV    | CCCTACTTACAATCTCTGGGAGATGT     | CCACTCGAACTTCACTGGACTAT      | VIC-AGACCALCGCTAAAAC-NFQ        | FAM-AGGACCACACTAAAAC-NFQ      |
| <i>POM1</i> | p.P315T    | AGGTGCTTCGAATCCAGAACATT        | CTGTGCCATTTCTGCATAAACCT      | VIC-TGTCACTTTAGTTC-NFQ          | FAM-TGTCACTTTAGTTC-NFQ        |
| <i>POM2</i> | p.C42Y     | GAAATCGACTTAAAGCCTCCAGAGA      | GTGCCCAACAAGCATTTTCATATACA   | VIC-CCTTCCACACTGCCACCT-NFQ      | FAM-CCTTCCACACTGCCACCT-NFQ    |
| <i>POM2</i> | p.R96GfsX5 | AGCCTGGAGGAATACTAATGATGGA      | GCCAAATCAAAACCCACAGACTGA     | VIC-CGTGCCCTTGGTTTT-NFQ         | FAM-CGTGCCCTTGGTTTT-NFQ       |
| <i>POM3</i> | p.D121N    | AGAAATCAGTGTGGATTTGACAAAGA     | CTCAITTCCTTATCCCTAAACA       | VIC-ATCAGTATTTTCATCGACAAAAG-NFQ | FAM-CAGTATTTTCATCGACAAAAG-NFQ |
| <i>POM3</i> | p.D230N    | GGATTTTGTAGTCCCAATGGGATCA      | GAAAATGTAAAGGGCAAAAGGATAGAAA | VIC-CAGTCTCAGCAGACAGANFQ        | FAM-AGTCTCAGCAAAACAGANFQ      |



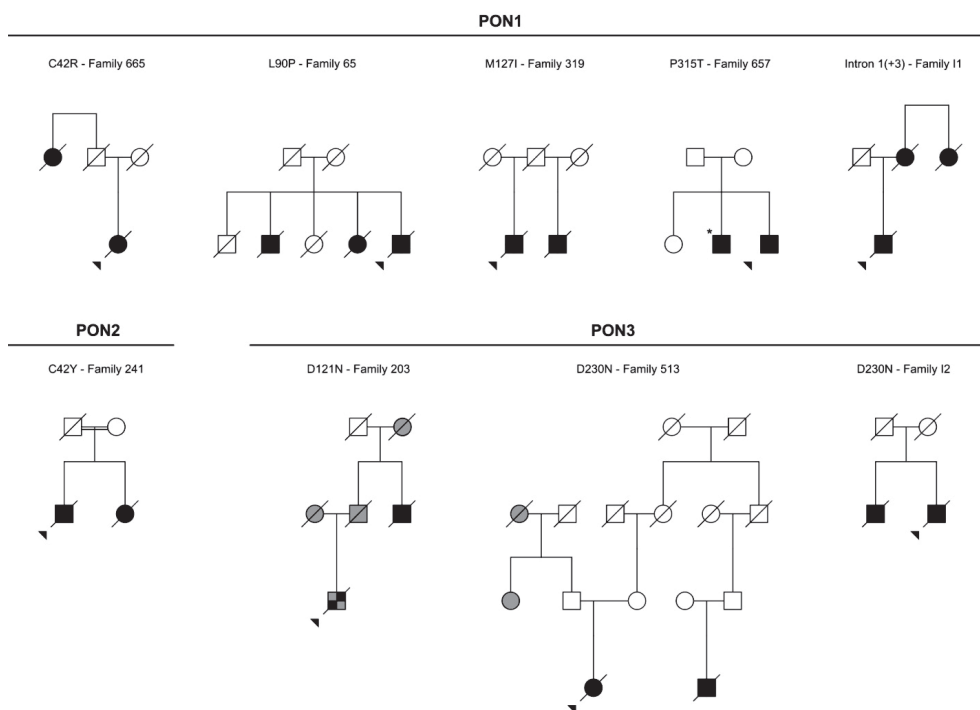
**Supplementary Table 2.3** Clinical description of ALS samples containing *PON* mutations

| Mutation   | Gene        | Exon | Sample ID | Gender | Diagnosis | Ethnicity       | Age at onset (y) | Site of onset | Survival (m) |
|------------|-------------|------|-----------|--------|-----------|-----------------|------------------|---------------|--------------|
| Intron 1+3 | <i>PON1</i> | 1    | 25        | M      | FALS      | Italian         | 50               | LE            | 95           |
| p.C42R     | <i>PON1</i> | 2    | RB11584   | F      | FALS      | Russian         | 65               | UE            | 21           |
| p.L90P     | <i>PON1</i> | 4    | RB12422   | M      | FALS      | German          | 61               | B/Resp.       | 28           |
| p.L90P     | <i>PON1</i> | 4    | RB8734    | M      | SALS      | Caucasian       | 52               | UE            | N/A          |
| p.M127I    | <i>PON1</i> | 5    | RB5275    | M      | FALS      | Chinese         | 70               | UE            | 24           |
| p.P315T    | <i>PON1</i> | 9    | RB10267   | M      | FALS      | Hispanic        | 16               | N/A           | Alive        |
| p.C42Y     | <i>PON2</i> | 2    | RB841     | M      | FALS      | Caucasian       | 60               | N/A           | <24          |
| p.D121N    | <i>PON3</i> | 4    | RB856     | M      | FALS      | English/Italian | 52               | LE            | 25           |
| p.D121N    | <i>PON3</i> | 4    | RB4989    | M      | SALS      | Italian         | 48               | LE            | 31           |
| p.D230N    | <i>PON3</i> | 6    | RB3336    | F      | FALS      | Polish          | 55               | LE            | 7            |
| p.D230N    | <i>PON3</i> | 6    | 124       | M      | FALS      | Italian         | 58               | UE            | N/A          |
| p.D230N    | <i>PON3</i> | 6    | RB10626   | F      | SALS      | Caucasian       | 47               | LE            | N/A          |

Abbreviations: M = male, F = female, FALS = familial amyotrophic lateral sclerosis, SALS = sporadic amyotrophic lateral sclerosis, y = years, UE = upper extremity muscles, LE = lower extremity muscles, B/Resp = bulbar and respiratory muscles, N/A = not available, and m = months.

| Variant   | PON1    |         |         |
|-----------|---------|---------|---------|
|           | N19D    | M127R   | A201V   |
| Human     | ---D--- | ---R--- | ---V--- |
| Chimp     | LFRNHQS | DNAMYLL | LGLAWSY |
| Rhesus    | LFRNHQS | DNAMYLL | LGLAWSY |
| Mouse     | LFRNHQS | DNAMYLL | LGLAWSY |
| Rat       | LYKNHRS | DNTVYLL | LGLPWSN |
| Rabbit    | LFRNHRS | DNTVYLL | LGLPWSN |
| Dog       | LFDGQKS | DNIVYLM | LGLAWSF |
| Cow       | LFRDHRA | DNTVYLL | LGLAWSY |
| Armadillo | FFRDYRS | DNTVYLL | LGLAWSN |
| Zebrafish | VFRDRRS | DNTVYLL | LGLAWSY |
|           | -----   | DGATYLF | FSLEPWC |

**Supplementary Figure 2.1** Evolutionary conservation of *PON1* variants found in ALS and controls. This illustrates the evolutionary conservation of the amino acids implicated by the three variants identified in both cases and controls. For each, the variant residue is shown in red. See Appendix page 378 for Supplementary Figure 2.1 in color.



**Supplementary Figure 2.2** Pedigrees of familial ALS cases harboring *PON* mutations. The pedigree structure for all eight familial ALS cases with *PON* mutations is shown. Affected individuals are shown in black. Unaffected individuals are shown in white. Individuals with dementia are shown in grey and individual with ALS and dementia are shown by a checkerboard pattern. Arrows indicate the individual identified harboring the mutation. For Family 657, genotyping revealed an affected sibling (indicated by the asterisk) also harboring the p.P315T mutation. DNA was not available from any other affected member of the remaining families.

# 2

# 3

**“The harm is to persist in one’s own self-deception and ignorance.”**

Marcus Aurelius, Meditations.

# Rare and common paraoxonase gene variants in amyotrophic lateral sclerosis patients

Marka van Blitterswijk, Anna Blokhuis, Michael A. van Es, Paul W.J. van Vught, Paulina A. Rowicka, Helenius J. Schelhaas, Anneke J. van der Kooi, Marianne de Visser, Jan H. Veldink\*, Leonard H. van den Berg\*

\* Contributed equally to this work.

## Abstract

Common variants in the paraoxonase family (*PON*) have been reported in population-specific cohorts of patients with amyotrophic lateral sclerosis (ALS), but a recent meta-analysis did not show a clear association. Recently, rare *PON* mutations have also been identified in ~0.3% of the sporadic ALS (SALS) cases, and ~2.5% of the familial ALS (FALS) cases. In this study, we assessed the frequency of rare and common *PON* variants in 1,118 patients with SALS, 93 patients with FALS, and 1,240 control subjects of Dutch descent. We identified *PON* mutations in 1.4% of SALS patients, 2.1% of FALS patients, and 2.5% of control subjects. A variable-threshold test was performed, and did not reveal significant differences in mutational burden between patients and control subjects. A total of 21 single nucleotide polymorphisms (SNPs) in *PON* were also investigated, and no significant differences in allele frequencies were present between patients and control subjects. Thus, this study does not support the premise that rare mutations or common variations in *PON* contribute to ALS susceptibility.

## Introduction

The paraoxonase (PON) family contains three members (*PON1*, *PON2*, and *PON3*), which are located on chromosome seven.<sup>1</sup> Their genes are approximately seventy percent similar and most likely derived from a common precursor.<sup>2</sup> *PON1* was identified due to its ability to hydrolyze organophosphates and pesticides, including paraoxon;<sup>3,4</sup> *PON2* and *PON3* lack this ability; they are lactonases/lactonizing enzymes.<sup>5,7</sup>

It has been shown that polymorphisms in *PON1* influence the quantity and quality of *PON1*, thereby affecting the efficiency of organophosphates detoxification.<sup>8</sup> Since exposure to solvents or chemicals may be associated with amyotrophic lateral sclerosis (ALS),<sup>9</sup> *PON* polymorphisms have been studied in ALS patients. To date, six studies have reported an association between genetic variants in the *PON* gene cluster and ALS.<sup>10-15</sup>

Nonetheless, a meta-analysis, which included genome-wide association studies (GWAS), could not detect a clear association between single nucleotide polymorphisms (SNPs) in *PON* and ALS, when taking the burden of multiple testing into account.<sup>16</sup> This could indicate that rare deleterious variants in *PON* are involved in the pathogenesis of ALS.<sup>17</sup> A recent study investigated this hypothesis, and detected mutations that were predicted to alter *PON*'s function in ALS patients (Supplementary Table 3.1),<sup>17</sup> however, only a relatively small number of control subjects were screened for *PON* mutations.

Thus, to clarify the role of *PON* variants in ALS, we decided to investigate the frequency of rare and common *PON* variants in a large cohort of 1,211 ALS patients and 1,240 control subjects of Dutch descent.

## Methods

### Cases

At national referral centers for neuromuscular diseases (University Medical Center Utrecht, Academic Medical Center Amsterdam, and Radboud University Nijmegen Medical Center), we obtained DNA of 1,118 SALS patients and 93 FALS patients from 80 different families. These patients were diagnosed with ALS according to the El Escorial Criteria;<sup>18,19</sup> baseline characteristics are shown in Table 3.1. FALS patients had already been screened for mutations in superoxide dismutase-1 (*SOD1*), angiogenin (*ANG*), fused in sarcoma / translated in liposarcoma (*FUS/TLS*), TAR DNA-binding protein (*TARDBP*), vesicle-associated membrane protein B (*VAPB*), multivesicular body

**Table 3.1** Baseline characteristics of study population

| Group            | Number (n)   | Male/female (n) (%)                   | Age at onset (y) (CI)             | Spinal/bulbar (n) (%)            | Alive/deceased (n) (%)           | Duration (y) (CI)              |
|------------------|--------------|---------------------------------------|-----------------------------------|----------------------------------|----------------------------------|--------------------------------|
| SALS             | 1,118        | 672/446<br>(60/40)**                  | 60.5<br>(59.8-61.2)               | 651/354<br>(65/35)*              | 177/919<br>(16/84)               | 3.8<br>(3.6-4.1)               |
| FALS             | 93           | 48/45<br>(52/48)                      | 59.1<br>(56.8-61.4)               | 73/20<br>(78/22)*                | 21/72<br>(23/77)                 | 3.9<br>(3.2-4.5)               |
| <b>Total ALS</b> | <b>1,211</b> | <b>720/491</b><br><b>(59/41)***</b>   | <b>60.4</b><br><b>(59.7-61.0)</b> | <b>724/374</b><br><b>(66/33)</b> | <b>198/991</b><br><b>(17/83)</b> | <b>3.8</b><br><b>(3.6-4.1)</b> |
| <b>CON</b>       | <b>1,240</b> | <b>643/595</b><br><b>(52/48)*****</b> |                                   |                                  |                                  |                                |

Abbreviations: SALS = sporadic amyotrophic lateral sclerosis (ALS), FALS = familial ALS, CON = control subjects, n = number, y = years, and CI = 95% confidence interval. \* P-value 0.0082, \*\* p-value < 0.0001, \*\*\* p-value 0.0002.

protein 2B (*CHMP2B*), optineurin (*OPTN*),<sup>20</sup> valosin-containing protein (*VCP*)<sup>21</sup> and chromosome 9 open reading frame 72 (*C9orf72*). Furthermore, 1,240 control subjects of Dutch descent were screened for variants in *PON*. For rs662 (*PON1* exon six), a total of 1,498 SALS patients and 2,375 control subjects were tested. We also investigated Dutch GWAS data of 584 ALS patients and 7,238 control subjects for common variants in *PON*, as described previously;<sup>22</sup> we excluded samples already described in the *PON* meta-analysis.<sup>16</sup> All material was obtained with approval of the Institutional Review Board, and all participants gave informed consent.

### Genetic analysis

We screened ALS patients and control subjects for mutations in *PON1* (NM\_000446) and *PON3* (NM\_000940). Exons and exon-intron boundaries were also screened for SNPs. *PON2* was not included, since previous reports suggested that *PON2* is not involved in ALS pathogenesis.<sup>17</sup> Primers used for amplification by PCR are available upon request. We used BigDye Terminator 3.1 sequencing kit (Applied Biosystems, Foster City, California), DNA Analyzer 3730XL and PolyPhred for sequencing and data analysis.<sup>23</sup> Mutations were confirmed on genomic DNA and the impact of these mutations on the structure and function of *PON1* and *PON3* were predicted using PolyPhen-2 (<http://genetics.bwh.harvard.edu/pph2/>) and PMut (<http://mmb2.pcb.ub.es:8080/PMut/>).



## Statistical analysis

For statistical analysis of baseline characteristics, Fisher's exact test or Chi-square test were used to compare gender, site of onset, and current status (alive / deceased) between groups; a Mann-Whitney test was used to compare age at onset and disease duration (GraphPad Prism version 5, <http://www.graphpad.com>). Disease duration was defined as the interval between age at onset and age at death, or between age at onset and age last known to be alive. P-values below 0.05 were considered significant.

The variable-threshold approach was used to analyze rare variants. This approach groups mutations, and is particularly valuable since it increases statistical power.<sup>24</sup> It uses a threshold that separates mutations that are likely to be detrimental or non-detrimental, based on their minor allele frequencies, applying much higher weights to very rare variants. Statistical significance is assessed by permutation testing with variable thresholds, using 100,000 permutations. Weighted PolyPhen-2 values were also included to incorporate the predicted effects of these mutations. This analysis was performed using statistical analysis program R (CRAN; <http://www.Rproject.org>).

For SNPs encountered in our sequence data, a Chi-square test with Bonferroni correction was used to determine statistical differences in allele frequencies between patients and control subjects. *PON* SNPs that were detected in our GWAS cohort were tested in additive-, dominant- and recessive models, and corrected for gender and population stratification, as described elsewhere.<sup>22</sup>

## Results

### Baseline characteristics

Our cohort of 1,211 ALS patients had an average age at onset of sixty years, disease duration of 3.8 years, and 33% of these patients presented with bulbar symptoms (Table 3.1). These clinical characteristics are in accordance with previous reports.<sup>25</sup>

### Frequencies of rare variants

In our population, we identified mutations in seventeen SALS patients (1.4%), two FALS patients (2.1%), and 34 control subjects (2.5%) (Table 3.2). Five mutations were detected in patients and controls (p.N19D, p.A201V, p.E19X, p.R32X and p.G324D), three mutations were only detected in patients (p.F293del, p.I142V and p.V345I), and six mutations were only detected in control subjects (p.P40L, p.M127R, p.D121N, p.T186S, p.V166M and

**Table 3.2** Genetic variation found in *PON*

| Gene        | Mutation     | Exon | SALS (n = 1,118)      | FALS (n = 93) | ALS (n = 1,211)       | CON (n = 1,240)       | Prediction PMut | Prediction PolyPhen-2 |
|-------------|--------------|------|-----------------------|---------------|-----------------------|-----------------------|-----------------|-----------------------|
| <i>PON1</i> | p.N19D       | 1    | 1 (0.1%)              | 0 (0.0%)      | 1 (0.1%)              | 2 (0.2%)              | Neutral         | Benign                |
|             | p.P40L       | 2    | 0 (0.0%)              | 0 (0.0%)      | 0 (0.0%)              | 1 (0.1%)              | Pathological    | Benign                |
|             | p.M127R      | 5    | 0 (0.0%)              | 0 (0.0%)      | 0 (0.0%)              | 6 (0.5%)              | Pathological    | Benign                |
|             | p.A201V      | 6    | 4 (0.3%) <sup>a</sup> | 0 (0.0%)      | 4 (0.3%) <sup>a</sup> | 7 (0.3%) <sup>a</sup> | Neutral         | Possibly damaging     |
|             | p.F293del    | 8    | 1 (0.1%)              | 0 (0.0%)      | 1 (0.1%)              | 0 (0.0%)              | N/A             | N/A                   |
|             | p.E19X       | 1    | 1 (0.1%)              | 0 (0.0%)      | 1 (0.1%)              | 2 (0.2%)              | N/A             | N/A                   |
|             | p.R32X       | 2    | 3 (0.3%)              | 1 (1.1%)      | 4 (0.3%)              | 5 (0.4%)              | N/A             | N/A                   |
|             | p.D121N      | 4    | 0 (0.0%)              | 0 (0.0%)      | 0 (0.0%)              | 1 (0.1%)              | Neutral         | Possibly damaging     |
| <i>PON3</i> | p.I142V      | 5    | 1 (0.1%)              | 0 (0.0%)      | 1 (0.1%)              | 0 (0.0%)              | Neutral         | Benign                |
|             | p.T186S      | 6    | 0 (0.0%)              | 0 (0.0%)      | 0 (0.0%)              | 1 (0.1%)              | Neutral         | Benign                |
|             | p.V166M      | 6    | 0 (0.0%)              | 0 (0.0%)      | 0 (0.0%)              | 1 (0.1%)              | Neutral         | Possibly damaging     |
|             | p.L258Q      | 7    | 0 (0.0%)              | 0 (0.0%)      | 0 (0.0%)              | 1 (0.1%)              | Pathological    | Benign                |
|             | p.G324D      | 9    | 5 (0.4%)              | 1 (1.1%)      | 6 (0.5%)              | 7 (0.6%)              | Pathological    | Probably damaging     |
|             | p.V345I      | 9    | 1 (0.1%)              | 0 (0.0%)      | 1 (0.1%)              | 0 (0.0%)              | Neutral         | Benign                |
|             | <b>Total</b> |      | 17 (1.4%)             | 2 (2.1%)      | 19 (1.5%)             | 34 (2.5%)             |                 |                       |

Abbreviation: N/A = not applicable. <sup>a</sup> For *PON1* exon six, a total of 1,498 SALS patients and 2,375 control subjects were screened for rare variants.

p.L258Q). With the exception of p.F293del, p.I142V and p.V345I, none of these mutations was more frequently encountered in ALS patients than in control subjects.

We used *in silico* prediction programs to predict the effects of these mutations, and show that most of these mutations are predicted to be benign (Table 3.2). Mutations that are predicted to have damaging effects were (also) present in our control subjects, and therefore, unlikely to be pathogenic. Subsequently, we determined the evolutionary conservation of three mutations that were only detected in ALS patients, and show that their conservation level is moderate (Supplementary Figure 3.1).

The nineteen ALS patients with rare variants in the *PON* gene cluster had an average age at onset of 64 years, disease duration of 3.4 years, and 26% presented with bulbar symptoms (Supplementary Table 3.2), which is comparable to our baseline characteristics and previous reports.<sup>25</sup>

We performed a variable-threshold test that included the fourteen identified mutations, which showed that there is no significant difference in mutational burden between patients and control subjects (p-value 0.92), even when the potential damaging effects of mutations are taken into account (p-value 0.94).

### Frequencies of common variants

While screening for mutations, we encountered twelve SNPs in exons and exon-intron boundaries, and compared their frequencies in SALS patients, FALS patients and control subjects. We did not detect significant deviations of the Hardy-Weinberg equilibrium in our control subjects. In Table 3.3, we demonstrate that there are no significant differences in minor allele frequencies, and thus, none of these SNPs seems to be associated with ALS. In addition, we looked at thirteen *PON* SNPs that were included in our Dutch GWAS data; these included four SNPs that were also present in our sequence data. None of these SNPs was associated with ALS (Supplementary Table 3.3).

## Discussion

In the present paper, we demonstrate that rare variants in *PON1* and *PON3* are present in 1.4% of our SALS patients, 2.1% of our FALS patients, and 2.5% of our control subjects. Moreover, we show that there are no significant differences in allele frequencies of 21 *PON* SNPs between ALS patients and control subjects. Our findings indicate that these *PON* variants are not associated with ALS.

**Table 3.3** Minor allele frequencies of SNPs in *PON*

| Gene        | SNP              | Location   | SALS (n = 1,118)  | FALS (n = 93) | CON (n = 1,240)   |
|-------------|------------------|------------|-------------------|---------------|-------------------|
| <i>PON1</i> | rs854560 (=L55M) | Exon 3     | 0.36              | 0.33          | 0.36              |
|             | rs72552788       | Exon 4     | <0.01             | <0.01         | <0.01             |
|             | rs13306698       | Exon 5     | <0.01             | <0.01         | <0.01             |
|             | rs3917541        | Intron 5-6 | 0.05              | 0.07          | 0.06              |
|             | rs3917594        | Exon 6     | <0.01             | <0.01         | <0.01             |
|             | rs662 (=Q192R)   | Exon 6     | 0.25 <sup>a</sup> | 0.26          | 0.24 <sup>a</sup> |
| <i>PON3</i> | rs17886586       | Intron 1   | 0.01              | 0.01          | 0.01              |
|             | rs13226149       | Exon 1     | 0.25              | 0.23          | 0.27              |
|             | rs11970910       | Intron 1-2 | 0.44              | 0.44          | 0.48              |
|             | rs3735587        | Intron 2-3 | <0.01             | <0.01         | <0.01             |
|             | rs1053275        | Exon 4     | 0.46              | 0.42          | 0.49              |
|             | rs17880470       | Exon 6     | <0.01             | <0.01         | 0.01              |

No significant differences in allele frequencies were detected (Bonferroni correction:  $\alpha/n = 0.05/12 = 0.0042$ ). <sup>a</sup> A total of 1,498 SALS patients and 2,374 control subjects were screened.

Speculations about the effects of *PON* variants on ALS started after reports that military personnel, who were deployed during the Gulf War, had a two-fold increased risk of developing ALS.<sup>26-29</sup> This raised questions about war-related environmental triggers, like exposure to a wide range of biological and chemical agents. Because of *PON1*'s capability to break down nerve toxins, genetic variation in *PON1* was thought to influence the genetic susceptibility to toxic environmental factors.<sup>30</sup> In Gulf War Veterans, paraoxon hydrolysis was found to be fifty percent lower than the hydrolysis in control subjects, and serum *PON1* concentrations were also significantly lower than in control subjects.<sup>31</sup> Exposure to organophosphates was already known to cause several neurological syndromes, including a cholinergic syndrome and intermediate syndrome (weakness of respiratory-, neck- and proximal limb muscles), and a delayed polyneuropathy.<sup>8</sup> All these findings supported a possible link between ALS susceptibility, the Gulf War, and *PON1*. This hypothesis was strengthened by reports that two major *PON* SNPs, p.Q192R (=rs662) and p.L55M (=rs854560),<sup>32</sup> exerted effects on paraoxonase, arylesterase and lactone activity.<sup>33</sup> In addition, individuals with QQ and MM genotypes were shown to be more susceptible for genotoxicity, causing variation in enzyme activities and DNA

damage.<sup>34</sup> Towards this end, it might be interesting to investigate whether environmental exposures in the context of specific *PON* genotypes are related to ALS susceptibility, a possibility we cannot exclude from this study.

Currently, several studies have already reported that common genetic variants in the *PON* gene cluster are associated with ALS; other studies have, however, contradicted these results.<sup>10-15;35</sup> Importantly, a large-scale international meta-analysis of more than four thousand ALS patients, could not detect an association between *PON* and SALS.<sup>16</sup> These negative findings could be due to population-specific differences, which cause a loss of association with certain variants that differ among populations. Therefore, we investigated the frequency of 21 *PON* SNPs in the Dutch population, including p.Q192R and p.L55M. We were unable to detect significant differences, and thus our findings support studies that reported a lack of association between common *PON* variants and ALS. Our findings are also in line with a recent report that described a lack of association between *PON* SNPs and other neurodegenerative diseases, these included Alzheimer's disease (AD), Parkinson's disease (PD), and AD-PD spectrum diseases.<sup>36</sup>

*PON1* was previously sequenced in 188 SALS patient and 260 FALS patients.<sup>17</sup> After additional Taqman analysis of 996 SALS patients and a total of 1,159 control subjects, four heterozygous missense mutations were detected that were not present in a SNP database (dbSNP) or in control subjects (p.C42R, p.L90P, p.M127I, p.P315T). *PON2* and *PON3* were also sequenced in 166 FALS cases, and after additional Taqman analysis, this resulted in the identification of p.C42Y, p.D121N and p.D230N (Supplementary Table 3.1). Whereas these mutations could represent benign variants as opposed to causal mutations, we screened a large cohort of ALS patients and control subjects of Dutch descent. We identified novel missense mutations, three of which were only detected in ALS patients (p.F293del, p.I142V and p.V345I). It is important to note, however, that we detected the p.D121N mutation (*PON3*) that was previously reported in ALS patients, in one control subject. We also identified novel missense mutations in control subjects, and showed that most of the identified mutations were predicted to be benign and/or located in moderately conserved regions. Moreover, we performed a variable-threshold test on grouped mutations and did not detect significant differences between ALS patients and control subjects. Possibly, the previous study underestimated the number of rare variants in control subjects, while a small cohort of control subjects was sequenced and therefore, other rare variants that could have been detected by sequencing a large cohort of control subjects may have been missed. Because we sequenced more than 1,200 ALS patients and control subjects, we were able to extend the number of *PON* mutations reported so far.

To summarize, we have identified rare *PON* variants in 1.5% of our ALS patients and 2.5% of our control subjects. We did not detect significant differences in mutational burden for rare variants, nor did we detect differences in allele frequencies of 21 *PON* SNPs. Hence, our findings in a large population of ALS patients and control subjects of Dutch descent do not support the premise that rare and common variants in *PON* contribute to ALS susceptibility.

## Acknowledgements

This work was supported by the VSB fonds, The Brain Foundation of The Netherlands, Prinses Beatrix Fonds, Catharijne Stichting, H. Kersten and M. Kersten, J. R. van Dijk, and the Adessium Foundation.

## References

- (1) Primo-Parmo SL, Sorenson RC, Teiber J, La Du BN. The human serum paraoxonase/arylesterase gene (*PON1*) is one member of a multigene family. *Genomics* 1996;33:498-507.
- (2) Camps J, Marsillach J, Joven J. The paraoxonases: role in human diseases and methodological difficulties in measurement. *Crit Rev Clin Lab Sci* 2009;46:83-106.
- (3) Aldridge WN. Serum esterases. I. Two types of esterase (A and B) hydrolysing p-nitrophenyl acetate, propionate and butyrate, and a method for their determination. *Biochem J* 1953;53:110-117.
- (4) Aldridge WN. Serum esterases. II. An enzyme hydrolysing diethyl p-nitrophenyl phosphate (E600) and its identity with the A-esterase of mammalian sera. *Biochem J* 1953;53:117-124.
- (5) Billecke S, Draganov D, Counsell R et al. Human serum paraoxonase (*PON1*) isozymes Q and R hydrolyze lactones and cyclic carbonate esters. *Drug Metab Dispos* 2000;28:1335-1342.
- (6) Draganov DI, Teiber JF, Speelman A, Osawa Y, Sunahara R, La Du BN. Human paraoxonases (*PON1*, *PON2*, and *PON3*) are lactonases with overlapping and distinct substrate specificities. *J Lipid Res* 2005;46:1239-1247.
- (7) Precourt LP, Amre D, Denis MC et al. The three-gene paraoxonase family: physiologic roles, actions and regulation. *Atherosclerosis* 2011;214:20-36.
- (8) Costa LG, Cole TB, Furlong CE. Polymorphisms of paraoxonase (*PON1*) and their significance in clinical toxicology of organophosphates. *J Toxicol Clin Toxicol* 2003;41:37-45.
- (9) Mitchell JD. Amyotrophic lateral sclerosis: toxins and environment. *Amyotroph Lateral Scler Other Motor Neuron Disord* 2000;1:235-250.

- (10) Valdmanis PN, Kabashi E, Dyck A et al. Association of paraoxonase gene cluster polymorphisms with ALS in France, Quebec, and Sweden. *Neurology* 2008;71:514-520.
- (11) Cronin S, Greenway MJ, Prehn JH, Hardiman O. Paraoxonase promoter and intronic variants modify risk of sporadic amyotrophic lateral sclerosis. *J Neurol Neurosurg Psychiatry* 2007;78:984-986.
- (12) Morahan JM, Yu B, Trent RJ, Pamphlett R. A gene-environment study of the paraoxonase 1 gene and pesticides in amyotrophic lateral sclerosis. *Neurotoxicology* 2007;28:532-540.
- (13) Slowik A, Tomik B, Wolkow PP et al. Paraoxonase gene polymorphisms and sporadic ALS. *Neurology* 2006;67:766-770.
- (14) Saeed M, Siddique N, Hung WY et al. Paraoxonase cluster polymorphisms are associated with sporadic ALS. *Neurology* 2006;67:771-776.
- (15) Landers JE, Shi L, Cho TJ et al. A common haplotype within the PON1 promoter region is associated with sporadic ALS. *Amyotroph Lateral Scler* 2008;9:306-314.
- (16) Willis AM, Cronin S, Slowik A et al. A large-scale international meta-analysis of paraoxonase gene polymorphisms in sporadic ALS. *Neurology* 2009;73:16-24.
- (17) Ticozzi N, Leclerc AL, Keagle PJ et al. Paraoxonase gene mutations in amyotrophic lateral sclerosis. *Ann Neurol* 2010;68:102-107.
- (18) Brooks BR, Miller RG, Swash M, Munsat TL. El Escorial revisited: revised criteria for the diagnosis of amyotrophic lateral sclerosis. *Amyotroph Lateral Scler Other Motor Neuron Disord* 2000;1:293-299.
- (19) Brooks BR. El Escorial World Federation of Neurology criteria for the diagnosis of amyotrophic lateral sclerosis. Subcommittee on Motor Neuron Diseases/Amyotrophic Lateral Sclerosis of the World Federation of Neurology Research Group on Neuromuscular Diseases and the El Escorial "Clinical limits of amyotrophic lateral sclerosis" workshop contributors. *J Neurol Sci* 1994;124 Suppl:96-107.
- (20) van Blitterswijk M, van Vught PW, van Es MA et al. Novel optineurin mutations in sporadic amyotrophic lateral sclerosis patients. *Neurobiol Aging* 2011 Jul 27.
- (21) Koppers M, van Blitterswijk M, Vlam L et al. VCP mutations in familial and sporadic amyotrophic lateral sclerosis. *Neurobiol Aging* 2011 Nov 9.
- (22) van Es MA, Veldink JH, Saris CG et al. Genome-wide association study identifies 19p13.3 (UNC13A) and 9p21.2 as susceptibility loci for sporadic amyotrophic lateral sclerosis. *Nat Genet* 2009;41:1083-1087.
- (23) Nickerson DA, Tobe VO, Taylor SL. PolyPhred: automating the detection and genotyping of single nucleotide substitutions using fluorescence-based resequencing. *Nucleic Acids Res* 1997;25:2745-2751.
- (24) Price AL, Kryukov GV, de Bakker PI et al. Pooled association tests for rare variants in exon-resequencing studies. *Am J Hum Genet* 2010;86:832-838.
- (25) Huisman MH, de Jong SW, van Doormaal PT et al. Population based epidemiology of amyotrophic lateral sclerosis using capture-recapture methodology. *J Neurol Neurosurg Psychiatry* 2011;82:1165-1170.
- (26) Rose MR. Gulf War service is an uncertain trigger for ALS. *Neurology* 2003;61:730-731.

- (27) Barohn RJ, Rowland LP. Neurology and Gulf War veterans. *Neurology* 2002;59:1484-1485.
- (28) Haley RW. Excess incidence of ALS in young Gulf War veterans. *Neurology* 2003;61:750-756.
- (29) Horner RD, Kamins KG, Feussner JR et al. Occurrence of amyotrophic lateral sclerosis among Gulf War veterans. *Neurology* 2003;61:742-749.
- (30) Greenberg DA, Stewart WC, Rowland LP. Paraoxonase genes and susceptibility to ALS. *Neurology* 2009;73:11-12.
- (31) Mackness B, Durrington PN, Mackness MI. Low paraoxonase in Persian Gulf War Veterans self-reporting Gulf War Syndrome. *Biochem Biophys Res Commun* 2000;276:729-733.
- (32) Adkins S, Gan KN, Mody M, La Du BN. Molecular basis for the polymorphic forms of human serum paraoxonase/arylesterase: glutamine or arginine at position 191, for the respective A or B allozymes. *Am J Hum Genet* 1993;52:598-608.
- (33) Rainwater DL, Rutherford S, Dyer TD et al. Determinants of variation in human serum paraoxonase activity. *Heredity* 2009;102:147-154.
- (34) Singh S, Kumar V, Thakur S et al. Paraoxonase-1 genetic polymorphisms and susceptibility to DNA damage in workers occupationally exposed to organophosphate pesticides. *Toxicol Appl Pharmacol* 2011;252:130-137.
- (35) Ricci C, Battistini S, Cozzi L et al. Lack of association of PON polymorphisms with sporadic ALS in an Italian population. *Neurobiol Aging* 2011;32:522.e7-e13.
- (36) Wingo TS, Rosen A, Cutler DJ, Lah JJ, Levey AI. Paraoxonase-1 polymorphisms in Alzheimer's disease, Parkinson's disease, and AD-PD spectrum diseases. *Neurobiol Aging* 2012;33:204.e13-e15.



# SUPPLEMENT

## Supplementary Tables

**Supplementary Table 3.1** Rare variants in the *PON* gene cluster

| Study                       | Population       | Cases (n)                                  | Controls (n)            | Gene        | Mutation       | FALS (n) (%) | SALS (n) (%)                                  | CON (n) (%)               |             |               |            |               |               |
|-----------------------------|------------------|--|-------------------------|-------------|----------------|--------------|---|---------------------------|-------------|---------------|------------|---------------|---------------|
| Ticozzi et al. <sup>1</sup> | Mainly Caucasian | 260 FALS,<br>188/ 996<br>SALS <sup>a</sup> | 188/ 1,159 <sup>a</sup> | <i>PON1</i> | <b>p.N19D</b>  | 2/260 (0.8)  | 6/1,184 (0.5)                                 | 3/1,159 (0.3)             |             |               |            |               |               |
|                             |                  |  |                         |             | p.C42R         | 1/260 (0.4)  | 0/1,184 (0.0)                                 | 0/1,159 (0.0)             |             |               |            |               |               |
|                             |                  |  |                         |             | p.L90P         | 1/260 (0.4)  | 1/1,184 (0.1)                                 | 0/1,159 (0.0)             |             |               |            |               |               |
|                             |                  |  |                         |             | p.M127I        | 1/260 (0.4)  | 0/1,184 (0.0)                                 | 0/1,159 (0.0)             |             |               |            |               |               |
|                             |                  |  |                         |             | <b>p.M127R</b> | 2/260 (0.8)  | 6/1,184 (0.5)                                 | 2/1,159 (0.2)             |             |               |            |               |               |
|                             |                  |  |                         |             | <b>p.A201V</b> | 4/260 (1.5)  | 3/1,184 (0.3)                                 | 3/1,159 (0.3)             |             |               |            |               |               |
|                             |                  |  |                         |             | p.P315T        | 1/260 (0.4)  | 0/1,184 (0.0)                                 | 0/1,159 (0.0)             |             |               |            |               |               |
|                             |                  |  |                         |             | p.C42Y         | 1/260 (0.4)  | 0/1,184 (0.0)                                 | 0/1,159 (0.0)             |             |               |            |               |               |
|                             |                  |  |                         |             | p.R96GfsX5     | 1/260 (0.4)  | 6/1,184 (0.5)                                 | 4/1,159 (0.3)             |             |               |            |               |               |
|                             |                  |  |                         |             | <b>p.D121N</b> | 1/260 (0.4)  | 1/1,184 (0.1)                                 | 0/1,159 (0.0)             |             |               |            |               |               |
|                             |                  |  |                         |             | p.D230N        | 2/260 (0.8)  | 1/1,184 (0.1)                                 | 0/1,159 (0.0)             |             |               |            |               |               |
|                             |                  |  |                         |             | <b>p.G324D</b> | 2/260 (0.8)  | 1/1,184 (0.1)                                 | 3/1,159 (0.3)             |             |               |            |               |               |
|                             |                  |  |                         |             | This study     | Dutch        | 93 FALS,<br>1,118/ 1,498<br>SALS <sup>b</sup> | 1,240/ 2,375 <sup>b</sup> | <i>PON1</i> | <b>p.N19D</b> | 0/93 (0.0) | 1/1,118 (0.1) | 2/1,240 (0.2) |
|                             |                  |  |                         |             |                |              |   |                           |             | p.P40L        | 0/93 (0.0) | 0/1,118 (0.0) | 1/1,240 (0.1) |
| <b>p.M127R</b>              | 0/93 (0.0)       | 0/1,118 (0.0)                              | 6/1,240 (0.5)           |             |                |              |   |                           |             |               |            |               |               |
| <b>p.A201V</b>              | 0/93 (0.0)       | 4/1,498 (0.3)                              | 7/2,375 (0.3)           |             |                |              |   |                           |             |               |            |               |               |
| p.F293del                   | 0/93 (0.0)       | 1/1,118 (0.1)                              | 0/1,240 (0.0)           |             |                |              |   |                           |             |               |            |               |               |
| p.E19X                      | 0/93 (0.0)       | 1/1,118 (0.1)                              | 2/1,240 (0.2)           |             |                |              |   |                           |             |               |            |               |               |
| p.R32X                      | 1/93 (1.1)       | 3/1,118 (0.3)                              | 5/1,240 (0.4)           |             |                |              |   |                           |             |               |            |               |               |
| <b>p.D121N</b>              | 0/93 (0.0)       | 0/1,118 (0.0)                              | 1/1,240 (0.1)           |             |                |              |   |                           |             |               |            |               |               |
| p.I142V                     | 0/93 (0.0)       | 1/1,118 (0.1)                              | 0/1,240 (0.0)           |             |                |              |   |                           |             |               |            |               |               |
| p.T186S                     | 0/93 (0.0)       | 0/1,118 (0.0)                              | 1/1,240 (0.1)           |             |                |              |   |                           |             |               |            |               |               |
| p.V166M                     | 0/93 (0.0)       | 0/1,118 (0.0)                              | 1/1,240 (0.1)           |             |                |              |   |                           |             |               |            |               |               |
| p.L258Q                     | 0/93 (0.0)       | 0/1,118 (0.0)                              | 1/1,240 (0.1)           |             |                |              |   |                           |             |               |            |               |               |
| <b>p.G324D</b>              | 1/93 (1.1)       | 5/1,118 (0.4)                              | 7/1,240 (0.6)           |             |                |              |   |                           |             |               |            |               |               |

Abbreviations: n = number, FALS = familial amyotrophic lateral sclerosis, SALS = sporadic amyotrophic lateral sclerosis, and CON = control subjects. Mutations that were detected in both studies are denoted by the bold font. <sup>a</sup> A cohort of 188 SALS patients and 188 control subjects were used for direct sequencing, a cohort of 996 SALS patients and 1,159 control subjects were genotyped using custom Taqman SNP Genotyping Assays. <sup>b</sup> For *PON1* exon six a total of 1,498 SALS patients and 2,375 control subjects were screened for rare variants.

**Supplementary Table 3.2** Clinical characteristics of ALS patients identified with *PON* mutations

| Gene        | Mutation | Group    | El Escorial criteria at time of diagnosis | Gender | Age at onset (y) | Site of onset   | Duration (m)    |
|-------------|----------|----------|---|--------|------------------|-----------------|-----------------|
| <i>PON1</i> | A        | SALS     | Probable lab supported                    | F      | 81               | Bulbar          | 35 <sup>a</sup> |
|             | B        | SALS     | Probable                                  | F      | 54               | Cervical        | 25 <sup>a</sup> |
|             | C        | SALS     | Possible                                  | F      | 70               | Bulbar          | 47 <sup>a</sup> |
|             | D        | SALS     | Probable                                  | M      | 59               | Lumbosacral     | 23 <sup>a</sup> |
|             | E        | SALS     | Probable                                  | M      | 66               | Cervical        | > 20            |
|             | F        | SALS     | Possible                                  | M      | 65               | Cervical        | 55 <sup>a</sup> |
|             | G        | SALS     | Probable                                  | F      | 79               | Bulbar          | 43 <sup>a</sup> |
|             | H        | SALS     | Possible                                  | M      | 81               | Lumbosacral     | 16 <sup>a</sup> |
| <i>PON3</i> | I        | SALS     | Suspected                                 | M      | 65               | Cervical        | 22 <sup>a</sup> |
|             | J        | SALS     | Definite                                  | F      | 75               | Lumbosacral     | 40 <sup>a</sup> |
|             | K        | FALS     | Definite                                  | F      | 51               | Lumbosacral     | 13 <sup>a</sup> |
|             | L        | SALS     | Possible                                  | F      | 71               | Lumbosacral     | 32 <sup>a</sup> |
|             | M        | SALS     | Possible                                  | M      | 61               | Cervical        | 35 <sup>a</sup> |
|             | N        | SALS     | Probable                                  | M      | 64               | Bulbar          | 14 <sup>a</sup> |
|             | O        | FALS     | Possible                                  | F      | 52               | Cervical        | 61 <sup>a</sup> |
|             | P        | SALS     | Probable                                  | M      | 50               | Spinal          | 31 <sup>a</sup> |
|             | Q        | SALS     | Possible                                  | F      | 27               | Lumbosacral     | > 182           |
|             | R        | SALS     | Probable                                  | F      | 75               | Bulbar          | 56 <sup>a</sup> |
| S           | SALS     | Possible | M   | 69     | Lumbosacral      | 16 <sup>a</sup> |                 |
|             |          |          | Average                                   | 53% F  | 64 y             | 26% Bulbar      | 3.4 y           |

Abbreviations: F = female, M = male, y = years, and m = months. Fifty-three percent of the identified patients was female; their average age at onset was 64 years and their disease duration 3.4 years. ALS presented with bulbar symptoms in 26% of these patients. <sup>a</sup> Deceased. <sup>b</sup> c.880-882del.

**Supplementary Table 3.3** *PON* polymorphisms in Dutch GWAS data

| Gene        | SNP                   | Location | OR ADD | P-value ADD | OR DOM | P-value DOM | OR REC | P-value REC |
|-------------|-----------------------|----------|--------|-------------|--------|-------------|--------|-------------|
| <i>PON1</i> | rs854555              | Intron   | 0.94   | 0.34        | 0.94   | 0.47        | 0.88   | 0.37        |
|             | rs3917548             | Intron   | 1.34   | 0.02        | 1.37   | 0.01        | 0.67   | 0.70        |
|             | <b>rs662 (=Q192R)</b> | Exon 6   | 0.98   | 0.80        | 0.99   | 0.89        | 0.94   | 0.72        |
|             | rs2074354             | Intron   | 0.80   | 0.05        | 0.75   | 0.02        | 1.40   | 0.42        |
|             | <b>rs3917498</b>      | Intron   | 1.05   | 0.41        | 1.11   | 0.25        | 0.98   | 0.91        |
|             | rs854561              | Intron   | 0.95   | 0.41        | 1.01   | 0.92        | 0.78   | 0.07        |
|             | rs2299260             | Intron   | 0.93   | 0.40        | 0.95   | 0.62        | 0.69   | 0.22        |
| <i>PON3</i> | <b>rs1053275</b>      | Exon 4   | 1.01   | 0.83        | 0.94   | 0.51        | 1.12   | 0.28        |
|             | rs978903              | Intron   | 1.01   | 0.85        | 0.93   | 0.46        | 1.12   | 0.27        |
|             | <b>rs13226149</b>     | Exon 1   | 0.96   | 0.58        | 0.96   | 0.65        | 0.92   | 0.65        |
| <i>PON2</i> | rs10487133            | Intron   | 0.92   | 0.39        | 0.89   | 0.26        | 1.26   | 0.50        |
|             | rs1639                | Intron   | 1.09   | 0.24        | 1.07   | 0.43        | 1.35   | 0.13        |
|             | rs2299267             | Intron   | 1.08   | 0.33        | 1.05   | 0.62        | 1.50   | 0.08        |

Abbreviations: SNP = single nucleotide polymorphism; OR = Odds ratio, ADD = additive model, DOM = dominant model, and REC = recessive model. SNPs highlighted in bold were also present in our sequence data (Table 3.3). To reach significance, p-values should have been below 0.0038 (Bonferroni correction:  $\alpha/n = 0.05/13 = 0.0038$ ).

## Supplementary Figure

p. F293del




```

Human      CTCTGATGCAGGAGGATTCTCTGAGTCATAGAGAGAAGATTTTCATGCCATTGGGATGGCA 60
Rhesus     CTCGGATGCAGGAGGATTCTCTGAGTCATAGAGAGAAGACTTTCATGCCATTGGGATGGCA 60
Dog        CTCTGATGCGGGAGGATTCTCCGAGTCATAGAGAGAAGATCCTTATGCCATTGGGATGGCA 60
Elephant   CTCTGATGTAGGAGGATTCTTTTCGTCATAGAGAGAAGAGTCTCATGCCATTGGGATGGCA 60
Mouse      CTCTGAGCCGGGAGGATTCTCTGCGTCATAGAAAAAGATCCTCATTCCGTTGGGATGGCA 60
X.tropicalis CTCAGACCCAGGAACATCATCAGAATTATAAAAAACAGCTTCCATGCATTGGGTGGCA 60
Zebrafish  CTCAGAGCCAGCCGGATCATTGGATCAAAAAGAAAGAAATTTGAAAGCATTGGATGACA 60
*** ** * ** * ** * ** * ** * ** * ** * ** * ** * ** * ** *

```

p. I142V

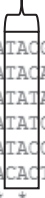


```

Human      TATACCAGAGAACGTTGTTGTTCCCTCAAATTTAAATATCTCCACAGTGGACTTCATGTGG 60
Rhesus     TATACCAGAGAACGTTGTTGTTCCCTCAAATTTAAATATCTCCACGGTGGACTTCATGTGG 60
Elephant   TGTACGAGAGAACGTTGTTGTTCCCTCAAATTTAAATATCTCCACTGTGGACTTCATGTGG 60
Dog        TGTACAAGAGAACGTTGTTGTTCCCTCAAACITTAATTTCTCCACGGTGGACTTCATGTGG 60
Mouse      TGGATGAGAGAGCGTTGTTGTTCTTCAAACITTAATATCTCCACAGTGGAGTCCATGTTG 60
X.tropicalis TGCAAAAGAGCATTTTCCCTCTTCTTCAAACITTAACAGCTCAACAGTGCCTTTTATAGTGA 60
Zebrafish  TATTCAGAGCATTTTCAATTCCTCAAAAATCTGAATAATCTCCACTTGACTTTTGCCITGA 60
*      **** ** * ** * ** * ** * ** * ** * ** * ** *

```

p.V345I



```

Human      CTCACAGTACAGAGTTTTGTGAATACCGTGCCTATGAGAATTTCCCATGGTACACAGA 60
Rhesus     CTCACAATACAGAGTTTTGTGAATACAGTGCCTATGAGAATTTCCCATGGTACACGGA 60
Mouse      GTCACAGTACAGAGCTTTGTGAATATAGTACCTATGAGCATTCTTTATGATACACAGA 60
Elephant   TTCACAGTACAGAACTCCATGAATATCGTGCCAATGAGAAGTTTTTCATGATACATGGA 60
Dog        CAAACAGTACAGAGCTTTGTGAATACCGTGCCTATGAGAAGTTTTCCGTGGTACACAGA 60
X.tropicalis CTTACAGTACAGAGCTTTATGGAACACTGTGCCGATCAGTAGTTTTCCCTCGTACACAAC 60
*** ***** * ** * ** * ** * ** * ** * ** * ** * ** *

```

**Supplementary Figure 3.1** Evolutionary conservation of *PON* mutations unique for ALS patients. Conservation of nucleotides across species was generated using ClustalW2 online tool, <http://www.ebi.ac.uk/Tools/msa/clustalw2/>. See Appendix page 379 for Supplementary Figure 3.1 in color.

## Supplementary References

- (1) Ticozzi N, Leclerc AL, Keagle PJ et al. Paraoxonase gene mutations in amyotrophic lateral sclerosis. *Ann Neurol* 2010;68:102-107.



# 4

**“The brain consists of very small globules which appear to me a hundred times smaller than the diameter of a grain of sand.”**

The Collected Letters of  
Antoni van Leeuwenhoek.

# Novel optineurin mutations in sporadic amyotrophic lateral sclerosis patients

Marka van Blitterswijk, Paul W.J. van Vught,  
Michael A. van Es, Helenius J. Schelhaas,  
Anneke J. van der Kooi, Marianne de Visser,  
Jan H. Veldink\*, Leonard H. van den Berg\*

\* Contributed equally to this work.

## Abstract

Optineurin (*OPTN*) mutations have been reported in a cohort of Japanese patients with familial (FALS) and sporadic (SALS) amyotrophic lateral sclerosis. In Caucasian patients, *OPTN* mutations have been identified in FALS patients, but were not detected in a cohort of 95 SALS patients. Moreover, single nucleotide polymorphisms (SNPs) in *OPTN* that could raise ALS susceptibility have not been investigated. Therefore, we screened a large Dutch cohort of 1,191 patients with SALS, 94 patients with FALS, and 1,415 control subjects for mutations and SNPs in *OPTN*. We identified one novel nonsense mutation (p.Q165X) and one unreported missense mutation (p.Q454E) in individual SALS patients. These patients demonstrated rapid disease progression with an average survival of 24.5 months. No heterozygous or homozygous *OPTN* mutations were identified in our cohort of FALS patients. SNP analysis did not reveal significant differences between ALS patients and control subjects. Thus, variations in *OPTN* appear to be a rare cause of rapidly progressive SALS in The Netherlands.



## Introduction

Amyotrophic lateral sclerosis (ALS) is a fatal neurodegenerative disorder, affecting upper and lower motor neurons. Patients can experience progressive muscle weakness in their limbs and trunk, and in muscles involved in speech, swallowing and breathing, eventually causing respiratory failure in three to five years. Although Charcot once described ALS as “one of the most completely understood conditions in the realm of clinical neurology”,<sup>1</sup> its pathogenesis turned out to be complex, involving both genetic and environmental components. In approximately ten percent of the cases, family history suggests a genetic cause, but even in these familial ALS patients (FALS), most of the causes are still unknown. Mutations in superoxide dismutase-1 (*SOD1*), angiogenin (*ANG*), fused in sarcoma / translated in liposarcoma (*FUS/TLS*), TAR DNA-binding protein (*TARDBP*), vesicle-associated membrane protein B (*VAPB*), and valosin-containing protein (*VCP*) account for approximately thirty percent of these FALS patients.<sup>2-4</sup> Nevertheless, mutation frequencies vary substantially among populations; for instance, although *SOD1* mutations are generally detected in around 20% of FALS patients, they are only present in 1.8% of Dutch FALS patients.<sup>5</sup> Furthermore, despite evidence for a role of genetic components in FALS, genetic variants that are involved in sporadic ALS (SALS) remain elusive.<sup>6-22</sup>

Optineurin (*OPTN*) mutations were originally identified in patients with primary open-angle glaucoma (POAG).<sup>23</sup> Replication studies in glaucoma patients reported few novel mutations; however, several single nucleotide polymorphisms (SNPs) appeared to be associated with glaucoma.<sup>24-49</sup> Mutations in *OPTN* were also detected in ALS patients from Japan.<sup>50</sup> A homozygous deletion of exon five, a homozygous p.Q398X mutation, and a heterozygous p.E478G mutation were reported, accounting for ~4% of the FALS patients and less than 0.5% of the SALS patients. Interestingly, these Japanese patients demonstrated slow disease progression. Recently, a cohort of 221 FALS and 95 SALS patients of French and French-Canadian descent, were screened for mutations in *OPTN* as well. Although new mutations in FALS patients were detected in this cohort, no mutations were present in SALS patients (Supplementary Table 4.1).<sup>51;52</sup> To date, SNPs in *OPTN* that could potentially raise ALS susceptibility have not been investigated.

To assess the frequency of mutations and SNPs in *OPTN*, we decided to screen a large cohort of FALS and SALS patients and control subjects of Dutch descent. Moreover, we assessed clinical characteristics of patients with *OPTN* mutations.

**Table 4.1** Genetic variation found in *OPTN*

| Mutation | Exon | FALS<br>(n = 94) | SALS<br>(n = 1,191) | CON<br>(n = 1,415) | Prediction<br>(PolyPhen-2) |
|----------|------|------------------|---------------------|--------------------|----------------------------|
| p.L100L  | 5    | 0                | 0                   | 1                  | N/A                        |
| p.A134A  | 6    | 0                | 1                   | 0                  | N/A                        |
| p.G159V  | 6    | 0                | 1                   | 1                  | Probably damaging          |
| p.L164L  | 6    | 0                | 0                   | 1                  | N/A                        |
| p.Q165X  | 6    | 0                | 1                   | 0                  | N/A                        |
| p.Q454E  | 13   | 0                | 1                   | 0                  | Possibly damaging          |

Abbreviations: FALS = familial amyotrophic lateral sclerosis, SALS = sporadic amyotrophic lateral sclerosis, CON = control subjects, n = number, and N/A = not applicable.

## Materials and methods

### Study population

We included 1,285 ALS patients; 94 from 80 different families had a family history of ALS. Patients were diagnosed with ALS according to the El Escorial Criteria<sup>53,54</sup> at national referral centers for neuromuscular diseases (University Medical Center Utrecht, Academic Medical Center Amsterdam, and Radboud University Nijmegen Medical Center). FALS patients had already been screened for mutations in *SOD1*, *ANG*, *FUS/TLS*, *TARDBP*, *VAPB*, and *VCP*. We used 1,415 control subjects of Dutch descent for sequencing and a total of 1,894 control subjects for Taqman analysis (Applied Biosystems, Foster City, CA, USA). Patient material was obtained with approval of the Institutional Review Board, and all participants gave informed consent.

### Genetic analysis

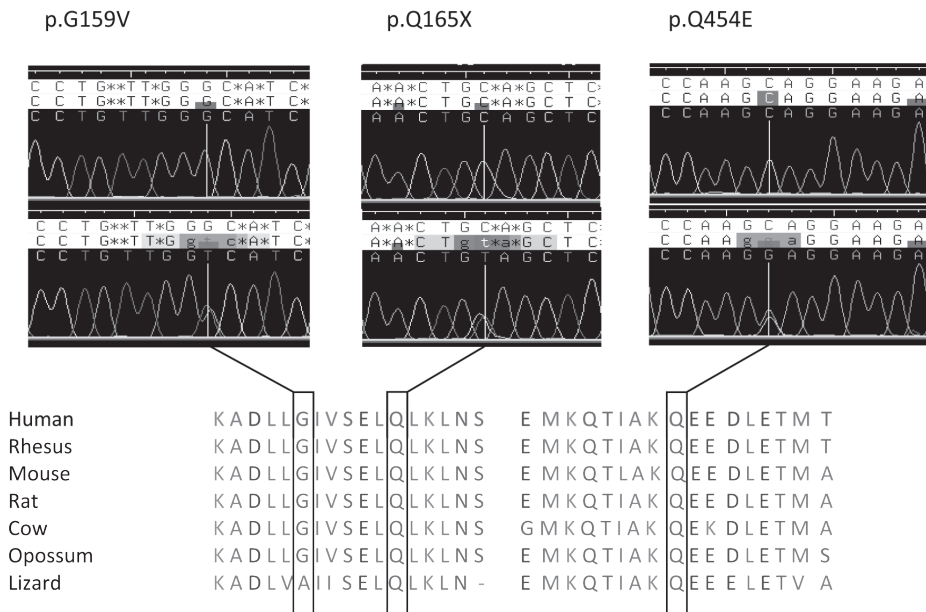
ALS patients and control subjects were screened for mutations in coding regions of *OPTN* (NM\_001008213). We used previously described primers for amplification by touchdown PCR.<sup>50</sup> BigDye Terminator 3.1 sequencing kit (Applied Biosystems), DNA Analyzer 3730XL and PolyPhred were used for sequencing and data analysis.<sup>55</sup> Mutations were confirmed on genomic DNA and analyzed with PolyPhen-2 to predict the impact of these mutations on the structure and function of *OPTN* (<http://genetics.bwh.harvard.edu/pph2/>).

Sequence data was also used to determine allele frequencies of SNPs. When SNP call rates were below eighty percent, we selected SNPs for Taqman assays on all our ALS patients and 1,894 control subjects. For these Taqman assays, 1  $\mu$ L of ~50 ng genomic

DNA per sample was mixed with 2.5  $\mu$ L Taqman master mix (Applied Biosystems), 0.1  $\mu$ L assay mix (Applied Biosystems) and 1.4  $\mu$ L ddH<sub>2</sub>O. We used the following PCR program: denaturation at 95°C for ten minutes, followed by forty cycles of denaturation at 92°C for fifteen seconds and annealing and extension at 60°C for one minute. We analyzed PCR products with an ABI Prism 7900HT Sequence Detection System and SDS 2.3 software (Applied Biosystems). Chi-square tests were used to calculate deviations from the Hardy-Weinberg equilibrium in our control cohort. SNPs that were not in Hardy-Weinberg equilibrium (p-value < 0.05) in this cohort were excluded from further analysis.

## Results

One nonsense mutation (p.Q165X), two missense mutations (p.Q454E, p.G159V), and three silent mutations were detected in our Dutch cohort (Table 4.1/Figure 4.1). The p.Q165X and p.Q454E mutations were each present in one SALS patient. The p.G159V mutation was present in one SALS patient and one control subject.



**Figure 4.1** *OPTN* mutations and conservation. Conservation of amino acid residues across species was generated using ClustalW2 online tool, <http://www.ebi.ac.uk/Tools/msa/clustalw2/>. See Appendix page 380 for Figure 4.1 in color.

### Nonsense and missense mutations

In patient A we detected a heterozygous c.495C>T variation, changing glutamine into a premature stop codon at position 165 (p.Q165X). Although *OPTN* normally contains 577 amino acids, this mutation causes a premature stop during translation, truncating the protein by 72%. The truncated protein lacks several coiled coil areas, a leucine zipper, zinc finger, and subsequently, binding sites for Rab8, group 1 metabotropic glutamate receptors (mGluR1a), transcription factor IIIA-interacting protein (TFIIIA), Myosin VI and huntingtin (Htt).<sup>56</sup>

In addition, we detected a heterozygous c.1362C>G missense mutation in a SALS patient (B), resulting in a glutamine to glutamic acid change at codon 454 (p.Q454E). This amino acid change could be damaging and is located in a well conserved region (Figure 4.1). The second missense variant was present in another SALS patient (C): a novel heterozygous c.477G>T variant, substituting glycine for valine at position 159 (p.G159V). This variant could be damaging, and is located in a well conserved region. Nevertheless, it was also detected in one control subject diagnosed with hypercholesterolemia and mild chronic kidney disease due to hypertension. This control subject is currently 62 years of age and has no neurological complaints. Therefore, in spite of its localization within the binding site of Rab8, p.G159V most likely represents a rare but benign polymorphism.

### Polymorphisms

While screening sequence data for mutations we encountered thirteen SNPs, and decided to compare their frequencies in FALS, SALS and control subjects. To ensure call rates above eighty percent, we performed Taqman assays for two SNPs: rs2234968 (p.T34T) and rs11258194 (p.M98K). We excluded three intronic SNPs based on significant deviations from the Hardy-Weinberg equilibrium in our control subjects (rs765884, rs676302, rs7086894). As can be seen in Supplementary Table 4.2, none of the SNPs appears to be associated with ALS.

### Clinical characteristics

A detailed description of signs and symptoms is given in Table 4.2 and in the Supplementary Clinical information. Briefly, one of the SALS patients with a p.Q165X or p.Q454E mutation was female (50%) and the average age at onset was 75 years. One of them presented with bulbar symptoms (50%) and the average survival time was relatively short at 24.5 months (range 23 – 26).

**Table 4.2** Clinical characteristics of patients with *OPTN* mutations

| Patient | Mutation | Gender | El Escorial criteria    | Age at onset (y) | Site of onset | Survival (m) <sup>a</sup> |
|---------|----------|--------|-------------------------|------------------|---------------|---------------------------|
| A       | p.Q165X  | F      | Probable, lab supported | 83               | Cervical      | 23                        |
| B       | p.Q454E  | M      | Probable                | 67               | Bulbar        | 26                        |
| C       | p.G159V  | F      | Possible                | 58               | Lumbosacral   | 28                        |
| D       | p.A134A  | M      | Definite                | 40               | Bulbar        | 45                        |

Abbreviations: F = female, M = male, y = years, and m = months. <sup>a</sup> All patients are deceased.

## Discussion

Here, we report two novel *OPTN* mutations: a nonsense mutation (p.Q165X) and one missense mutation (p.Q454E). Each of these mutations was detected in one SALS patient. Since the p.Q165X mutation would probably result in a 72% truncated *OPTN* protein, binding of Rab8, mGluR1a, TFIIIA, Htt and Myosin VI might be hindered.<sup>56</sup> The p.Q454E mutation is located in a leucine zipper and coiled coil area that contains binding sites for Htt and Myosin VI. The localization of these two mutations, their predicted effects and absence in our control cohort, suggest that they are pathogenic. They could, therefore, affect membrane trafficking, Golgi ribbon formation, exocytosis, cellular morphogenesis, neuronal function, and transcription activation.<sup>57-62</sup>

Currently, only a small number of *OPTN* mutations has been described in ALS patients. A homozygous deletion of exon five has been reported in two Japanese siblings from a consanguineous marriage, both of whom had ALS.<sup>50</sup> Furthermore, a homozygous p.Q398X mutation was detected in another Japanese ALS patient from a consanguineous marriage, and also in one individual with apparently SALS.<sup>50</sup> This nonsense mutation caused a premature stop during translation, truncating the protein by 31%. A heterozygous p.E478G and p.A93P mutation were identified in Japanese FALS and SALS patients as well (Supplementary Table 4.1).<sup>50;63</sup> Thus, *OPTN* mutations were present in approximately 4% of the Japanese FALS patients and less than 0.5% of the SALS patients. Recently, Caucasian FALS and SALS patients (221- and 95 patients, respectively) were also screened for mutations in *OPTN*.<sup>51;52</sup> This resulted in the identification of two substitutions and two insertions in their FALS patients; no mutations were present in their SALS patients.<sup>51;52</sup> Whereas mutations in *OPTN* could be a rare cause of SALS, we decided to screen a large Caucasian cohort of 1,191 SALS patients, and detected two

mutations in SALS patients, accounting for less than 0.5% of our cohort. In addition, we screened 94 FALS patients, and showed *OPTN* mutations were absent in this cohort, indicating population-specific differences, as we previously demonstrated for *SOD1*.<sup>5</sup>

The average survival of our two SALS patients with *OPTN* mutations was only 24.5 months. As can be seen in Supplementary Table 4.1, one Caucasian patient with a previously reported c.382\_383insAG variant showed a rapid disease progression of 26 months as well.<sup>52</sup> Japanese patients with *OPTN* mutations, however, showed a relatively slow disease progression.<sup>50</sup> The average survival of Japanese patients (since deceased) was more than thirteen years; patients who were alive at the time of publication, already demonstrated an average disease duration of eight years. Moreover, whilst the average age at onset was 75 years in our two patients, it was only 48 years in these Japanese patients. Although the reported number of patients with *OPTN* mutations is relatively low, these findings could indicate that particular *OPTN* mutations are associated with a different survival and/or age at onset. Similar associations have been reported for *SOD1* mutations. For instance, it has been shown that p.A4V mutations predict shorter survival, while p.G37R, p.G41D and p.G93C mutations predict longer survival as compared to other ALS subgroups.<sup>64,65</sup> Associations between *SOD1* mutations (p.G37R and p.L38V) and an earlier age at onset have also been described.<sup>64</sup> In the French population, one-third of the patients with *SOD1* mutations survived for more than seven years and had an earlier age at onset.<sup>66</sup> Comparable differences were also observed for *FUS/TLS* mutations, as p.R521H mutations are associated with longer disease duration, and p.P525L mutations with shorter disease duration and early onset.<sup>66</sup> Hence, just like *SOD1* and *FUS/TLS* mutations, there may be specific genotype-phenotype relations with regard to *OPTN* mutations.

Mutations in *OPTN* were first described in patients with POAG, causing bilateral blindness.<sup>23</sup> Sequence alterations were found in 16.7% of families with hereditary POAG, including p.E50K and a 2-base pair AG insertion.<sup>23</sup> Currently, many cohorts of glaucoma patients have been screened for *OPTN* mutations, but only few novel *OPTN* mutations have been detected.<sup>27,45-47</sup> Nonetheless, a number of studies have reported associations with *OPTN* SNPs and POAG.<sup>25-44</sup> A recent meta-analysis showed a significant association between rs2234968 (p.T34T) and POAG in Asians and adults.<sup>24</sup> Whereas previous articles have not studied *OPTN* polymorphisms in ALS patients, we decided to screen our patients and control subjects for SNPs in *OPTN*. We included ten SNPs in exons and exon-intron boundaries. For these SNPs, we compared minor allele frequencies between FALS patients, SALS patients and control subjects. No significant differences could be detected between these groups (Supplementary Table 4.2).

To summarize, we have identified p.Q165X- and p.Q454E mutations in a large cohort of SALS patients, and these patients demonstrated rapid disease progression. We did not detect mutations in our FALS patients, nor associations between SNPs and ALS susceptibility. Our findings highlight that the genetic background of ALS differs between different populations, and imply a modest role for OPTN in the pathogenesis of ALS in The Netherlands.

## Acknowledgements

Source of funding: This work was supported by the VSB fonds, The Brain Foundation of The Netherlands, Prinses Beatrix Fonds, Catharijne Stichting, H. Kersten and M. Kersten, J. R. van Dijk, and the Adessium Foundation.

## References

- (1) Rowland LP. How amyotrophic lateral sclerosis got its name: the clinical-pathologic genius of Jean-Martin Charcot. *Arch Neurol* 2001;58:512-515.
- (2) Rowland LP, Shneider NA. Amyotrophic lateral sclerosis. *N Engl J Med* 2001;344:1688-1700.
- (3) Valdmanis PN, Rouleau GA. Genetics of familial amyotrophic lateral sclerosis. *Neurology* 2008;70:144-152.
- (4) Van Damme P, Robberecht W. Recent advances in motor neuron disease. *Curr Opin Neurol* 2009;22:486-492.
- (5) van Es MA, Dahlberg C, Birve A, Veldink JH, van den Berg LH, Andersen PM. Large-scale SOD1 mutation screening provides evidence for genetic heterogeneity in amyotrophic lateral sclerosis. *J Neurol Neurosurg Psychiatry* 2010;81:562-566.
- (6) van Es MA, Veldink JH, Saris CG et al. Genome-wide association study identifies 19p13.3 (UNC13A) and 9p21.2 as susceptibility loci for sporadic amyotrophic lateral sclerosis. *Nat Genet* 2009;41:1083-1087.
- (7) Schymick JC, Scholz SW, Fung HC et al. Genome-wide genotyping in amyotrophic lateral sclerosis and neurologically normal controls: first stage analysis and public release of data. *Lancet Neurol* 2007;6:322-328.
- (8) Schymick JC, Talbot K, Traynor BJ. Genetics of sporadic amyotrophic lateral sclerosis. *Hum Mol Genet* 2007;16 Spec No. 2:R233-R242.
- (9) Shatunov A, Mok K, Newhouse S et al. Chromosome 9p21 in sporadic amyotrophic lateral sclerosis in the UK and seven other countries: a genome-wide association study. *Lancet Neurol* 2010;9:986-994.

- (10) van Es MA, van Vught PW, Veldink JH et al. Analysis of FGGY as a risk factor for sporadic amyotrophic lateral sclerosis. *Amyotroph Lateral Scler* 2009;10:441-447.
- (11) Sha Q, Zhang Z, Schymick JC, Traynor BJ, Zhang S. Genome-wide association reveals three SNPs associated with sporadic amyotrophic lateral sclerosis through a two-locus analysis. *BMC Med Genet* 2009;10:86.
- (12) Fernandez-Santiago R, Sharma M, Berg D et al. No evidence of association of FLJ10986 and ITPR2 with ALS in a large German cohort. *Neurobiol Aging* 2011;32:551.e1-e4.
- (13) Chio A, Schymick JC, Restagno G et al. A two-stage genome-wide association study of sporadic amyotrophic lateral sclerosis. *Hum Mol Genet* 2009;18:1524-1532.
- (14) Cronin S, Berger S, Ding J et al. A genome-wide association study of sporadic ALS in a homogenous Irish population. *Hum Mol Genet* 2008;17:768-774.
- (15) Cronin S, Tomik B, Bradley DG, Slowik A, Hardiman O. Screening for replication of genome-wide SNP associations in sporadic ALS. *Eur J Hum Genet* 2009;17:213-218.
- (16) Wills AM, Cronin S, Slowik A et al. A large-scale international meta-analysis of paraoxonase gene polymorphisms in sporadic ALS. *Neurology* 2009;73:16-24.
- (17) Laaksovirta H, Peuralinna T, Schymick JC et al. Chromosome 9p21 in amyotrophic lateral sclerosis in Finland: a genome-wide association study. *Lancet Neurol* 2010;9:978-985.
- (18) Li XG, Zhang JH, Xie MQ et al. Association between DPP6 polymorphism and the risk of sporadic amyotrophic lateral sclerosis in Chinese patients. *Chin Med J (Engl)* 2009;122:2989-2992.
- (19) Landers JE, Melki J, Meininger V et al. Reduced expression of the Kinesin-Associated Protein 3 (KIFAP3) gene increases survival in sporadic amyotrophic lateral sclerosis. *Proc Natl Acad Sci USA* 2009;106:9004-9009.
- (20) Simpson CL, Lemmens R, Miskiewicz K et al. Variants of the elongator protein 3 (ELP3) gene are associated with motor neuron degeneration. *Hum Mol Genet* 2009;18:472-481.
- (21) van Es MA, van Vught PW, Blauw HM et al. Genetic variation in DPP6 is associated with susceptibility to amyotrophic lateral sclerosis. *Nat Genet* 2008;40:29-31.
- (22) van Es MA, van Vught PW, Blauw HM et al. ITPR2 as a susceptibility gene in sporadic amyotrophic lateral sclerosis: a genome-wide association study. *Lancet Neurol* 2007;6:869-877.
- (23) Rezaie T, Child A, Hitchings R et al. Adult-onset primary open-angle glaucoma caused by mutations in optineurin. *Science* 2002;295:1077-1079.
- (24) Cheng JW, Li P, Wei RL. Meta-analysis of association between optineurin gene and primary open-angle glaucoma. *Med Sci Monit* 2010;16:CR369-CR377.
- (25) Aung T, Ebenezer ND, Brice G et al. Prevalence of optineurin sequence variants in adult primary open angle glaucoma: implications for diagnostic testing. *J Med Genet* 2003;40:e101.



- (26) Funayama T, Ishikawa K, Ohtake Y et al. Variants in optineurin gene and their association with tumor necrosis factor-alpha polymorphisms in Japanese patients with glaucoma. *Invest Ophthalmol Vis Sci* 2004;45:4359-4367.
- (27) Fuse N, Takahashi K, Akiyama H et al. Molecular genetic analysis of optineurin gene for primary open-angle and normal tension glaucoma in the Japanese population. *J Glaucoma* 2004;13:299-303.
- (28) Umeda T, Matsuo T, Nagayama M, Tamura N, Tanabe Y, Ohtsuki H. Clinical relevance of optineurin sequence alterations in Japanese glaucoma patients. *Ophthalmic Genet* 2004;25:91-99.
- (29) Fan BJ, Wang DY, Fan DS et al. SNPs and interaction analyses of myocilin, optineurin, and apolipoprotein E in primary open angle glaucoma patients. *Mol Vis* 2005;11:625-631.
- (30) Melki R, Belmouden A, Akhayat O, Brezin A, Garchon HJ. The M98K variant of the OPTINEURIN (OPTN) gene modifies initial intraocular pressure in patients with primary open angle glaucoma. *J Med Genet* 2003;40:842-844.
- (31) Baird PN, Richardson AJ, Craig JE, Mackey DA, Rohtchina E, Mitchell P. Analysis of optineurin (OPTN) gene mutations in subjects with and without glaucoma: the Blue Mountains Eye Study. *Clin Experiment Ophthalmol* 2004;32:518-522.
- (32) Toda Y, Tang S, Kashiwagi K et al. Mutations in the optineurin gene in Japanese patients with primary open-angle glaucoma and normal tension glaucoma. *Am J Med Genet A* 2004;125A:1-4.
- (33) Mukhopadhyay A, Komatireddy S, Acharya M et al. Evaluation of Optineurin as a candidate gene in Indian patients with primary open angle glaucoma. *Mol Vis* 2005;11:792-797.
- (34) Sripriya S, Nirmaladevi J, George R et al. OPTN gene: profile of patients with glaucoma from India. *Mol Vis* 2006;12:816-820.
- (35) Craig JE, Hewitt AW, Dimasi DP et al. The role of the Met98Lys optineurin variant in inherited optic nerve diseases. *Br J Ophthalmol* 2006;90:1420-1424.
- (36) Funayama T, Mashima Y, Ohtake Y et al. SNPs and interaction analyses of noelin 2, myocilin, and optineurin genes in Japanese patients with open-angle glaucoma. *Invest Ophthalmol Vis Sci* 2006;47:5368-5375.
- (37) Hauser MA, Sena DF, Flor J et al. Distribution of optineurin sequence variations in an ethnically diverse population of low-tension glaucoma patients from the United States. *J Glaucoma* 2006;15:358-363.
- (38) Liu Y, Akafo S, Santiago-Turla C et al. Optineurin coding variants in Ghanaian patients with primary open-angle glaucoma. *Mol Vis* 2008;14:2367-2372.
- (39) Yen YC, Yang JJ, Chou MC, Li SY. Absence of optineurin (OPTN) gene mutations in Taiwanese patients with juvenile-onset open-angle glaucoma. *Mol Vis* 2008;14:487-494.
- (40) Wolf C, Gramer E, Muller-Myhsok B et al. Evaluation of nine candidate genes in patients with normal tension glaucoma: a case control study. *BMC Med Genet* 2009;10:91.

- (41) Caixeta-Umbelino C, de Vasconcellos JP, Costa VP et al. Lack of association between optineurin gene variants T34T, E50K, M98K, 691\_692insAG and R545Q and primary open angle glaucoma in Brazilian patients. *Ophthalmic Genet* 2009;30:13-18.
- (42) Jia LY, Tam PO, Chiang SW et al. Multiple gene polymorphisms analysis revealed a different profile of genetic polymorphisms of primary open-angle glaucoma in northern Chinese. *Mol Vis* 2009;15:89-98.
- (43) McDonald KK, Abramson K, Beltran MA et al. Myocilin and optineurin coding variants in Hispanics of Mexican descent with POAG. *J Hum Genet* 2010;55:697-700.
- (44) Alward WL, Kwon YH, Kawase K et al. Evaluation of optineurin sequence variations in 1,048 patients with open-angle glaucoma. *Am J Ophthalmol* 2003;136:904-910.
- (45) Leung YF, Fan BJ, Lam DS et al. Different optineurin mutation pattern in primary open-angle glaucoma. *Invest Ophthalmol Vis Sci* 2003;44:3880-3884.
- (46) Weisschuh N, Neumann D, Wolf C, Wissinger B, Gramer E. Prevalence of myocilin and optineurin sequence variants in German normal tension glaucoma patients. *Mol Vis* 2005;11:284-287.
- (47) Kumar A, Basavaraj MG, Gupta SK et al. Role of CYP1B1, MYOC, OPTN, and OPTC genes in adult-onset primary open-angle glaucoma: predominance of CYP1B1 mutations in Indian patients. *Mol Vis* 2007;13:667-676.
- (48) Tang S, Toda Y, Kashiwagi K et al. The association between Japanese primary open-angle glaucoma and normal tension glaucoma patients and the optineurin gene. *Hum Genet* 2003;113:276-279.
- (49) Forsman E, Lemmela S, Varilo T et al. The role of TIGR and OPTN in Finnish glaucoma families: a clinical and molecular genetic study. *Mol Vis* 2003;9:217-222.
- (50) Maruyama H, Morino H, Ito H et al. Mutations of optineurin in amyotrophic lateral sclerosis. *Nature* 2010;465:223-226.
- (51) Belzil VV, Daoud H, Desjarlais A et al. Analysis of OPTN as a causative gene for amyotrophic lateral sclerosis. *Neurobiol Aging* 2011;32:555.e13-e14.
- (52) Millecamps S, Boillee S, Chabrol E et al. Screening of OPTN in French familial amyotrophic lateral sclerosis. *Neurobiol Aging* 2011;32:557.e11-e13.
- (53) Brooks BR, Miller RG, Swash M, Munsat TL. El Escorial revisited: revised criteria for the diagnosis of amyotrophic lateral sclerosis. *Amyotroph Lateral Scler Other Motor Neuron Disord* 2000;1:293-299.
- (54) Brooks BR. El Escorial World Federation of Neurology criteria for the diagnosis of amyotrophic lateral sclerosis. Subcommittee on Motor Neuron Diseases/Amyotrophic Lateral Sclerosis of the World Federation of Neurology Research Group on Neuromuscular Diseases and the El Escorial "Clinical limits of amyotrophic lateral sclerosis" workshop contributors. *J Neurol Sci* 1994;124 Suppl:96-107.
- (55) Nickerson DA, Tobe VO, Taylor SL. PolyPhred: automating the detection and genotyping of single nucleotide substitutions using fluorescence-based resequencing. *Nucleic Acids Res* 1997;25:2745-2751.
- (56) Chalasani ML, Swarup G, Balasubramanian D. Optineurin and its mutants: molecules associated with some forms of glaucoma. *Ophthalmic Res* 2009;42:176-184.

- (57) Hattula K, Peranen J. FIP-2, a coiled-coil protein, links Huntingtin to Rab8 and modulates cellular morphogenesis. *Curr Biol* 2000;10:1603-1606.
- (58) Sahlender DA, Roberts RC, Arden SD et al. Optineurin links myosin VI to the Golgi complex and is involved in Golgi organization and exocytosis. *J Cell Biol* 2005;169:285-295.
- (59) Weisschuh N, Alavi MV, Bonin M, Wissinger B. Identification of genes that are linked with optineurin expression using a combined RNAi--microarray approach. *Exp Eye Res* 2007;85:450-461.
- (60) Anborgh PH, Godin C, Pampillo M et al. Inhibition of metabotropic glutamate receptor signaling by the huntingtin-binding protein optineurin. *J Biol Chem* 2005;280:34840-34848.
- (61) Li Y, Kang J, Horwitz MS. Interaction of an adenovirus E3 14.7-kilodalton protein with a novel tumor necrosis factor alpha-inducible cellular protein containing leucine zipper domains. *Mol Cell Biol* 1998;18:1601-1610.
- (62) Moreland RJ, Dresser ME, Rodgers JS et al. Identification of a transcription factor IIIA-interacting protein. *Nucleic Acids Res* 2000;28:1986-1993.
- (63) Iida A, Hosono N, Sano M et al. Optineurin mutations in Japanese amyotrophic lateral sclerosis. *J Neurol Neurosurg Psychiatry* 2012;83:233-235.
- (64) Cudkovicz ME, Kenna-Yasek D, Sapp PE et al. Epidemiology of mutations in superoxide dismutase in amyotrophic lateral sclerosis. *Ann Neurol* 1997;41:210-221.
- (65) Regal L, Vanopdenbosch L, Tilkin P et al. The G93C mutation in superoxide dismutase 1: clinicopathologic phenotype and prognosis. *Arch Neurol* 2006;63:262-267.
- (66) Millicamps S, Salachas F, Cazeneuve C et al. SOD1, ANG, VAPB, TARDBP, and FUS mutations in familial amyotrophic lateral sclerosis: genotype-phenotype correlations. *J Med Genet* 2010;47:554-560.

## SUPPLEMENT

### Supplementary Tables

**Supplementary Table 4.1** *OPTN* mutations reported in ALS patients

| Study                          | Cohort                     | Mutation         | Gender  | Family history  | Age at onset (y) | Site of onset | Survival           |   |
|--------------------------------|----------------------------|------------------|---------|-----------------|------------------|---------------|--------------------|---|
| Maruyama et al. <sup>1</sup>   | 76 FALS,                   | Deletion exon 5  | F       | Yes             | 33               | Cervical      | 24 y <sup>b</sup>  |   |
|                                | 16 consanguine             | Deletion exon 5  | M       | Yes             | 36               | Cervical      | 19 y <sup>b</sup>  |   |
|                                | ALS patients,              | p.Q398X          | F       | No <sup>a</sup> | 52               | Bulbar        | 8 y                |   |
|                                | 597 SALS                   | p.Q398X          | F       | No <sup>a</sup> | 44               | Cervical      | 3.5 y              |   |
|                                |                            | p.E478G          | F       | Yes             | 56               | Cervical      | 10 y <sup>b</sup>  |   |
|                                |                            | p.E478G          | F       | Yes             | 64               | Cervical      | 11 y               |   |
|                                |                            | p.E478G          | M       | Yes             | 51               | Lumbosacral   | 11 y               |   |
|                                |                            | p.E478G          | M       | Yes             | 49               | Bulbar        | 1.5 y <sup>b</sup> |   |
|                                | Iida et al. <sup>2,c</sup> | 26 FALS,         | p.A93P  | -               | No               | -             | Spinal             | - |
|                                |                            | 697 SALS         | p.E478G | -               | No               | -             | Bulbar             | - |
|                                |                            | p.E478G          | -       | Yes             | -                | Bulbar        | -                  |   |
| Belzil et al. <sup>3</sup>     | 95 FALS,                   | p.A481V          | -       | Yes             | -                | -             | -                  |   |
|                                | 95 SALS                    | c.1242+1G>A_insA | -       | Yes             | -                | -             | -                  |   |
| Millecamps et al. <sup>4</sup> | 126 FALS                   | c.382_383insAG   | -       | Yes             | 46               | -             | 26 m <sup>b</sup>  |   |
|                                |                            | p.R96L           | -       | Yes             | 56               | Lumbosacral   | 38 m <sup>b</sup>  |   |
| Present study                  | 94 FALS,                   | p.Q165X          | F       | No              | 83               | Cervical      | 23 m <sup>b</sup>  |   |
|                                | 1,191 SALS                 | p.Q454E          | M       | No              | 67               | Bulbar        | 26 m <sup>b</sup>  |   |

Abbreviations: ALS = amyotrophic lateral sclerosis; FALS = familial ALS, SALS = sporadic ALS, F = female, M = male, y = years, and m = months. <sup>a</sup> No family members with ALS have been reported, but these patients were probably derived from a single ancestor. <sup>b</sup> Deceased. <sup>c</sup> Supplementary information not available yet.

**Supplementary Table 4.2** Minor allele frequencies of SNPs in *OPTN*

|                 | Location     | FALS <sup>a</sup> | SALS <sup>a</sup> | CON <sup>b</sup> |
|-----------------|--------------|-------------------|-------------------|------------------|
| <b>Sequence</b> |              |                   |                   |                  |
| rs2304706       | Intron 1-2   | 0.13              | 0.15              | 0.15             |
| rs41291307      | Intron 1-2   | 0.01              | 0.01              | 0.01             |
| rs11258191      | Intron 1-2   | 0.00              | 0.01              | 0.01             |
| rs41291309      | Exon 2       | 0.01              | 0.01              | 0.01             |
| rs2244380       | Intron 6-7   | 0.21              | 0.19              | 0.19             |
| GA008639        | Exon 6       | <0.01             | <0.01             | <0.01            |
| rs77873111      | Intron 14-15 | 0.01              | 0.01              | 0.01             |
| rs10906310      | Intron 15-16 | 0.23              | 0.25              | 0.23             |
| <b>Taqman</b>   |              |                   |                   |                  |
| rs2234968       | Exon 4       | 0.31              | 0.26              | 0.26             |
| rs11258194      | Exon 5       | 0.03              | 0.03              | 0.03             |

Abbreviation: CON = control subjects. <sup>a</sup> No significant differences in allele frequencies were detected (p-values not shown for simplicity). P-values were calculated with Chi-square test, either FALS versus CON or SALS versus CON. The following Bonferroni correction was used:  $\alpha/n = 0.05/10 = 0.005$ . <sup>b</sup> Chi-square tests were calculated of control cohort for deviation from Hardy-Weinberg equilibrium. Only SNPs in Hardy-Weinberg equilibrium were included.

## Supplementary Clinical information

Patient A presented with complaints of her left arm at 83 years of age; she experienced difficulty lifting objects. A couple of months later she noticed weakness in her right arm as well. She did not have any sensory symptoms, nor did she experience difficulty walking or talking. Her family history for neurological disorders was negative. Neurological examination demonstrated atrophy in both her arms. Her muscle strength was symmetrically reduced in her arms, and her reflexes were low. No atrophy could be seen in her legs, but her proximal muscle strength was slightly reduced, and her knee reflexes were brisk in both legs. Her forced vital capacity was decreased (59% of the predicted value), and her serum creatine kinase activity was 149 U/L (normal: <200 U/L). An EMG showed involvement of peripheral motor neurons in three regions. She was diagnosed with probable laboratory supported ALS and died within two years of symptom onset. As the parents of patient A were deceased, their DNA was not available for testing.

At 67 years of age, patient B presented with difficulty swallowing and projecting his voice. He experienced abnormal fatigue and shortness of breath, particularly at night. In addition, he developed muscle cramps in his limbs, trunk and throat. He observed widespread twitching and perceived some weakness in his arms and legs. Neurological examination revealed dysarthria, fasciculations, and weakness in his tongue. Fasciculations were also present in his arms and legs and his reflexes were symmetrically high. His hands also showed atrophy and weakness. Serum creatine kinase activity was 168 U/L. Patient B was diagnosed with probable ALS and died 26 months after his first symptoms. Both his parents were deceased and their DNA was not available for testing.

Patient C, presented with stiffness in her left leg at 58 years of age. Several weeks later she experienced clumsiness of her left arm and twitching in her muscles. Her family history did not reveal any neurological disorders. Neurological examination demonstrated fasciculations, muscle weakness and high reflexes in her arms and legs. Serum creatine kinase activity was 196 U/L. Nine months after diagnosis she was wheelchair-bound, experienced severe weakness in her arms and had developed speech difficulties. She died roughly one year later. Her parents' DNA was not available for testing.

## Supplementary References

- (1) Maruyama H, Morino H, Ito H et al. Mutations of optineurin in amyotrophic lateral sclerosis. *Nature* 2010;465:223-226.
- (2) Iida A, Hosono N, Sano M et al. Optineurin mutations in Japanese amyotrophic lateral sclerosis. *J Neurol Neurosurg Psychiatry* 2012;83:233-235.
- (3) Belzil VV, Daoud H, Desjarlais A et al. Analysis of OPTN as a causative gene for amyotrophic lateral sclerosis. *Neurobiol Aging* 2011;32:555.e13-e14.
- (4) Millicamps S, Boillee S, Chabrol E et al. Screening of OPTN in French familial amyotrophic lateral sclerosis. *Neurobiol Aging* 2011;32:557.e11-e13.

# 5

**“All the things that exist are objects either of perception or of thought, and knowledge is in a way the things that are known, perception in a way the things that are perceived.”**

Aristotle, On the Soul.



# **VCP mutations in familial and sporadic amyotrophic lateral sclerosis**

Max Koppers, Marka van Blitterswijk, Lotte Vlam, Paulina A. Rowicka,  
Paul W.J. van Vught, Ewout J.N. Groen, Wim G.M. Spliet, Jooyeon Engelen-Lee,  
Helenius J. Schelhaas, Marianne de Visser, Anneke J. van der Kooi,  
W.-Ludo van der Pol, R.-Jeroen Pasterkamp, Jan H. Veldink\*,  
Leonard H. van den Berg\*

\* Contributed equally to this work.

## Abstract

Mutations in the *VCP* gene were recently reported to cause 1-2% of the familial amyotrophic lateral sclerosis (ALS) cases. *VCP* mutations are already known to cause inclusion body myopathy (IBM) with Paget's disease (PDB) and frontotemporal dementia (FTD). The presence of *VCP* mutations in patients with sporadic ALS, sporadic ALS-FTD and progressive muscular atrophy (PMA), a known clinical mimic of IBM, is not known. To determine the identity and frequency of *VCP* mutations we screened a cohort of 93 familial ALS, 754 sporadic ALS, 58 sporadic ALS-FTD, and 264 PMA patients for mutations in the *VCP* gene. Two non-synonymous mutations were detected; one known mutation (p.R159H) in a patient with familial ALS with several family members suffering from FTD, and one mutation (p.I114V) in a patient with sporadic ALS. Conservation analysis and protein prediction software indicate the p.I114V mutation to be a rare benign polymorphism. Thus, *VCP* mutations are a rare cause of familial ALS. The role of *VCP* mutations in sporadic ALS, if present, appears limited.

## Introduction

Amyotrophic lateral sclerosis (ALS) is a progressive adult-onset neurodegenerative disease that affects upper and lower motor neurons. This will eventually cause death mostly due to respiratory failure within three to five years after disease onset. ALS is familial (FALS) in 5% of cases with a Mendelian pattern of inheritance, while the remaining 95% are considered to be sporadic ALS (SALS) cases. Several genes have been linked to FALS, including superoxide dismutase-1 (*SOD1*), TAR DNA-binding protein (*TARDBP*), fused in sarcoma / translated in liposarcoma (*FUS/TLS*), optineurin (*OPTN*), and vesicle-associated membrane protein B (*VAPB*) with variable frequencies depending on the geographical location of the investigated patient samples.<sup>1-5</sup>

There is a recognized clinical and pathological overlap between ALS and frontotemporal dementia (FTD). Mild cognitive abnormalities indicative of frontal lobe involvement can be found in up to 50% of ALS patients.<sup>6</sup> In addition, in approximately 5% of ALS patients, FTD is present with marked behavioral changes and language impairment.<sup>7-9</sup> Finally, several families have been identified with individuals diagnosed with ALS, FTD or both, and ALS and FTD are both characterized by TDP-43-positive, ubiquitinated cytoplasmatic inclusions.<sup>10-12</sup>

In a recent study, mutations in the valosin-containing protein gene (*VCP*) were identified in five ALS families by whole exome sequencing.<sup>13</sup> *VCP* mutations are known to cause inclusion body myopathy (IBM) with Paget's disease of bone (PDB) and FTD (IBMPFD).<sup>14</sup> IBMPFD is an autosomal dominant multisystem degenerative disease, primarily affecting muscle, brain and bone tissue. Interestingly, just as in ALS and FTD, IBMPFD is characterized by TDP-43-positive, ubiquitinated inclusions in muscle and frontal cortex neurons.<sup>15;16</sup>

It is not known whether *VCP* mutations are present in other populations, large samples of SALS patients, or families where (sporadic) ALS and FTD co-occur (SALS-FTD). To determine the frequency of *VCP* mutations in the Dutch population, we screened 93 FALS patients and a large cohort of SALS and SALS-FTD patients for mutations in the *VCP* gene. In addition, we included patients with progressive muscular atrophy (PMA), since PMA is a known clinical mimic of IBM.<sup>17</sup>

## Methods

### Human subjects

DNA samples were collected as part of a population-based study in The Netherlands (Prospective ALS study in The Netherlands (PAN)).<sup>18</sup> Patients were diagnosed with ALS according to the revised El Escorial criteria.<sup>19</sup> A total of 93 FALS patients from 80 unrelated families were included in this study. In addition, 754 SALS patients, 264 PMA patients and 58 SALS-FTD patients were included. Patients were already screened for mutations in *SOD1*, *VAPB*, *TARDBP*, *FUS/TLS*, and angiogenin (*ANG*). The control population consisted of 713 healthy Dutch individuals with negative medical and family histories for neurological disease; all were of Dutch descent.

Patient material was obtained with approval of the Institutional Review Board, and all participants gave informed consent.

### Genetic analysis

Venous blood samples were drawn using 10 ml EDTA tubes and genomic DNA was extracted from whole blood using standard procedures. DNA was whole genome amplified using a Qiagen Repli-g Mini kit according to manufacturer's instructions using 50 ng of input genomic DNA per reaction.

PCR for the coding sequence of *VCP* was performed using a touchdown thermocycling program (94°C for sixty seconds; fifteen cycles of 94°C for twenty seconds, 65°C for thirty seconds with a decrement of 0.5°C per cycle, 72°C for sixty seconds; followed by thirty cycles of 94°C for twenty seconds, 57°C for thirty seconds and 72°C for sixty seconds; 72°C for three minutes). PCR reactions consisted of 5 µL amplified DNA (5 ng/µL), 0.2 µM of each primer, 200 µM of each dinucleotide triphosphate (dNTP), 25 mM Tricine, 7.0% glycerol (w/v), 1.6% dimethyl sulfoxide (DMSO, w/v), 2 mM MgCl<sub>2</sub>, 85 mM ammonium acetate pH 8.7 and 0.04 U Taq Polymerase in a total volume of 10 µL. Primers were designed using Primer 3.0 (<http://frodo.wi.mit.edu/primer3/>) and sequences are listed in Table 5.1. PCR products were checked on a 1.2% agarose gel and diluted in 25 µL H<sub>2</sub>O; 1 µL was directly used as template for the sequencing reactions. Sequencing reactions, containing 0.1 µL BigDye (v3.1; Applied Biosystems, Foster City, CA, USA), 1.99 µL 2.5× dilution buffer and 0.4 µM of the same primer used in the PCR reaction (either forward or reverse) in a total volume of 5 µL, were performed using cycling conditions as follows: forty cycles of 94°C for ten seconds, 50°C for five seconds and 60°C for two minutes. Sequencing products were purified by ethanol precipitation in the presence of 40 mM sodium-acetate and analyzed on a 96-capillary 3730XL DNA analyzer (Applied

**Table 5.1** Primers used to sequence coding region of the *VCP* gene

| Exon             | Forward               | Reverse                  |
|------------------|-----------------------|--------------------------|
| 1 <sup>a</sup>   | GAGAATCCAATCCGTCGAG   | TCCTGGTCTCCACCTCTCTG     |
| 2_3 <sup>a</sup> | GCTTTCTGGTCTAGGGACAGC | CAAGAACTTGGTCTGCCTG      |
| 4                | AAGCCATCCTGCCTTTTCTT  | AATAAATACAGGGGAAAAGCATAA |
| 5                | TGACACCTCTAACTGTGCTTG | GTTACCACATGATGCCACAC     |
| 6                | TATTCTTGCCTTCTCCTTTC  | TTGGCACCACCTTAGACTTG     |
| 7                | AGGTGGGAACCTAATCACAC  | CAGCTCATAAGCCCAGTTC      |
| 8_9              | GGCCAAACAAGCAAGATAAC  | GGCTTCAAGAGGATTAGGTG     |
| 10 <sup>a</sup>  | AGGCCTGTCTCTTACCTCTG  | AGACACTGTAACGCCTGGTC     |
| 11_12            | CTATTGTCTCTGAGCCTCCTG | AAATGTGTTGACACCCTGAG     |
| 13               | ATGTGGAGGTAGCCTTGAAC  | AAACAGCCTCTATTCTTGG      |
| 14               | CACGTTTGCCTAGAGACATC  | ATGCAAGTCTCCCACAGC       |
| 15               | TCGAGAGGAGAGGCTAAATG  | CTGGCTCTCCATGATTGG       |
| 16_17            | CTTACCTCAGGTTGGATTGG  | TGGCAGTAGTGCCTTGGTTC     |

<sup>a</sup> Long-range PCR enzyme (Fermentas) was used for the amplification of these amplicons.

Biosystems), using the standard RapidSeq protocol on 36 cm array.<sup>20</sup> Sequences were analyzed for the presence of mutations using PolyPhred and in-house developed software. All mutations were verified by independent PCR and sequence reactions on genomic DNA.

### Bioinformatic analysis

The potential consequence of the identified missense mutations was analyzed using the bioinformatics programs PMut (<http://mmb2.pcb.ub.es:8080/PMut/>) and SNAP (<http://cubic.bioc.columbia.edu/services/SNAP/>). Conservation analysis of the altered amino acids was carried out using ClustalW2 (<http://www.ebi.ac.uk/Tools/msa/clustalw2/>).

## Results

To determine the frequency of *VCP* mutations in ALS patients in The Netherlands, we sequenced all coding exons of the *VCP* gene in 93 FALS, 377 SALS, 58 SALS-FTD, and 264 PMA patients as well as 695 healthy controls. Exon four and exon five were sequenced

**Table 5.2** Non-synonymous and synonymous variants detected in the VCP gene in this study

| Exon | Variant | PMut prediction | SNAP prediction | FALS (n = 93) | SALS  | PMA   | SALS-FTD | Controls |
|------|---------|-----------------|-----------------|---------------|-------|-------|----------|----------|
| 4    | p.I114V | Neutral         | Neutral         | 0/80          | 1/754 | 0/264 | 0/58     | 0/695    |
| 5    | p.R159H | Pathological    | Non-neutral     | 1/80          | 0/754 | 0/264 | 0/58     | 0/713    |

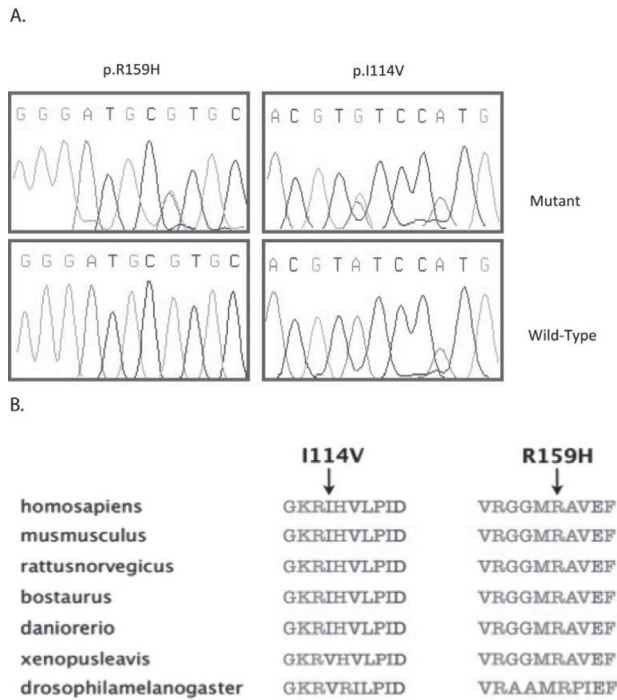
  

| Exon | Variant | FALS (n = 93) | SALS  | PMA   | SALS-FTD | Controls |
|------|---------|---------------|-------|-------|----------|----------|
| 9    | p.T330T | 0/80          | 0/377 | 0/264 | 1/58     | 0/685    |
| 11   | p.L414L | 0/80          | 1/377 | 1/264 | 0/58     | 0/674    |
| 12   | p.I479I | 1/80          | 0/377 | 0/264 | 0/58     | 0/674    |
| 13   | p.A528A | 0/80          | 2/377 | 0/264 | 0/58     | 5/662    |
| 14   | p.L661L | 0/80          | 1/377 | 0/264 | 0/58     | 0/594    |
| 17   | p.D802D | 0/80          | 1/377 | 0/264 | 0/58     | 0/646    |

Abbreviations: FALS = familial amyotrophic lateral sclerosis, SALS = sporadic amyotrophic lateral sclerosis, PMA= progressive muscular atrophy, FTD = frontotemporal dementia, and n = number.

in 377 additional SALS patients. One previously identified non-synonymous mutation and one novel non-synonymous variant were identified (Table 5.2).

We detected a p.R159H mutation in one FALS patient (patient A) which was not present in any of the 713 control subjects sequenced. To further investigate the pathogenicity of this mutation, we also tested the unaffected brother of the patient and did not find the mutation. DNA of other family members was not available. We also identified a novel non-synonymous variant mutation (p.I114V) in one SALS patient (patient B) which was absent in 695 control subjects. Suggestive evidence that this amino acid change is a rare neutral polymorphism is found when performing conservation analysis of the amino acid amongst species and *in silico* protein prediction (Figure 5.1). No non-synonymous mutations were detected in PMA and SALS-FTD patients. In addition to these two non-synonymous mutations, several synonymous changes were detected. A total of six synonymous changes were detected in five SALS, one SALS-FTD, one FALS, and one PMA patient (Table 5.2). Interestingly, five of these synonymous mutations were not found in our control samples. Overall, there was no significant enrichment of non-synonymous mutations in ALS versus controls (p-value 0.18, Fisher's exact test).



**Figure 5.1** A. Chromatograms of wild-type and mutant alleles found in one FALS (p.R159H) and one SALS (p.I114V) patient. B. Conservation analysis of the mutated amino acids amongst several species using ClustalW2 (<http://www.ebi.ac.uk/Tools/msa/clustalw2/>). See Appendix page 381 for Figure 5.1 in color.

### Clinical information

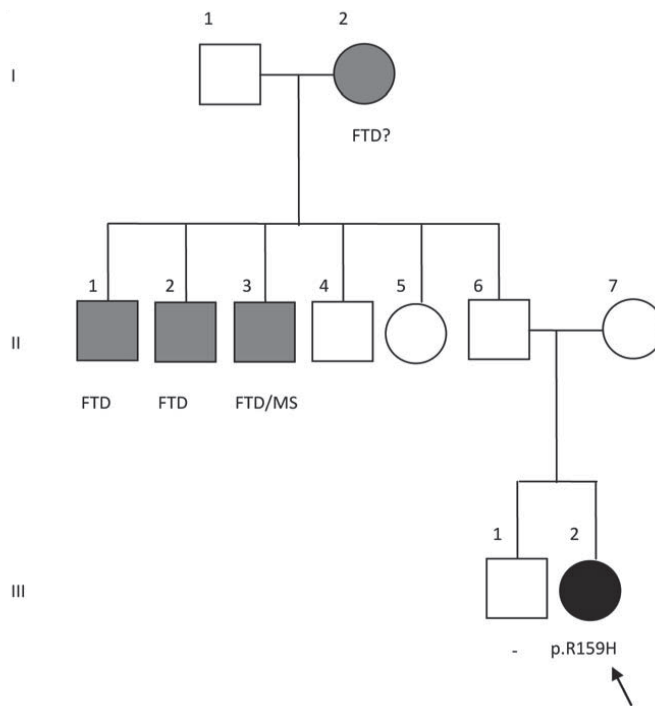
Patient A gradually developed weakness in her hands (Table 5.3). Within a year after onset of symptoms, she also noticed weakness in her left leg. Neurological examination demonstrated muscle atrophy in her left arm and both hands, fasciculations in her left arm, and weakness in proximal arm- and leg muscles. Reflexes in arms and legs were brisk. She was diagnosed with ALS and died approximately two years after the onset of symptoms. Autopsy of brain and spinal cord were consistent with classical ALS, characterized by p62-, ubiquitin- and TDP-43-positive inclusions. In the granular layer of the hippocampus and in the neocortex of the frontal and temporal lobe, a few p62- and ubiquitin-positive inclusions were found; this can be seen more extensively in ALS-FTD cases.

**Table 5.3** Clinical information on SALS and FALS with VCP variants

|      | Patient | Variant | Gender | El Escorial criteria | Age at onset (y) | Site of onset | Duration (m)     |
|------|---------|---------|--------|----------------------|------------------|---------------|------------------|
| FALS | A       | p.R159H | F      | Possible             | 59               | Cervical      | 23 <sup>b</sup>  |
| SALS | B       | p.I114V | F      | Possible             | 52               | Lumbosacral   | 119 <sup>a</sup> |

Abbreviations: F = female, y = years, and m = months. Patients are either alive<sup>a</sup>, or deceased<sup>b</sup>.

The family history of patient A is shown in Figure 5.2. Three of her father’s brothers were diagnosed with FTD (II:1, II:2, II:3), one of them was also diagnosed with multiple sclerosis (MS) (II:3). Her father (II:6) died due to a car accident at 31 years of age. The grandmother of patient A (father’s side) was not formally diagnosed with FTD, but she exhibited signs of dementia combined with behavioral changes. There were no other family members with neurodegenerative diseases.



**Figure 5.2** Pedigree of FALS patient with p.R159H mutation. Screened individuals that did not have a VCP mutation are marked with '-'.  
 - p.R159H



Patient B experienced weakness in her legs, stumbling, and difficulties with running (Table 5.2). She also developed weakness in her arms, and noticed twitching in both her arms and legs. Neurological examination showed brisk reflexes in arms and legs. She was diagnosed with SALS, since her family history did not reveal other family members with ALS. Her symptoms gradually progressed and currently, almost ten years later, she is unable to walk, has severe weakness in her arms, and has developed difficulties with talking and breathing. Her mother died at 82 years of age due to cancer; her father died at 93 years of age (he had developed dementia, without behavioral changes).

## Discussion

In the present study, we screened a large cohort of patients diagnosed with FALS, SALS, SALS-FTD and PMA for mutations in the *VCP* gene. We report a p.R159H mutation in a FALS patient from a family in which members were diagnosed with FTD. In addition we identified a novel p.I114V variant in one SALS patient which was not present in 695 control subjects. In a previous study, no mutations in the *VCP* gene were identified in 73 SALS patients screened.<sup>13</sup> We could not detect *VCP* mutations in ALS patients associated with FTD or in patients with only lower motor neuron signs.

Mutations in the *VCP* gene, located on chromosome 9p13.3, have been reported in IBMPFD, a multi-system degenerative disease affecting brain, bone and muscle tissue. Recently, a whole exome sequencing study identified mutations in the *VCP* gene to be the cause of ALS in an Italian family. They identified *VCP* mutations in an additional four ALS families from the United States and Italy.<sup>13</sup> The p.R159H mutation that was identified in one of our FALS cases has previously been identified in four unrelated IBMPFD families.<sup>21-23</sup> These families show clinical heterogeneity between and even within families with a clinical presentation in patients of FTD, IBM, PDB or a combination of these diseases. In one family from the United States a mutation at the same amino acid (p.R159G) was identified in the recent whole exome sequencing study.<sup>13</sup> Members from this family presented with ALS, ALS-FTD or ALS with Paget's disease. Furthermore, a p.R159C mutation has been reported in a patient with IBM and FTD.<sup>24</sup>

In the other ALS families in which *VCP* mutations were identified, individuals within the same family presented with different diseases. The presence of ALS and FTD in individuals from the family in which a *VCP* mutation was identified here is consistent with these findings.

Thus, mutations in *VCP* seem to lead to a range of clinical presentations, even within the same family. This observation supports the idea that ALS, FTD and PDB have an overlapping pathological mechanism. This overlap is already recognized for ALS and FTD as evidenced by TDP-43-positive, ubiquitinated cytoplasmic inclusions found in both patients.<sup>11</sup> An overlap between ALS and PDB is suggested by a recent genome-wide association study (GWAS) where an association was found between the *OPTN* gene, in which mutations have been identified in ALS, and PDB.<sup>4;25;26</sup>

The pathogenicity of the novel p.I114V variant identified here in a SALS patient is unknown. Conservation analysis and protein prediction software do not indicate this mutation to be pathogenic but rather to be a rare benign polymorphism. It is interesting, however, to note that a mutation in the same exon (p.P137L) has previously been found in one IBMPFD case.<sup>22</sup> Functional studies are needed to determine the pathogenicity of this variant.

An important pathological feature of ALS is the presence of TDP-43-positive, ubiquitinated cytoplasmic inclusions.<sup>11</sup> It has been shown that mutations in the *VCP* gene lead to TDP-43-positive, ubiquitinated cytoplasmic inclusions in muscle and frontal cortex neurons of patients.<sup>14;16</sup> Moreover, transgenic mice harboring the p.R155H or p.A232E mutation in *VCP* contain TDP-43-positive inclusions and recapitulate the brain, bone, and muscle pathology of IBMPFD.<sup>27-29</sup>

In summary, based on our data, the frequency of *VCP* mutations in FALS is ~1-2%, the same frequency found in the whole exome sequencing study by Johnson et al. (2010).<sup>13</sup> This study indicates that it is uncertain whether there are *VCP* mutations in SALS, and, if present, they are extremely rare. We could not identify a higher frequency of mutations in specific subpopulations of patients with ALS associated with FTD or of patients with only lower motor neuron signs. Additional cohorts of FALS and SALS patients will have to be screened to determine the frequency of *VCP* mutations in other populations.

## Acknowledgements

We would like to thank all patients and healthy volunteers who participated in this project as well as the study staff, general practitioners and pharmacists. This work has received funding from the European Community's Health Seventh Framework Program (FP7/2007-2013) under grant agreement n° 259867, VSB fonds, EURO-MOTOR FP7, The Netherlands ALS Foundation (J.H.V. and L.H.v.d.B.), Neuroscience and Cognition Utrecht (NCU), the Prinses Beatrix Fonds (Kersten Foundation) and the Adessium Foundation (R.J.P., J.H.V. and L.H.v.d.B.). J.H.V. is supported by the Brain Foundation of The Netherlands and J.H.V., R.J.P., and M.K. are supported by the Thierry Latran Foundation.

## References

- (1) Groen EJ, van Es MA, van Vught PW et al. FUS mutations in familial amyotrophic lateral sclerosis in the Netherlands. *Arch Neurol* 2010;67:224-230.
- (2) Nishimura AL, Mitne-Neto M, Silva HC et al. A mutation in the vesicle-trafficking protein VAPB causes late-onset spinal muscular atrophy and amyotrophic lateral sclerosis. *Am J Hum Genet* 2004;75:822-831.
- (3) Sreedharan J, Blair IP, Tripathi VB et al. TDP-43 mutations in familial and sporadic amyotrophic lateral sclerosis. *Science* 2008;319:1668-1672.
- (4) van Blitterswijk M, van Vught PW, van Es MA et al. Novel optineurin mutations in sporadic amyotrophic lateral sclerosis patients. *Neurobiol Aging* 2011 Jul 27.
- (5) van Es MA, Dahlberg C, Birve A, Veldink JH, van den Berg LH, Andersen PM. Large-scale SOD1 mutation screening provides evidence for genetic heterogeneity in amyotrophic lateral sclerosis. *J Neurol Neurosurg Psychiatry* 2010;81:562-566.
- (6) Elamin M, Phukan J, Bede P et al. Executive dysfunction is a negative prognostic indicator in patients with ALS without dementia. *Neurology* 2011;76:1263-1269.
- (7) Murphy JM, Henry RG, Langmore S, Kramer JH, Miller BL, Lomen-Hoerth C. Continuum of frontal lobe impairment in amyotrophic lateral sclerosis. *Arch Neurol* 2007;64:530-534.
- (8) Phukan J, Pender NP, Hardiman O. Cognitive impairment in amyotrophic lateral sclerosis. *Lancet Neurol* 2007;6:994-1003.
- (9) Ringholz GM, Appel SH, Bradshaw M, Cooke NA, Mosnik DM, Schulz PE. Prevalence and patterns of cognitive impairment in sporadic ALS. *Neurology* 2005;65:586-590.
- (10) Morita M, Al-Chalabi A, Andersen PM et al. A locus on chromosome 9p confers susceptibility to ALS and frontotemporal dementia. *Neurology* 2006;66:839-844.
- (11) Neumann M, Sampathu DM, Kwong LK et al. Ubiquitinated TDP-43 in frontotemporal lobar degeneration and amyotrophic lateral sclerosis. *Science* 2006;314:130-133.
- (12) Vance C, Al-Chalabi A, Ruddy D et al. Familial amyotrophic lateral sclerosis with frontotemporal dementia is linked to a locus on chromosome 9p13.2-21.3. *Brain* 2006;129:868-876.
- (13) Johnson JO, Mandrioli J, Benatar M et al. Exome sequencing reveals VCP mutations as a cause of familial ALS. *Neuron* 2010;68:857-864.
- (14) Watts GD, Wymer J, Kovach MJ et al. Inclusion body myopathy associated with Paget disease of bone and frontotemporal dementia is caused by mutant valosin-containing protein. *Nat Genet* 2004;36:377-381.
- (15) Neumann M, Kwong LK, Sampathu DM, Trojanowski JQ, Lee VM. TDP-43 proteinopathy in frontotemporal lobar degeneration and amyotrophic lateral sclerosis: protein misfolding diseases without amyloidosis. *Arch Neurol* 2007;64:1388-1394.

- (16) Wehl CC, Temiz P, Miller SE et al. TDP-43 accumulation in inclusion body myopathy muscle suggests a common pathogenic mechanism with frontotemporal dementia. *J Neurol Neurosurg Psychiatry* 2008;79:1186-1189.
- (17) Dabby R, Lange DJ, Trojaborg W et al. Inclusion body myositis mimicking motor neuron disease. *Arch Neurol* 2001;58:1253-1256.
- (18) Huisman MH, de Jong SW, van Doormaal PT et al. Population based epidemiology of amyotrophic lateral sclerosis using capture-recapture methodology. *J Neurol Neurosurg Psychiatry* 2011;82:1165-1170.
- (19) Brooks BR, Miller RG, Swash M, Munsat TL. El Escorial revisited: revised criteria for the diagnosis of amyotrophic lateral sclerosis. *Amyotroph Lateral Scler Other Motor Neuron Disord* 2000;1:293-299.
- (20) van Boxtel R, Toonen PW, Verheul M et al. Improved generation of rat gene knockouts by target-selected mutagenesis in mismatch repair-deficient animals. *BMC Genomics* 2008;9:460.
- (21) Haubenberger D, Bittner RE, Rauch-Shorny S et al. Inclusion body myopathy and Paget disease is linked to a novel mutation in the VCP gene. *Neurology* 2005;65:1304-1305.
- (22) Stojkovic T, Hammouda el H, Richard P et al. Clinical outcome in 19 French and Spanish patients with valosin-containing protein myopathy associated with Paget's disease of bone and frontotemporal dementia. *Neuromuscul Disord* 2009;19:316-323.
- (23) van der Zee J, Pirici D, Van Langenhove T et al. Clinical heterogeneity in 3 unrelated families linked to VCP p.Arg159His. *Neurology* 2009;73:626-632.
- (24) Bersano A, Del Bo R, Lamperti C et al. Inclusion body myopathy and frontotemporal dementia caused by a novel VCP mutation. *Neurobiol Aging* 2009;30:752-758.
- (25) Albagha OM, Visconti MR, Alonso N et al. Genome-wide association study identifies variants at CSF1, OPTN and TNFRSF11A as genetic risk factors for Paget's disease of bone. *Nat Genet* 2010;42:520-524.
- (26) Maruyama H, Morino H, Ito H et al. Mutations of optineurin in amyotrophic lateral sclerosis. *Nature* 2010;465:223-226.
- (27) Badadani M, Nalbandian A, Watts GD et al. VCP associated inclusion body myopathy and paget disease of bone knock-in mouse model exhibits tissue pathology typical of human disease. *PLoS One* 2010;5.
- (28) Custer SK, Neumann M, Lu H, Wright AC, Taylor JP. Transgenic mice expressing mutant forms VCP/p97 recapitulate the full spectrum of IBMPFD including degeneration in muscle, brain and bone. *Hum Mol Genet* 2010;19:1741-1755.
- (29) Wehl CC, Miller SE, Hanson PI, Pestronk A. Transgenic expression of inclusion body myopathy associated mutant p97/VCP causes weakness and ubiquitinated protein inclusions in mice. *Hum Mol Genet* 2007;16:919-928.

# 5

# 6

**“No one discovers what is false, nor can something that remains unclear be a discovery.”**

Cicero, On Academic Scepticism.

# ***UBQLN2* in familial amyotrophic lateral sclerosis in The Netherlands**

Perry T.C. van Doormaal, Wouter van Rheenen, Marka van Blitterswijk,  
Raymond D. Schellevis, Helenius J. Schelhaas, Marianne de Visser,  
Anneke J. van der Kooi, Jan H. Veldink\*, Leonard H. van den Berg\*

\* Contributed equally to this work.

*Neurobiol Aging*. In press.

## Abstract

Recently, it was discovered that mutations in the ubiquilin-2 (*UBQLN2*) gene were a cause of an X-linked dominant type of familial amyotrophic lateral sclerosis (ALS). We investigated the frequency of mutations in this gene in a cohort of 92 families with ALS in The Netherlands. Eight families were excluded because of male-to-male transmission. In the remaining 84 familial ALS cases no mutations were discovered in *UBQLN2*. Hence, *UBQLN2* was not found to be a cause of familial ALS in The Netherlands.



## Introduction

Amyotrophic lateral sclerosis (ALS) is a neurodegenerative disease with involvement of both upper and lower motor neurons, resulting in progressive weakness and an average lifespan of three years after disease onset.<sup>1</sup> In 5-10% of the cases, ALS is of familial origin, with at least one close relative that is also diagnosed with the disease.<sup>2,3</sup> A number of genes have been reported to be causal for familial ALS, from superoxide dismutase-1 (*SOD1*) in 1993<sup>4</sup> to chromosome 9 open reading frame 72 (*C9orf72*) repeat expansions and ubiquilin-2 (*UBQLN2*) mutations in 2011.<sup>5-7</sup> The latter gene, located on the X-chromosome, encodes the ubiquitin-like protein ubiquilin-2, which functions in the ubiquitinated protein degradation pathway. A previous study discovered five different mutations in *UBQLN2* in five families out of 189 probands from families of non male-to-male transmitted familial ALS. In familial ALS, sporadic ALS and ALS with frontotemporal dementia (FTD) ubiquilin pathology was found in spinal and brain tissue. In France, one mutation was found in the *UBQLN2* gene in a cohort of 130 familial ALS patients.<sup>8</sup> This mutation did not segregate with the disease, and thus, did not seem to be pathogenic. No other mutations in *UBQLN2* were found in this French cohort.

We analyzed a cohort of familial ALS cases to determine the frequency of *UBQLN2* mutations in The Netherlands.

## Methods

The study population consisted of probands from 92 different ALS families in The Netherlands. In 22 of these families, ALS was associated with FTD. Genomic DNA was extracted from whole blood using standard procedures. PCR of the complete *UBQLN2* gene, including 125 base pairs of the 5'UTR and 293 base pairs of the 3'UTR, was performed on 100 ng genomic DNA with primers, as reported previously.<sup>7</sup> BigDye Terminator 3.1 sequencing kit (Applied Biosystems, Foster City, California, USA), DNA Analyzer 3730XL and PolyPhred software<sup>9</sup> were used for sequencing and data analysis (see Supplement for more information).

## Results

Probands of 92 families with ALS were available for genetic analysis. Because *UBQLN2* mediated ALS is an X-linked dominantly inherited disease, eight families with male-to-male inheritance were excluded. In the remaining 84 families, the complete *UBQLN2* gene was sequenced. No mutations were found in any of these patients.

## Discussion

*UBQLN2* mutations were not identified in the 84 Dutch ALS families with possible X-linked inheritance. Based on this study, the contribution of mutations in *UBQLN2* to the total spectrum of familial ALS seems small.

In the initial report on *UBQLN2*, mutations were scarce: only five out of 189 probands (2.6%) without male-to-male transmission had mutations in this gene.<sup>7</sup> Importantly, ubiquilin-2 pathology was shown in the spinal cords of ALS cases and in the brains of ALS/dementia cases with or without *UBQLN2* mutations, thus indicating a role for defects in the protein degradation pathway in ALS. A recent study in France, however, is well in line with our study: no causal mutations in *UBQLN2* were found in French ALS families.<sup>8</sup>

The frequency of specific gene mutations has already been shown to differ significantly between countries, for instance, *SOD1* mutations are a rare cause of ALS in The Netherlands, but account for 23.5% of the familial cases in Scandinavia and in the United States.<sup>10,11</sup> We demonstrate that the prevalence of *UBQLN2* mutations also differs between countries.

To conclude, *UBQLN2* mutations are not a cause of familial ALS in The Netherlands. Further studies are required to determine differences between populations.

## Acknowledgements

J.H.V. is funded by the Thierry Latran Foundation. The research leading to these results has received funding from the European Community's Health Seventh Framework Program (FP7/2007-2013) (grant agreement n° 259867).

## References

- (1) Mitchell JD, Borasio GD. Amyotrophic lateral sclerosis. *Lancet* 2007;369:2031-2041.
- (2) Byrne S, Walsh C, Lynch C et al. Rate of familial amyotrophic lateral sclerosis: a systematic review and meta-analysis. *J Neurol Neurosurg Psychiatry* 2011;82:623-627.
- (3) Valdmanis PN, Rouleau GA. Genetics of familial amyotrophic lateral sclerosis. *Neurology* 2008;70:144-152.
- (4) Rosen DR, Siddique T, Patterson D et al. Mutations in Cu/Zn superoxide dismutase gene are associated with familial amyotrophic lateral sclerosis. *Nature* 1993;362:59-62.
- (5) DeJesus-Hernandez M, Mackenzie IR, Boeve BF et al. Expanded GGGGCC Hexanucleotide Repeat in Noncoding Region of C9ORF72 Causes Chromosome 9p-Linked FTD and ALS. *Neuron* 2011;72:245-256.
- (6) Renton AE, Majounie E, Waite A et al. A Hexanucleotide Repeat Expansion in C9ORF72 Is the Cause of Chromosome 9p21-Linked ALS-FTD. *Neuron* 2011;72:257-268.
- (7) Deng HX, Chen W, Hong ST et al. Mutations in UBQLN2 cause dominant X-linked juvenile and adult-onset ALS and ALS/dementia. *Nature* 2011;477:211-215.
- (8) Millicamps S, Corcia P, Cazeneuve C et al. Mutations in UBQLN2 are rare in French amyotrophic lateral sclerosis. *Neurobiol Aging* 2012;33:839.e1-e3.
- (9) Nickerson DA, Tobe VO, Taylor SL. PolyPhred: automating the detection and genotyping of single nucleotide substitutions using fluorescence-based resequencing. *Nucleic Acids Res* 1997;25:2745-2751.
- (10) Andersen PM, Nilsson P, Keranen ML et al. Phenotypic heterogeneity in motor neuron disease patients with CuZn-superoxide dismutase mutations in Scandinavia. *Brain* 1997;120 ( Pt 10):1723-1737.
- (11) Cudkovicz ME, Kenna-Yasek D, Sapp PE et al. Epidemiology of mutations in superoxide dismutase in amyotrophic lateral sclerosis. *Ann Neurol* 1997;41:210-221.

## SUPPLEMENT

### Supplementary Methods

The study population consisted of probands from 92 different ALS families in The Netherlands. Patients were diagnosed with ALS according to the El Escorial criteria at a national referral center for ALS: University Medical Center Utrecht, Academic Medical Center in Amsterdam or Radboud University Medical Center in Nijmegen. Patients were diagnosed with familial ALS when one of the first- or second-degree relatives was also diagnosed with the disease. In 22 of these families, ALS was associated with FTD in patients or relatives. Patients were previously screened for mutations in superoxide dismutase-1 (*SOD1*), fused in sarcoma / translated in liposarcoma (*FUS/TLS*), angiogenin (*ANG*), TAR DNA-binding protein (*TARDBP*), vesicle-associated membrane protein B (*VAPB*), valosin-containing protein (*VCP*), optineurin (*OPTN*), and chromosome 9 open reading frame 72 (*C9orf72*). Written informed consent was obtained from all individuals, and the study was approved by the local ethical committee.

Genomic DNA was extracted from whole blood using standard procedures. PCR of the complete *UBQLN2* gene was performed on 100 ng genomic DNA with primers, as reported previously.<sup>1</sup> These primers divided *UBQLN2* in five overlapping amplicons, including 125 base pairs of the 5'UTR and 293 base pairs of the 3'UTR. The protocol for the second amplicon consisted of the following steps: incubation at 96°C (two minutes), 35 cycles of 96°C (thirty seconds), 57°C (45 seconds) and 72°C (one minute), and extension for five minutes at 72°C. For the other four amplicons the protocol consisted of incubation at 95°C (two minutes), 35 cycles of 95°C (thirty seconds), 55°C (45 seconds) and 72°C (one minute), and extension for five minutes at 72°C. BigDye Terminator 3.1 sequencing kit (Applied Biosystems), DNA Analyzer 3730XL and PolyPhred software<sup>2</sup> were used for sequencing and data analysis.

### Supplementary References

- (1) Deng HX, Chen W, Hong ST et al. Mutations in *UBQLN2* cause dominant X-linked juvenile and adult-onset ALS and ALS/dementia. *Nature* 2011;477:211-215.
- (2) Nickerson DA, Tobe VO, Taylor SL. PolyPhred: automating the detection and genotyping of single nucleotide substitutions using fluorescence-based resequencing. *Nucleic Acids Res* 1997;25:2745-2751.

# 6

# 7

**“Al wie kennis loochent, ontkent ook die kennis, aangezien hij toegeeft niets te kennen.”**

Lucretius, De Natuur van de Dingen.

## Expanded *ATXN2* CAG repeat size in ALS identifies genetic overlap between ALS and SCA2

Philip van Damme\*, Jan H. Veldink\*, Marka van Blitterswijk\*, Anniek Corveleyn, Paul W.J. van Vught, Vincent N. Thijs, Bénédicte Dubois, Gert Matthijs, Leonard H. van den Berg#, Wim Robberecht#

\* # Contributed equally to this work.

## Abstract

**Objectives:** Amyotrophic lateral sclerosis (ALS) is a neurodegenerative disorder of motor neurons that results in progressive muscle weakness and limits survival to two to five years after disease onset. Intermediate CAG repeat expansions in ataxin-2 (*ATXN2*), the causative gene of spinocerebellar ataxia type 2 (SCA2), have been implicated in sporadic ALS. We studied *ATXN2* in a large cohort of patients with sporadic and familial ALS.

**Methods:** We determined *ATXN2* CAG repeat size in 1,948 sporadic and familial ALS cases, and 2,002 controls from Belgium and The Netherlands.

**Results:** In controls, the maximal *ATXN2* repeat size was 31. In sporadic ALS, a significant amount of longer repeat sizes ( $\geq 32$ , range 32–39) were encountered (in 0.5% or 10/1,845 ALS cases, versus 0% in controls, p-value 0.0006). Receiver operating characteristic analysis showed that a cut-off of  $\geq 29$  appeared optimal to discriminate ALS from control (p-value 0.036, odds ratio [OR] 1.92, 95% confidence interval [CI] 1.04–3.64). A meta-analysis with the previously published results from the United States showed that the association between a repeat length of  $\geq 29$  and ALS became stronger (p-value  $< 0.0001$ , OR 2.93, 95% CI 1.73–4.98). In unexplained familial ALS, we found an intermediate repeat expansion of 31 and a homozygous repeat expansion of 33 each in 1.1% of families. The phenotype of patients with ALS with expanded repeat sizes ranged from rapidly progressive typical ALS to slowly progressive ALS with reduced sensory nerve action potentials.

**Conclusion:** Our data reveal a novel genetic overlap between ALS and SCA2.



## Introduction

Amyotrophic lateral sclerosis (ALS) is characterized by progressive motor neuron loss resulting in muscle weakness, wasting, fasciculations, spasticity, and hyperreflexia. Survival is limited to two to five years after disease onset. In 10% of cases, it is an inherited disorder. The most frequent disease-causing genes include superoxide dismutase-1 (*SOD1*),<sup>1</sup> TAR DNA-binding protein (*TARDBP*),<sup>2-4</sup> and fused in sarcoma / translated in liposarcoma (*FUS/TLS*).<sup>5,6</sup> In about 90% the family history is negative, but nevertheless, it is thought that there is a genetic component to this so-called sporadic ALS. In most patients with ALS, accumulations of the protein TDP-43 are encountered.<sup>7</sup> Animal models suggest that accumulation of wild-type and mutant TDP-43 is toxic to neurons.<sup>8-12</sup> In a recent study,<sup>13</sup> a genetic screen in yeast revealed ataxin-2 (*ATXN2*) as a modifier of TDP-43 toxicity. Intermediate-length *ATXN2* CAG repeats were found to be associated with sporadic ALS. *ATXN2* (chromosome 12q24) contains a CAG repeat in exon one, which encodes a polyglutamine tract. The size of this repeat is usually 22–23 in controls (normal range 14–31).<sup>14</sup> Heterozygous repeat lengths of  $\geq 34$  typically give rise to spinocerebellar ataxia type 2 (SCA2). Repeat lengths of 32–33 give rise to late-onset disease.<sup>15,16</sup> SCA2 is characterized by slowly progressive cerebellar ataxia and dysarthria with ocular findings (such as nystagmus and slow saccades).<sup>15-20</sup> In this study, *ATXN2* CAG repeat size was studied in a large cohort of patients with sporadic and familial ALS and controls from Belgium and The Netherlands.

## Methods

### Standard protocol approvals, registrations, and patient consents

This study was approved by the local ethical committee of the University of Leuven and Utrecht. Subjects participated in the study after written informed consent.

### Study population

A cohort of patients with sporadic ALS and controls followed at the neuromuscular clinic in Leuven, Belgium, and Utrecht, The Netherlands, between 1995 and 2010, was studied. All patients were diagnosed with ALS, fulfilling the revised El Escorial criteria. Blood was drawn and DNA was extracted from whole blood using standard methods. A total of 1,845 patients with sporadic ALS were studied (385 from Leuven and 1,460 from Utrecht). Samples from 2,002 neurologically normal individuals (435 from Leuven, 1,567 from Utrecht) were used as controls.

For familial ALS, 103 patients from 91 unexplained families, i.e., no *SOD1*, *FUS/TLS*, *TARDBP*, or angiogenin (*ANG*) mutations, were studied (25 families from Leuven and 66 from Utrecht).

### Determination of *ATXN2* CAG repeat size

The CAG repeat region of *ATXN2* was amplified using PCR. The forward primer used was 5' FAM-GGG CCC CTC ACC ATG TCG 3', the reverse primer 5' CGG GCT TGC GGA CAT TGG 3'. PCR cycling was as followed: four minutes 95°C, thirty cycles (twenty seconds 95°C, twenty seconds 55°C, 45 seconds 72°C), and five minutes 72°C. The CAG repeat length was determined after running on an ABI3130xl sequencer, using GeneMapper software version 4.0 (Applied Biosystems).

### Statistical analysis

Statistical analysis was performed in StatsDirect statistical software (version 2, 7, 8) and JMP 6.0.0. To determine the best cut-off to discriminate ALS cases from controls, a receiver operating characteristic analysis was performed. A two-tailed Fisher's exact test was used to calculate the significance for the genetic association of *ATXN2* repeat lengths and ALS. For the meta-analysis of *ATXN2* repeat lengths of samples from this study and the previously published study from the United States,<sup>13</sup> a Mantel-Haenszel test was used, to take potential heterogeneity between countries into account. The analysis of correlation of CAG repeat size and survival and age at onset was performed using a Cox proportional hazards model. For survival, we adjusted for age at onset, site of onset, country, and gender; for age at onset, we adjusted for gender, site of onset, and country. Repeat length differences according to site of onset were analyzed using logistic regression, adjusting for gender and country.

## Results

The CAG repeat size in exon one of *ATXN2* was determined in patients with ALS (n = 1,948) and controls (n = 2,002) from Belgium and The Netherlands. The characteristics of patients with ALS studied in this report are summarized in Table 7.1.

In controls, the repeat length was variable (range 16–31). A repeat length of 22 was most abundant (90.1% of control alleles), followed by a repeat length of 23 (6.1% of alleles) and 27 (1.7%). The maximum repeat size observed in controls was 31 (0.1% of alleles, encountered in the heterozygous state in 0.2% of controls). In a significant amount of

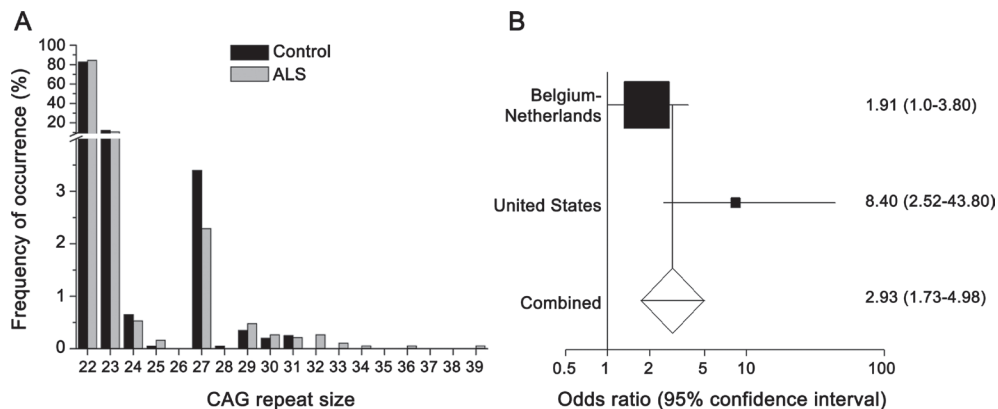
**Table 7.1** Characteristics of patients with ALS studied

|              | Number of patients | Age of onset (year $\pm$ SD) | Gender (% male) | Site of onset (% bulbar onset) | Diagnostic delay (months $\pm$ SD) | Survival (months $\pm$ SD) |
|--------------|--------------------|------------------------------|-----------------|--------------------------------|------------------------------------|----------------------------|
| Sporadic ALS | 1845               | 60.3 $\pm$ 12.0              | 59.5            | 30.1                           | 14.6 $\pm$ 18.8                    | 34.9 $\pm$ 24.9            |
| Familial ALS | 103                | 58.4 $\pm$ 10.3              | 51.5            | 26.2                           | 15.6 $\pm$ 17.6                    | 31.6 $\pm$ 20.3            |

Abbreviations: ALS = amyotrophic lateral sclerosis, and SD = standard deviation.

patients with ALS, heterozygous longer repeat sizes ( $\geq 32$ ) were identified (Figure 7.1A). In 10/1,845 sporadic patients (0.5%) and in 0/2,002 controls (0%), a repeat size of  $\geq 32$  was found ( $p$ -value 0.0006). In seven of those patients, we observed repeat lengths of 32–33; in three patients a repeat length of  $\geq 34$  was identified. The repeat size on the other allele was not associated with ALS, and was 22 (range 16–27) in 97.4 and 97.1% of controls and patients with ALS, respectively.

All patients with expanded *ATXN2* repeats had classic ALS, with a combination of upper and lower motor neuron signs, a disease onset of  $57.4 \pm 13.6$  years, and a survival after disease onset of  $35.2 \pm 15.6$  months (Table 7.2). In most patients, the disease started in the limbs, mostly asymmetric. None of the patients had ataxia or slow saccades. Most parents of these patients lived beyond the age of eighty years without neurodegenerative diseases. No DNA samples of the parents were available for study.



**Figure 7.1** Expanded CAG repeats in *ATXN2* in sporadic ALS. A) Distribution of CAG repeat sizes of the allele with the longest repeat in ALS patients and controls. B) Meta-analysis of the effect of CAG repeat sizes in ALS, a repeat size of 29 or higher was used as cut-off for analysis. See Appendix page 381 for Figure 7.1 in color.

**Table 7.2** Characteristics of patients with sporadic ALS patients with *ATXN2* CAG repeat size  $\geq 32$ 

| Patient no. | <i>ATXN2</i> repeat size | Gender | Age of onset (y) | Site of onset             | Survival (m) |
|-------------|--------------------------|--------|------------------|---------------------------|--------------|
| 1           | 22-32                    | M      | 52               | Spinal (right upper limb) | 9            |
| 2           | 22-32                    | F      | 56               | Spinal (left lower limb)  | 37           |
| 3           | 22-32                    | F      | 42               | Spinal (lower limbs)      | 35           |
| 4           | 22-32                    | M      | 62               | Spinal (left lower limb)  | 25           |
| 5           | 23-32                    | F      | 69               | Spinal (right upper limb) | Alive (38)   |
| 6           | 22-33                    | F      | 54               | Spinal (lower limbs)      | Alive (29)   |
| 7           | 23-33                    | M      | 35               | Spinal (right upper limb) | Alive (13)   |
| 8           | 22-34                    | F      | 52               | spinal (right upper limb) | 45           |
| 9           | 22-36                    | F      | 80               | Bulbar                    | 59           |
| 10          | 22-39                    | M      | 71               | Spinal (right upper limb) | Alive (15)   |

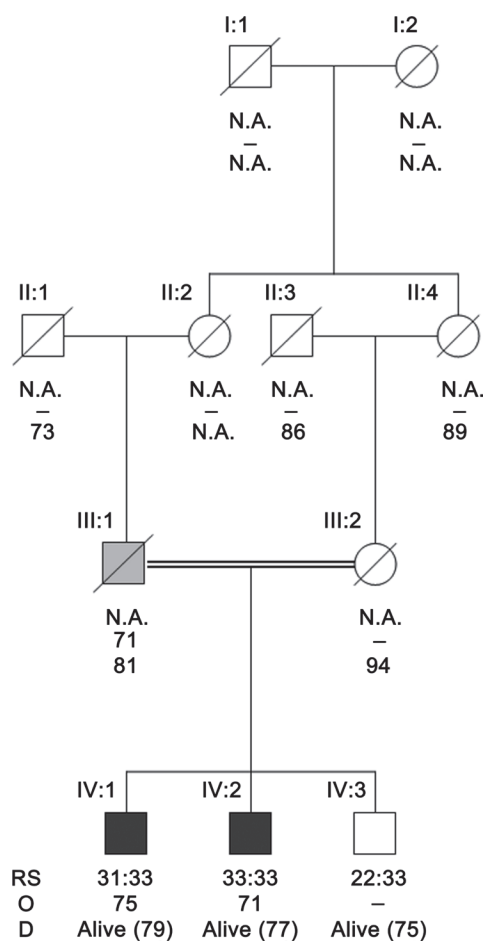
Abbreviations: M = male, F = female, y = years, and m = months.

Repeat sizes  $\leq 31$  (22–31, or 27–31 or 29–31) were not significantly different between patients with ALS and controls. However, a receiver operating characteristic analysis showed that the greatest sensitivity and specificity of discriminating ALS from control could be achieved using a cut-off of  $\geq 29$ . Repeat lengths of  $\geq 29$  were more frequently encountered in patients with ALS: 28 of 1,845 patients with ALS (1.5%) compared to 16 of 2,002 controls (0.8%). This difference was statistically significant (p-value 0.036, odds ratio [OR] 1.92, 95% confidence interval [CI] 1.04–3.64). A meta-analysis with the previously published result from the United States in 915 patients with ALS and 980 controls<sup>13</sup> demonstrated this association to be highly significant (Figure 7.1B, p-value < 0.0001, OR 2.93, 95% CI 1.73–4.98).

We did not find an association between *ATXN2* repeat length  $\geq 32$  and disease parameters including survival (p-value 0.94), age at onset (p-value 0.65), or site of onset (p-value 0.69). The analysis using a cut-off of  $\geq 29$  yielded similar results (p-value 0.46, p-value 0.57, and p-value 0.67).

Since *ATXN2* CAG repeat expansions were found in sporadic patients, we also tested patients with familial ALS in whom *SOD1*, *TARDBP*, *FUS/TLS*, and *ANG* mutations had been excluded. Samples from 103 patients belonging to 91 families were analyzed. In 2/91 families (2.2%), long repeat sizes were found. In one of these 91 pedigrees (1.1%), a repeat size of 31 was observed in a patient with classic ALS with upper limb onset.

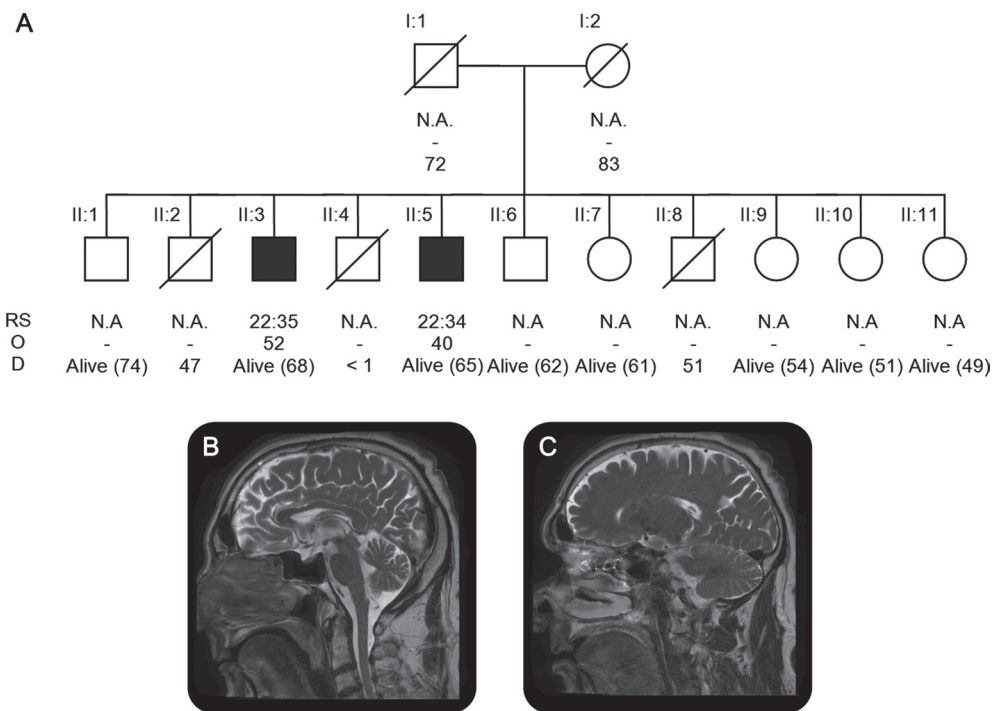
The patient died 35 months after disease onset. DNA from other family members was not available. The pedigree is shown in Supplementary Figure 7.1. In one of the other 91 pedigrees (1.1%), a repeat size of 33 was found. Remarkably, an expanded repeat size was present on both alleles in this consanguineous family. The pedigree of this family is shown in Figure 7.2. Two affected brothers had 33 repeats on one allele. One of them had 31 repeats on the other allele (IV:1), while the other was homozygous for 33 repeats (IV:2). The thus far unaffected brother had 22 and 33 repeats (IV:3). The presenting phenotype in the two affected brothers was a slowly progressive form of ALS starting in the lower limbs. An atypical feature of the clinical phenotype was some sensory abnormality



**Figure 7.2** Homozygous CAG repeat expansion in *ATXN2* in family classified as familial ALS. Pedigree of consanguineous family in which first cousins were married in generation III. Black affected, white unaffected, gray possibly affected. – = Not applicable; D = age at death; N.A. = not available; O = age at disease onset; RS = repeat size.

involvement with reduced sensory nerve action potentials on electrophysiologic testing, but no ataxia or cerebellar degeneration was found. III:1 experienced a progressive gait disorder with muscle weakness and leg stiffness spreading proximally to the bulbar region over a period of ten years, but medical advice was never sought. IV:1 and IV:2 developed a progressive upper motor neuron dominant form of ALS starting in the lower limbs at the age of 75 and 71, respectively. DNA was only available for study from individuals of generation IV.

In a family classified as SCA2, two affected siblings (with a heterozygous repeat length of 34 and 35) presented with slowly progressive lower motor neuron degeneration, consisting of muscle weakness, cramps, muscle atrophy, and fasciculations, without ataxia or eye movement abnormalities during the first years of disease. The pedigree of this family is shown in Figure 7.3A. The father (I:1) died at the age of 72 years from cardiac disease, the mother (I:2) at the age of 83 years following a stroke. Two out of



**Figure 7.3** Expanded *ATXN2* CAG repeat size with motor neuron degeneration as presenting phenotype in family classified as SCA2. A) Pedigree of family with two affected siblings with disease onset as slowly progressive lower motor neuron degeneration (Black affected). B,C) MRI of subject II:5 25 years after disease onset, shows mild cortical and superior vermis atrophy, without apparent atrophy of the cerebellar lobes or the pons on T2-weighted images.

eleven siblings presented with a neurodegenerative disorder (subjects II:3 and II:5, DNA was not available from other family members). Subjects II:2, II:4, and II:8 died before the age of 55 due to unrelated causes. All other siblings are healthy. The occurrence of cerebellar dysfunction in subject II:5 twenty years after disease onset ultimately led to a diagnosis of SCA2 (repeat size 34). Signs of upper motor neuron involvement remained absent throughout the disease course. Even 25 years after disease onset, the typical cerebellar and pontine atrophy, as seen in SCA2, was absent (Figure 7.3, B and C). Subject II:3 presented with a lower motor neuron syndrome, without ataxia or eye movement disorders to date.

## Discussion

Despite the recent advances in genetics of familial and sporadic ALS, the heritability of motor neuron degeneration is only explained in a small proportion of patients.<sup>21</sup> Genome-wide association studies (GWAS) have identified several susceptibility loci for sporadic ALS,<sup>22</sup> but only few of them appear reproducible.<sup>23,24</sup> While GWAS are suitable to identify common variants with limited effect size, they are less so for low frequency (<5% of the population) variants even when they have a relatively large effect size. Structural variations other than copy number variations, such as small deletions, insertions, translocations, or repeat expansions, remain largely unexplored.<sup>25</sup> In this study, we used a candidate gene approach and studied the occurrence of expanded CAG repeats in *ATXN2* in patients with ALS. The occurrence of expanded CAG repeats in patients with sporadic and familial ALS revealed an unexpected genetic overlap between ALS and SCA2.

In patients with sporadic ALS, repeat lengths of 29 or higher were significantly associated with ALS, in line with the recent publication that identified *ATXN2* gene as a candidate susceptibility gene for ALS.<sup>13</sup> The repeat sizes with the most significant association were longer in our study: 27–33 in the study by Elden et al.,<sup>13</sup> 32–39 in our study. Repeat lengths  $\geq 32$  were only encountered in patients with ALS. We did not observe a correlation between *ATXN2* repeat length and disease parameters such as age at onset or survival. Also in patients with an extremely variable survival time (range 24–179 months)<sup>26</sup> but the same underlying cause (a p.G93C mutation in *SOD1*,  $n = 19$ ), no correlation between *ATXN2* repeat size and survival was found.

The repeat expansions  $\geq 32$  observed in sporadic ALS possibly are *de novo* mutations, since they were never observed in controls. Unfortunately, no DNA from parents or siblings from these patients was available to confirm this.

Remarkably, long repeats were also observed in 2.2% of unexplained familial ALS. In one family, a homozygous repeat expansion was seen. The CAG repeat size has been shown to correlate with the disease phenotype in several polyglutamine disorders. Much less is known about the role of the repeat size on the other allele. Although it could be anticipated that a long repeat on the other allele would be deleterious,<sup>27</sup> the homozygous repeat expansion of 33 in one patient did not result in a particularly aggressive ALS phenotype.

The question arises whether the patients with ALS with repeat expansions of  $\geq 32$  (and certainly those with  $\geq 34$ ) should be considered as misclassified SCA2 or as proof of a genetic overlap between ALS and SCA2. Several arguments are in favor of the latter: the association of *ATXN2* repeat sizes of  $\geq 29$  with sporadic ALS, the occurrence of repeat expansions of  $\geq 32$  in sporadic patients with ALS with a typical disease presentation (with asymmetric disease onset, with a combination of upper and lower motor neuron signs and survival after disease onset as low as nine months after disease onset), the occurrence of expanded CAG repeats in familial ALS, and the observation that SCA2 can present with a pure motor neuron degeneration phenotype. Previously, three independent reports described the apparently coincidental occurrence of rapidly progressive ALS in three patients with SCA2,<sup>28-30</sup> which further supports the existence of an overlap between ALS and SCA2.

Our results demonstrate that expanded CAG repeats of  $\geq 29$  in *ATXN2* are associated with ALS, that repeat lengths of  $\geq 32$  can underlie both sporadic and familial ALS, and that SCA2 may present with motor neuron degeneration. This genetic overlap between ALS and SCA2 may contribute to our understanding of both these neurodegenerative disorders.

## Acknowledgements

We are indebted to the patients and their families who participated in this study. PVD, BD and VT hold a clinical investigatorship from the FWO-Vlaanderen. WR is supported through the E. von Behring Chair for Neuromuscular and Neurodegenerative Disorders, BD through the Biogen Idec Chair Translational Research in Multiple Sclerosis, and the Bayer Schering Pharma Chair on Fundamental Research regarding the Neuroimmunological Aspects of Multiple Sclerosis. This work is supported by the Interuniversity Attraction Poles (IUAP) program P6/43 of the Belgian Federal Science Policy Office, and by the University of Leuven (GOA 11/014 and Methusalem).



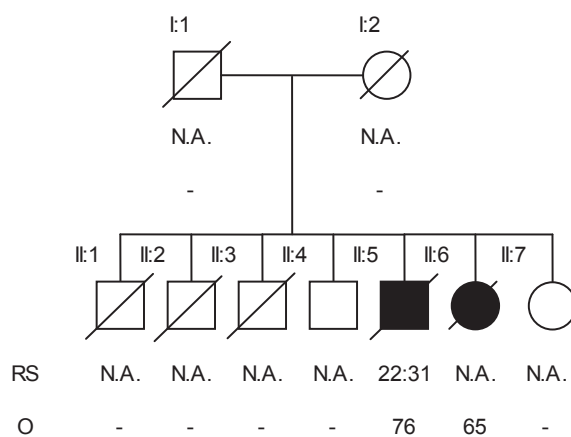
## References

- (1) Rosen DR, Siddique T, Patterson D, et al. Mutations in Cu/Zn superoxide dismutase gene are associated with familial amyotrophic lateral sclerosis. *Nature* 1993;362:59-62.
- (2) Sreedharan J, Blair IP, Tripathi VB, et al. TDP-43 mutations in familial and sporadic amyotrophic lateral sclerosis. *Science* 2008;319:1668-1672.
- (3) Kabashi E, Valdmanis PN, Dion P, et al. TARDBP mutations in individuals with sporadic and familial amyotrophic lateral sclerosis. *Nat Genet* 2008;40:572-574.
- (4) Van Deerlin VM, Leverenz JB, Bekris LM, et al. TARDBP mutations in amyotrophic lateral sclerosis with TDP-43 neuropathology: a genetic and histopathological analysis. *Lancet Neurol* 2008;7:409-416.
- (5) Kwiatkowski TJ, Jr., Bosco DA, Leclerc AL, et al. Mutations in the FUS/TLS gene on chromosome 16 cause familial amyotrophic lateral sclerosis. *Science* 2009;323:1205-1208.
- (6) Vance C, Rogelj B, Hortobagyi T, et al. Mutations in FUS, an RNA processing protein, cause familial amyotrophic lateral sclerosis type 6. *Science* 2009;323:1208-1211.
- (7) Neumann M, Sampathu DM, Kwong LK, et al. Ubiquitinated TDP-43 in frontotemporal lobar degeneration and amyotrophic lateral sclerosis. *Science* 2006;314:130-133.
- (8) Kabashi E, Lin L, Tradewell ML, et al. Gain and loss of function of ALS-related mutations of TARDBP (TDP-43) cause motor deficits in vivo. *Hum Mol Genet* 2010;19:671-683.
- (9) Wegorzewska I, Bell S, Cairns NJ, Miller TM, Baloh RH. TDP-43 mutant transgenic mice develop features of ALS and frontotemporal lobar degeneration. *Proc Natl Acad Sci U S A* 2009;106:18809-18814.
- (10) Wils H, Kleinberger G, Janssens J, et al. TDP-43 transgenic mice develop spastic paralysis and neuronal inclusions characteristic of ALS and frontotemporal lobar degeneration. *Proc Natl Acad Sci U S A* 2010;107:3858-3863.
- (11) Li Y, Ray P, Rao EJ, et al. A Drosophila model for TDP-43 proteinopathy. *Proc Natl Acad Sci U S A* 2010;107:3169-3174.
- (12) Zhou H, Huang C, Chen H, et al. Transgenic rat model of neurodegeneration caused by mutation in the TDP gene. *PLoS Genet* 2010;6:e1000887.
- (13) Elden AC, Kim HJ, Hart MP, et al. Ataxin-2 intermediate-length polyglutamine expansions are associated with increased risk for ALS. *Nature* 2010;466:1069-1075.
- (14) Sequeiros J, Seneca S, Martindale J. Consensus and controversies in best practices for molecular genetic testing of spinocerebellar ataxias. *Eur J Hum Genet* 2010;18:1188-1195.
- (15) Costanzi-Porrini S, Tessarolo D, Abbruzzese C, Liguori M, Ashizawa T, Giacanelli M. An interrupted 34-CAG repeat SCA-2 allele in patients with sporadic spinocerebellar ataxia. *Neurology* 2000;54:491-493.
- (16) Fernandez M, McClain ME, Martinez RA, et al. Late-onset SCA2: 33 CAG repeats are sufficient to cause disease. *Neurology* 2000;55:569-572.

- (17) Imbert G, Saudou F, Yvert G, et al. Cloning of the gene for spinocerebellar ataxia 2 reveals a locus with high sensitivity to expanded CAG/glutamine repeats. *Nat Genet* 1996;14:285-291.
- (18) Sanpei K, Takano H, Igarashi S, et al. Identification of the spinocerebellar ataxia type 2 gene using a direct identification of repeat expansion and cloning technique, DIRECT. *Nat Genet* 1996;14:277-284.
- (19) Pulst SM, Nechiporuk A, Nechiporuk T, et al. Moderate expansion of a normally biallelic trinucleotide repeat in spinocerebellar ataxia type 2. *Nat Genet* 1996;14:269-276.
- (20) Schols L, Bauer P, Schmidt T, Schulte T, Riess O. Autosomal dominant cerebellar ataxias: clinical features, genetics, and pathogenesis. *Lancet Neurol* 2004;3:291-304.
- (21) Dion PA, Daoud H, Rouleau GA. Genetics of motor neuron disorders: new insights into pathogenic mechanisms. *Nat Rev Genet* 2009;10:769-782.
- (22) van Es MA, Veldink JH, Saris CG, et al. Genome-wide association study identifies 19p13.3 (UNC13A) and 9p21.2 as susceptibility loci for sporadic amyotrophic lateral sclerosis. *Nat Genet* 2009;41:1083-1087.
- (23) Shatunov A, Mok K, Newhouse S, et al. Chromosome 9p21 in sporadic amyotrophic lateral sclerosis in the UK and seven other countries: a genome-wide association study. *Lancet Neurol* 2010;9:986-994.
- (24) Laaksovirta H, Peuralinna T, Schymick JC, et al. Chromosome 9p21 in amyotrophic lateral sclerosis in Finland: a genome-wide association study. *Lancet Neurol* 2010;9:978-985.
- (25) Manolio TA, Collins FS, Cox NJ, et al. Finding the missing heritability of complex diseases. *Nature* 2009;461:747-753.
- (26) Regal L, Vanopdenbosch L, Tilkin P, et al. The G93C mutation in superoxide dismutase 1: clinicopathologic phenotype and prognosis. *Arch Neurol* 2006;63:262-267.
- (27) Matsumura R, Futamura N, Fujimoto Y, et al. Spinocerebellar ataxia type 6. Molecular and clinical features of 35 Japanese patients including one homozygous for the CAG repeat expansion. *Neurology* 1997;49:1238-1243.
- (28) Nanetti L, Fancellu R, Tomasello C, Gellera C, Pareyson D, Mariotti C. Rare association of motor neuron disease and spinocerebellar ataxia type 2 (SCA2): a new case and review of the literature. *J Neurol* 2009;256:1926-1928.
- (29) Furtado S, Payami H, Lockhart PJ, et al. Profile of families with parkinsonism-predominant spinocerebellar ataxia type 2 (SCA2). *Mov Disord* 2004;19:622-629.
- (30) Infante J, Berciano J, Volpini V, et al. Spinocerebellar ataxia type 2 with Levodopa-responsive parkinsonism culminating in motor neuron disease. *Mov Disord* 2004;19:848-852.

## SUPPLEMENT

### Supplementary Figure



7

**Supplementary Figure 7.1** Pedigree of family with heterozygous CAG repeat size of 31 in index patient (Black affected). – = Not applicable; D = age at death; N.A. = not available; O = age at disease onset; RS = repeat size.

# 8

**“Never forget that every single organic being around us may be said to be striving to the utmost to increase in numbers; that each lives by a struggle at some period of its life; that heavy destruction inevitably falls either on the young or old, during each generation or at recurrent intervals.”**

Darwin, *On the Origin of Species*.

# Hexanucleotide repeat expansions in *C9orf72* in the spectrum of motor neuron diseases

Wouter van Rheenen, Marka van Blitterswijk, Mark H.B. Huisman, Lotte Vlam,  
Perry T.C. van Doormaal, Meini Seelen, Jelena Medic, Dennis Dooijes,  
Marianne de Visser, Anneke J. van der Kooi, Joost Raaphorst,  
Helenius J. Schelhaas, W.-Ludo van der Pol, Jan H. Veldink\*, Leonard H. van den Berg\*

\* Contributed equally to this work.

*Neurology*. In press.

## Abstract

**Objective:** To assess the frequency and phenotype of hexanucleotide repeat expansions in chromosome 9 open reading frame 72 (*C9orf72*) in a large cohort of patients with familial (FALS) and sporadic (SALS) amyotrophic lateral sclerosis (ALS), progressive muscular atrophy (PMA) and primary lateral sclerosis (PLS) of Dutch descent.

**Methods:** We included 78 patients with FALS, 1,422 patients with SALS, 246 patients with PMA, 110 patients with PLS, and 768 control subjects. Repeat expansions were determined by a repeat primed PCR. Familial aggregation of dementia and Parkinson's disease was examined among patients with the repeat expansion.

**Results:** The expanded repeat was found in 33 (37%) of all FALS, in 87 (6.1%) of SALS, four (1.6%) of PMA patients and in one (0.9%) PLS patient. None of the controls carried the mutation. ALS patients with the repeat expansion had an earlier age at onset (median 59.3 versus 61.9 years, hazard ratio [HR] 1.55, p-value  $5 \times 10^{-5}$ ) and shorter survival (median 2.5 versus 2.7 years, HR 1.46, p-value  $8 \times 10^{-4}$ ). Dementia, but not Parkinson's disease, occurred nearly twice as often in relatives of patients with the expansion compared to all ALS patients or controls (p-value  $9 \times 10^{-4}$ ).

**Conclusions:** The hexanucleotide repeat expansion in *C9orf72* is a major cause of FALS and apparently SALS in The Netherlands. Patients with the repeat expansion have an earlier onset, shorter survival and familial aggregation of dementia. These results challenge the classical definition of FALS and may justify genetic testing in patients with SALS.

## Introduction

Amyotrophic lateral sclerosis (ALS) is a progressive neurodegenerative disease affecting both upper and lower motor neurons. On average, patients die within three years due to respiratory insufficiency.<sup>1</sup> The exact disease course of ALS is, however, hard to predict with 10% of the patients surviving longer than ten years and others dying within months.<sup>2</sup> Mild to severe frontotemporal cognitive dysfunction and behavioral changes are seen in up to 50% of ALS patients.<sup>3</sup> On the other hand 14% of the patients with frontotemporal dementia (FTD) develop symptoms and signs suggestive of motor neuron disease at a certain stage in the disease course.<sup>4</sup> For these reasons, ALS and FTD might be considered as entities of one neurodegenerative syndrome.

Recently, an intronic hexanucleotide repeat expansion in chromosome 9 open reading frame 72 (*C9orf72*), containing an expansion ranging from thirty to hundreds of GGGGCC repeats, was identified in 23.5-61.5% of the FALS and FTD cases from different cohorts.<sup>5,6</sup> Importantly, the repeat expansion was also present in 4.1% of the 195 non-Finnish SALS cases, suggesting that a *C9orf72* repeat expansion is the most frequent and most strongly associated genetic abnormality seen in ALS.

To determine whether patients with a repeat expansion in *C9orf72* exhibit a distinct clinical phenotype, we genotyped a large cohort of well-phenotyped patients with ALS and pure lower or upper motor neuron variants.

## Methods

### Patient selection

Patients were recruited from the out-patient clinic for neuromuscular diseases at the University Medical Center Utrecht, Radboud University Medical Center Nijmegen and Academic Medical Center Amsterdam, which are tertiary referral centers for patients with ALS in The Netherlands. Additionally, patients participating in the prospective population based study on motor neuron diseases in The Netherlands were included.<sup>7</sup> All patients with ALS fulfilled the revised El Escorial Criteria for ALS.<sup>8</sup> FALS was defined as the presence of at least one family member with ALS, PMA or PLS. Considering the overlap of ALS and FTD, we also defined FALS according to more liberal criteria: the presence of a relative with ALS, PMA, PLS or any form of dementia. These patients did not have mutations in superoxide dismutase-1 (*SOD1*), TAR DNA-binding protein (*TARDBP*) and fused in sarcoma / translated in liposarcoma (*FUS/TLS*). Patients with

PMA showed signs and symptoms of pure lower motor neuron impairment and fulfilled the previously described diagnostic criteria.<sup>9</sup> Patients with PLS exhibited progressive spastic paresis; other explanations (i.e. myelopathy, infectious disease, hereditary spastic paraplegia etc.) were ruled out, as described elsewhere.<sup>10</sup> Control subjects were unrelated population-based individuals, matched for gender and age, free of any neuromuscular disease.<sup>7</sup>

### Standard protocol approvals, registrations and patient consents

All patients and control subjects gave written informed consent, and the medical ethics commission of the University Medical Center Utrecht approved this study.

### Genetic analysis

DNA was extracted from venous blood using standard protocols. To detect large expanded repeats a repeat primed PCR for the *C9orf72* GGGGCC repeat was performed on genomic DNA. Previous studies validated this PCR method for detection of the expanded *C9orf72* repeat by Southern blots.<sup>5,6</sup> The primers and protocol applied are described in the Supplement (Supplementary Table 8.1 and 8.2). Fragment analysis was performed on an ABI3730xl sequencer and visualized with GeneMapper software version 3.7 (Applied Biosystems, Foster City, California). Alleles with thirty or more GGGGCC hexanucleotide repeats were considered as expanded. To avoid false negative calls, we genotyped all samples at least twice. For the haplotype analysis, we used genotypes of the single nucleotide polymorphisms (SNPs) at the 9p21.2 locus derived from a previously performed genome wide associations study (GWAS).<sup>11</sup> The Supplement provides further details on the haplotype analysis.

### Description of the clinical phenotype

For ALS patients, age at onset was defined as age at first signs of muscle weakness in a limb, dysphagia or dysarthria. Survival was defined as time from age at onset until death, tracheostomy or requirement of continuous ventilatory assistance. Detailed information on the presence of cognitive and behavioral deficits was not available for the patients and their relatives. However, information on the presence of dementia, in general, among relatives of ALS patients was available through our prospective population based study on motor neuron diseases in The Netherlands.<sup>7</sup> In this study, ALS patients and population based control subjects were asked whether dementia or Parkinson's disease affected certain family members of first- or second-degree.



## Statistical analysis

For survival and age at onset a Cox proportional hazards model was used in which we corrected for gender and site of onset, as well as for age at onset in the survival analysis. An association between the *C9orf72* repeat expansion and site of onset was assessed in a multivariate analysis by logistic regression, correcting for gender. In the analysis of the family history we calculated lambda values for the rate of affected family members per stratum: all ALS patients, ALS patients with *C9orf72* expansions and controls. The lambda value was defined by dividing the rate of family members affected in the patients group by the rate of family members affected in control subjects, p-values were calculated by a two-tailed Fisher's exact test. All statistical analyses were performed using R v2.10 software ([www.r-project.org](http://www.r-project.org)). P-values < 0.05 were considered statistically significant.

## Results

In total, we included probands with FALS from 78 apparently unrelated families, 1,422 patients with SALS, 246 patients with PMA, 110 patients with PLS and 768 control subjects. The characteristics of all participants are displayed in Table 8.1, showing only small differences in age and gender between the different groups. All patients and control subjects were Caucasian and of Dutch descent.

The repeat primed PCR revealed the *C9orf72* hexanucleotide expansion in 33 families with FALS without earlier described mutations, accounting for 37% of all the unrelated families with FALS in The Netherlands (Table 8.2). When we handled the more liberal criteria for FALS nearly one quarter of the patients had the *C9orf72* repeat expansion.

**Table 8.1** Baseline characteristics

|              | Number of patients | Female (%) | Age at inclusion (median ± SD) | Age at onset, (median ± SD) | Bulbar onset (%) | Survival, years (median ± SD) |
|--------------|--------------------|------------|--------------------------------|-----------------------------|------------------|-------------------------------|
| Familial ALS | 78                 | 47         | 63.5 ± 11.2                    | 60.6 ± 11.0                 | 22               | 2.9 ± 3.1                     |
| Sporadic ALS | 1422               | 40         | 65.1 ± 11.5                    | 61.7 ± 11.7                 | 32               | 2.6 ± 3.3                     |
| PMA          | 246                | 29         | 62.9 ± 10.8                    | 58.8 ± 13.4                 | 1.8              | 5.6 ± 7.2                     |
| PLS          | 110                | 43         | 61.8 ± 9.7                     | 54.6 ± 12.0                 | 15               | 8.5 ± 7.2                     |
| Controls     | 768                | 47         | 63.1 ± 11.8                    |                             |                  |                               |

Abbreviations: ALS = amyotrophic lateral sclerosis, PMA = progressive muscular atrophy, PLS = primary lateral sclerosis, and SD = standard deviation.

**Table 8.2** *C9orf72* repeat expansion frequency

|  | n    | <i>C9orf72</i> expansion | %    |
|--|------|--------------------------|------|
| Familial ALS                               |      |                          |      |
| Stringent <sup>a</sup>                     | 78   | 33                       | 42.3 |
| Liberal <sup>b</sup>                       | 259  | 51                       | 19.7 |
| Sporadic ALS                               |      |                          |      |
| Total                                      | 1422 | 87                       | 6.1  |
| + Family history for dementia <sup>c</sup> | 181  | 18                       | 9.9  |
| - Family history for dementia <sup>d</sup> | 351  | 16                       | 4.6  |
| PMA  | 246  | 4                        | 1.6  |
| PLS  | 110  | 1                        | 0.9  |
| Controls                                   | 768  | 0                        | 0    |

Abbreviation: n = number.

<sup>a</sup> Familial ALS defined as presence of a relative with ALS, PMA or PLS. <sup>b</sup> Familial ALS defined as presence of a relative with ALS, PMA, PLS or dementia. <sup>c</sup> Patients with apparently sporadic ALS and positive family history for dementia. <sup>d</sup> Patients with apparently sporadic ALS and negative family history for dementia.

The detailed family history was available for 532 patients with sporadic ALS.

In the patients with apparently SALS, e.g. without a positive family history for ALS, the repeat expansion was found in 87 patients (6.1%). None of the control subjects carried the expansion. Four PMA patients (1.6%) had a repeat containing more than thirty GGGGCC repeats. Reviewing their clinical data showed that none of the patients presented any upper motor neuron signs during follow-up, which ranged from four to twenty years. These four patients were still alive 4, 4.2, 5.4 and 21 years after disease onset. We found the repeat expansion in only one patient (0.9%) with PLS. This patient suffered from progressive symptoms in both arms and legs. Four years after the disease onset this patient is still alive and at neurological examination upper motor neuron signs are present exclusively. Neither the patients with PMA, nor the patient with PLS reported on family members affected by dementia.

The majority of the ALS patients with the *C9orf72* mutation shared the haplotype at 9p21.2 that has been associated with ALS in a previous study.<sup>12</sup> Patients without the repeat expansion had this haplotype less often (66% versus 22% respectively, p-value  $4.3 \times 10^{-18}$ , Supplementary Figure 8.1, Supplementary Table 8.3).

Patients with a *C9orf72* expansion appeared to have an earlier disease onset. On average, this occurred two and a half years earlier in patients with the expanded hexanucleotide

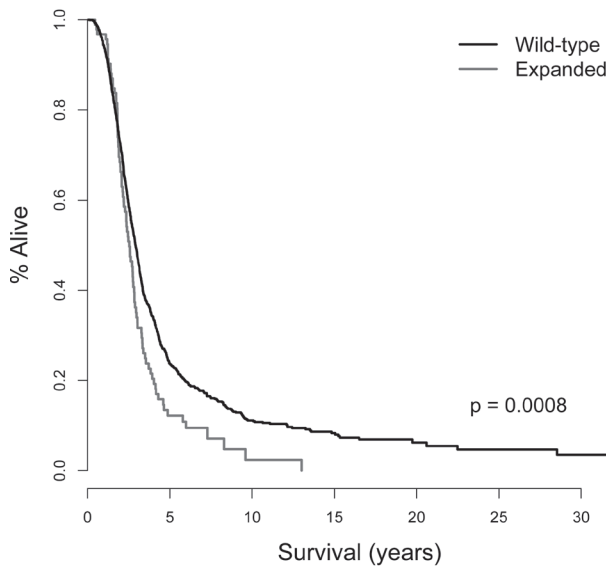
repeat compared to patients without the repeat expansion, as shown in Table 8.3. The median survival was nearly two and a half months shorter in patients with the hexanucleotide expansion (Table 8.3 and Figure 8.1). Both differences in age at onset and survival reached statistical significance.

We did not observe a difference in the frequency of bulbar onset between patients with the repeat and those homozygous for wild-type *C9orf72* (39% versus 31%, p-value 0.23, odds ratio [OR] 1.31, 95% confidence interval [CI]: 0.84 - 2.02).

**Table 8.3** Survival and age at onset

|                            | Median (range)     | HR (95% CI)        | P-value |
|----------------------------|--------------------|--------------------|---------|
| <b>Age at onset, years</b> |                    |                    |         |
| Wild-type                  | 61.9 (19.5 – 88.5) | -                  | -       |
| Expansion                  | 59.3 (37.6 – 82.9) | 1.55 (1.25 – 1.92) | 0.00005 |
| <b>Survival, years</b>     |                    |                    |         |
| Wild-type                  | 2.7 (0.13 – 31.8)  | -                  | -       |
| Expansion                  | 2.5 (0.45 – 13.0)  | 1.46 (1.17 – 1.83) | 0.00079 |

Abbreviations: HR = hazard ratio, and CI = confidence interval.



**Figure 8.1** Survival for *C9orf72* repeat genotype. See Appendix page 382 for Figure 8.1 in color.

**Table 8.4** Family history

|                                     | Proband (n) | Relatives (n) | Affected (n) | Rate  | $\lambda$ (95% CI) | P-value |
|-------------------------------------|-------------|---------------|--------------|-------|--------------------|---------|
| <b>Dementia</b>                     |             |               |              |       |                    |         |
| Controls                            | 1,616       | 15,690        | 667          | 0.043 | -                  | -       |
| ALS (total)                         | 550         | 5,253         | 251          | 0.048 | 1.12 (0.98–1.30)   | 0.13    |
| ALS ( <i>C9orf72</i> ) <sup>a</sup> | 36          | 320           | 28           | 0.088 | 2.06 (1.43–2.95)   | 0.0009  |
| <b>Parkinson's disease</b>          |             |               |              |       |                    |         |
| Controls                            | 1,616       | 15,690        | 143          | 0.009 | -                  | -       |
| ALS (total)                         | 550         | 5,269         | 56           | 0.011 | 1.17 (0.86–1.59)   | 0.60    |
| ALS ( <i>C9orf72</i> )*             | 36          | 317           | 4            | 0.013 | 1.38 (0.52–3.72)   | 0.54    |

<sup>a</sup> Patients with ALS that have the *C9orf72* repeat expansion.

We analyzed the family history of patients with apparently SALS for the occurrence of dementia and Parkinson's disease among relatives. In total, 550 patients genotyped for the GGGGCC repeat enrolled in the prospective population based study on motor neuron diseases in The Netherlands, in which they were asked if certain family members were affected by dementia or Parkinson's disease.<sup>7</sup> Data analysis showed that dementia occurred more frequently among first- and second-degree relatives of patients with the expanded *C9orf72* repeat, compared to healthy controls and ALS patients in general (Table 8.4). This effect was not observed for Parkinson's disease (Table 8.4).

## Discussion

The discovery of the *C9orf72* hexanucleotide repeat expansions has had an enormous impact in the field of ALS and FTD research, being the most common cause of these diseases occurring in families.<sup>5,6</sup> In our large screening for the *C9orf72* hexanucleotide repeat expansion, we detected this genetic mutation as the most common cause of FALS in The Netherlands, accounting for 37% of the families. Furthermore, a considerable percentage of the patients with sporadic ALS also have this mutation. Patients that had the *C9orf72* repeat expansion exhibited a more aggressive disease course with an earlier disease debut and shorter survival, and more frequently had a positive family history for dementia. The clinical phenotype remained very variable, and repeat expansions were found in patients that exhibited slowly progressive lower motor neuron and upper motor neuron impairment exclusively.

The repeat expansion was virtually absent in healthy unrelated control subjects. Although the exact penetrance of this mutation is not known yet, current and previous data support the notion that the *C9orf72* hexanucleotide repeat expansion can be considered to be a highly pathogenic mutation, instead of merely a risk factor.

The high frequency of *C9orf72* mutations in apparently SALS is remarkable. Although none of these patients report affected family members, they might be in fact FALS cases, which can be explained in several ways. A combination of a non-fully penetrant mutation and small family sizes increases the number of unrecognized families with ALS.<sup>13</sup> Although the penetrance of the *C9orf72* repeat expansion might not be comparable to *SOD1* mutations, the observed rate of mutations in apparently sporadic ALS is substantially higher for *C9orf72* (6.1% versus  $\pm 2\%$ ).<sup>14</sup> An additional explanation might be that the expansions cause both ALS and FTD exclusively. This way, families might not be recognized if the link between family members with ALS and FTD has never been made. This is supported by our observation that relatives of patients with the repeat expansion suffer from dementia more often. These family members could have had dementia caused by the *C9orf72* expansion, true FTD or amnesic dementia resembling Alzheimer's disease, which has been associated with the repeat expansions as well.<sup>15;16</sup> Finally, the high rate of *C9orf72* expansions in sporadic ALS cases can reflect *de novo* repeat expansions or anticipation of a premutation in earlier generations, a well-described mechanism in other diseases associated with repeat expansions.<sup>17</sup>

Presently, standard genetic testing for patients with SALS is not recommended.<sup>18</sup> The observed rate of *C9orf72* mutations in apparently SALS may justify genetic testing in these patients. For improved genetic counseling, however, future studies will need to address the issues on mode of inheritance, penetrance and further define the clinical phenotype.

The identification of patients with PMA and PLS that have the repeat expansion extends the spectrum of diseases associated with the GGGGCC hexanucleotide repeat beyond classical ALS, FTD and dementia mimicking Alzheimer's disease. Identifying genetic or environmental modifiers for this variety in clinical phenotype will provide greater insight into the etiology of ALS and may lead to new therapeutic strategies. This challenge will require large cohorts of extensively phenotyped and genotyped patients to ensure the studies have sufficient statistical power.

The main limitation of this study is the lack of information on cognitive and behavioral dysfunction, which limits our ability to fully investigate FTD in relation to the repeat expansion. Instead, the data on dementia, in general, among relatives was available in a

large sample of patients and controls. Ideally, a clinician should have verified the family history in a personal interview so relatives with true FTD could have been identified. However, this approach is laborious and reduces the number of patients that can be included. As a consequence, this would have greatly reduced statistical power that was achieved by using the questionnaires. Because of the methodological limitations the results from the questionnaires on the family history should only be regarded as suggestive for the statement that FTD occurs more frequently among those related to apparently sporadic ALS patients with the *C9orf72* repeat expansion.

Our study identified the hexanucleotide repeat expansion in *C9orf72* as a major cause of familial and apparently sporadic ALS with a more aggressive disease course.

## References

- (1) Kiernan MC, Vucic S, Cheah BC, et al. Amyotrophic lateral sclerosis. *Lancet* 2011;377:942-955.
- (2) del Aguila MA, Longstreth WT, McGuire V, Koepsell TD, van Belle G. Prognosis in amyotrophic lateral sclerosis: a population-based study. *Neurology* 2003;60:813-819.
- (3) Ringholz GM, Appel SH, Bradshaw M, Cooke NA, Mosnik DM, Schulz PE. Prevalence and patterns of cognitive impairment in sporadic ALS. *Neurology* 2005;65:586-590.
- (4) Lomen-Hoerth C, Anderson T, Miller B. The overlap of amyotrophic lateral sclerosis and frontotemporal dementia. *Neurology* 2002;59:1077-1079.
- (5) DeJesus-Hernandez M, Mackenzie IR, Boeve BF, et al. Expanded GGGGCC hexanucleotide repeat in noncoding region of C9ORF72 causes chromosome 9p-linked FTD and ALS. *Neuron* 2011;72:245-256.
- (6) Renton AE, Majounie E, Waite A, et al. A hexanucleotide repeat expansion in C9ORF72 is the cause of chromosome 9p21-linked ALS-FTD. *Neuron* 2011;72:257-268.
- (7) Huisman MHB, de Jong SW, Verwijns MC, et al. Family history of neurodegenerative and vascular diseases in ALS: a population-based study. *Neurology* 2011;77:1363-1369.
- (8) Brooks BR, Miller RG, Swash M, Munsat TL. El Escorial revisited: revised criteria for the diagnosis of amyotrophic lateral sclerosis. *Amyotroph Lateral Scler Other Motor Neuron Disord* 2000;1:293-299.
- (9) Van den Berg-Vos RM, Visser J, Kalmijn S, et al. A long-term prospective study of the natural course of sporadic adult-onset lower motor neuron syndromes. *Arch Neurol* 2009;66:751-757.
- (10) Brugman F, Veldink JH, Franssen H, et al. Differentiation of hereditary spastic paraparesis from primary lateral sclerosis in sporadic adult-onset upper motor neuron syndromes. *Arch Neurol* 2009;66:509-514.
- (11) van Es M, Veldink J, Saris C, et al. Genome-wide association study identifies 19p13.3 (UNC13A) and 9p21.2 as susceptibility loci for sporadic amyotrophic lateral sclerosis. *Nat Genet* 2009;41:1083-1087.

- (12) Mok K, Traynor BJ, Schymick J, et al. The chromosome 9 ALS and FTD locus is probably derived from a single founder. *Neurobiol Aging* 2012;33:209.e3-e8.
- (13) Al-Chalabi A, Lewis CM. Modelling the Effects of Penetrance and Family Size on Rates of Sporadic and Familial Disease. *Hum Hered* 2011;71:281-288.
- (14) van Es MA, Dahlberg C, Birve A, Veldink JH, van den Berg LH, Andersen PM. Large-scale SOD1 mutation screening provides evidence for genetic heterogeneity in amyotrophic lateral sclerosis. *J Neurol Neurosurg Psychiatry* 2010;81:562-566.
- (15) Murray ME, DeJesus-Hernandez M, Rutherford NJ, et al. Clinical and neuropathologic heterogeneity of c9FTD/ALS associated with hexanucleotide repeat expansion in C9ORF72. *Acta Neuropathol* 2011;122:673-690.
- (16) Majounie E, Abramzon Y, Renton AE, et al. Repeat Expansion in C9ORF72 in Alzheimer's Disease. *N Engl J Med* 2012;366:283-284. Letter.
- (17) Abbruzzese C, Costanzi Porrini S, Mariani B, et al. Instability of a premutation allele in homozygous patients with myotonic dystrophy type 1. *Ann Neurol* 2002;52:435-441.
- (18) Andersen PM, Al-Chalabi A. Clinical genetics of amyotrophic lateral sclerosis: what do we really know? *Nat Rev Neurol* 2011;7:603-615.

## SUPPLEMENT

### *C9orf72* repeat and the 9p21.2 haplotype

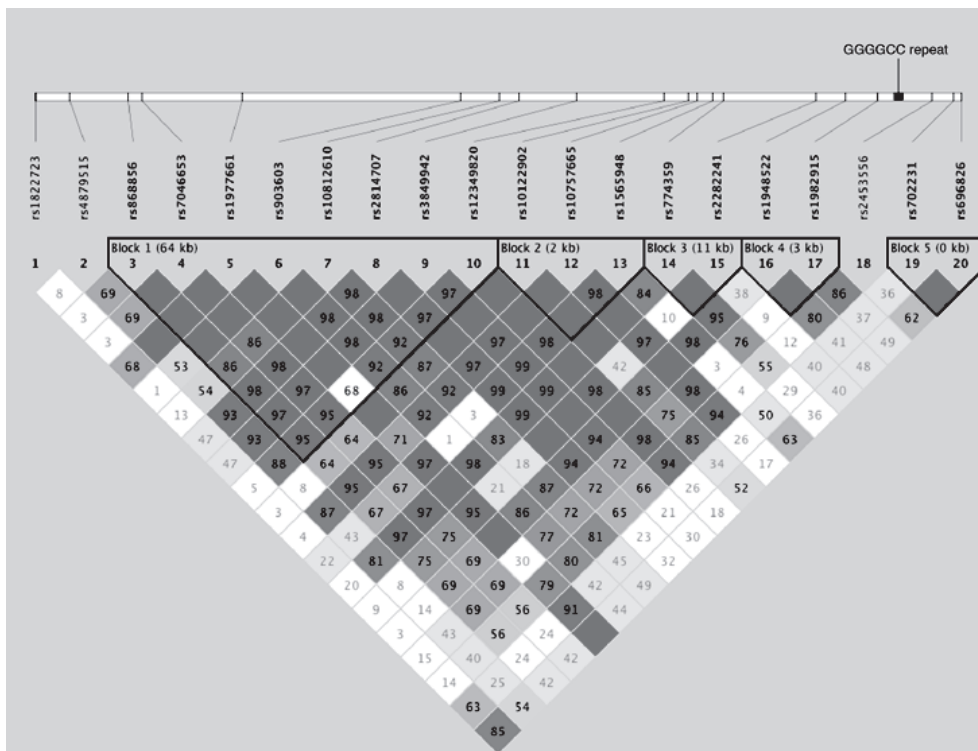
For 630 patients with ALS and a known *C9orf72* genotype, SNP genotypes were available from genome wide association studies (GWAS) that were performed earlier.<sup>1</sup> For these patients, forty had the repeat expansion (two FALS and 38 SALS) and 590 patients were homozygous for the wild-type *C9orf72* gene (five FALS and 585 SALS). Quality control for these data was performed, as described previously.<sup>1</sup> We tested twenty SNPs within the reported haplotype block at chromosome 9p21.2 (chr9:27468052-27579657) for an association with the *C9orf72* repeat expansion.<sup>2</sup> This was done in Haploview v4.2 software for the detection of haplotypes.<sup>3</sup> We used the Chi-square test to determine the association between different haplotypes and the *C9orf72* repeat expansion.

## Supplementary References

- (1) van Es M, Veldink J, Saris C, et al. Genome-wide association study identifies 19p13.3 (UNC13A) and 9p21.2 as susceptibility loci for sporadic amyotrophic lateral sclerosis. *Nat Genet* 2009;41:1083-1087.
- (2) Mok K, Traynor BJ, Schymick J, et al. The chromosome 9 ALS and FTD locus is probably derived from a single founder. *Neurobiol Aging* 2012;33:209.e203-e208.
- (3) Barrett JC, Fry B, Maller J, Daly MJ. Haploview: analysis and visualization of LD and haplotype maps. *Bioinformatics* 2005;21:263-265.



# Supplementary Figure



8

**Supplementary Figure 8.1** Haplotype blocks. See Appendix page 382 for Supplementary Figure 8.1 in color.

## Supplementary Tables

**Supplementary Table 8.1** RP-PCR reaction mix

| Reagent                   | Volume      | Final concentration |
|---------------------------|-------------|---------------------|
| Roche FastStart Mix (2x)  | 14 $\mu$ L  | 1x                  |
| RP-PCR-F1                 | 0.4 $\mu$ L | 1.4 $\mu$ M         |
| RP-PCR-R                  | 0.2 $\mu$ L | 0.7 $\mu$ M         |
| RP-PCR-anchor             | 0.4 $\mu$ L | 1.4 $\mu$ M         |
| DMSO                      | 2 $\mu$ L   | 7%                  |
| Qiagen Q solution (5x)    | 5 $\mu$ L   | 1x                  |
| NEB deazaGTP (5 mM)       | 1 $\mu$ L   | 0.19 mM             |
| MgCl <sub>2</sub> (25 mM) | 1 $\mu$ L   | 0.93 mM             |
| gDNA                      | 3 $\mu$ L   | 100 ng              |
| MQ                        | 1 $\mu$ L   | -                   |

Abbreviations: RP-PCR = repeat primed polymerase chain reaction, DMSO = dimethylsulfoxide, NEB = New England Biolabs, gDNA = genomic DNA, and MQ = milliQ.

Primer sequences:

RP-PCR-F1: 5' - 6FAM-AGTCGCTAGAGGCGAAAGC - 3'

RP-PCR-R: 5' - TACGCATCCCAGTTTGAGACGGGGCCGGGGCCGGGGCCGGGG - 3'

RP-PCR-anchor: 5' - TACGCATCCCAGTTTGAGACG - 3'

**Supplementary Table 8.2** PCR cycling conditions

| Cycle | Temperature | Time       | Repeated |
|-------|-------------|------------|----------|
| 0     | 95°C        | 15 minutes |          |
| 1     | 94°C        | 1 minute   | 2 cycles |
|       | 70°C        | 1 minute   |          |
|       | 72°C        | 3 minutes  |          |
| 2     | 94°C        | 1 minute   | 3 cycles |
|       | 68°C        | 1 minute   |          |
|       | 72°C        | 3 minutes  |          |
| 3     | 94°C        | 1 minute   | 4 cycles |
|       | 66°C        | 1 minute   |          |
|       | 72°C        | 3 minutes  |          |
| 4     | 94°C        | 1 minute   | 5 cycles |
|       | 64°C        | 1 minute   |          |
|       | 72°C        | 3 minutes  |          |
| 5     | 94°C        | 1 minute   | 6 cycles |
|       | 62°C        | 1 minute   |          |
|       | 72°C        | 3 minutes  |          |
| 6     | 94°C        | 1 minute   | 7 cycles |
|       | 60°C        | 1 minute   |          |
|       | 72°C        | 3 minutes  |          |
| 7     | 94°C        | 1 minute   | 8 cycles |
|       | 58°C        | 1 minute   |          |
|       | 72°C        | 3 minutes  |          |
| 8     | 94°C        | 1 minute   | 5 cycles |
|       | 56°C        | 1 minute   |          |
|       | 72°C        | 3 minutes  |          |
| 9     | 72°C        | 10 minutes |          |

Supplementary Table 8.3 SNP and haplotype association

| SNP        | Associated allele | Frequency (expanded) | Frequency (wild-type) | P-value               | Haplotype block | Associated haplotype | Frequency (expanded) | Frequency (wild-type) | P-value               |
|------------|-------------------|----------------------|-----------------------|-----------------------|-----------------|----------------------|----------------------|-----------------------|-----------------------|
| rs1822723  | G                 | 0.762                | 0.730                 | 0.5                   |                 |                      |                      |                       |                       |
| rs4879515  | A                 | 0.700                | 0.459                 | $3.0 \times 10^{-5}$  |                 |                      |                      |                       |                       |
| rs868856   | A                 | 0.688                | 0.268                 | $1.6 \times 10^{-15}$ | 1               | A                    |                      |                       |                       |
| rs7046653  | A                 | 0.688                | 0.268                 | $1.6 \times 10^{-15}$ | 1               | A                    |                      |                       |                       |
| rs1977661  | C                 | 0.950                | 0.902                 | 0.2                   | 1               | C                    |                      |                       |                       |
| rs903603   | G                 | 0.788                | 0.519                 | $3.1 \times 10^{-6}$  | 1               | G                    |                      |                       |                       |
| rs10812610 | C                 | 0.762                | 0.497                 | $4.1 \times 10^{-6}$  | 1               | C                    |                      |                       |                       |
| rs2814707  | A                 | 0.650                | 0.221                 | $8.7 \times 10^{-18}$ | 1               | A                    |                      |                       |                       |
| rs3849942  | A                 | 0.650                | 0.222                 | $1.1 \times 10^{-17}$ | 1               | A                    |                      |                       |                       |
| rs12349820 | A                 | 0.950                | 0.772                 | $2.0 \times 10^{-4}$  | 1               | A                    | 0.646                | 0.216                 | $4.3 \times 10^{-18}$ |
| rs10122902 | G                 | 0.925                | 0.743                 | $3.0 \times 10^{-4}$  | 2               | G                    |                      |                       |                       |
| rs10757665 | A                 | 0.950                | 0.771                 | $2.0 \times 10^{-4}$  | 2               | A                    |                      |                       |                       |
| rs1565948  | G                 | 0.825                | 0.469                 | $6.8 \times 10^{-10}$ | 2               | G                    | 0.825                | 0.469                 | $6.8 \times 10^{-10}$ |
| rs774359   | G                 | 0.688                | 0.242                 | $3.4 \times 10^{-18}$ | 3               | G                    |                      |                       |                       |
| rs2282241  | C                 | 0.762                | 0.558                 | $3.0 \times 10^{-4}$  | 3               | C                    | 0.688                | 0.242                 | $4.5 \times 10^{-18}$ |
| rs1948522  | G                 | 0.925                | 0.753                 | $5.0 \times 10^{-4}$  | 4               | G                    |                      |                       |                       |
| rs1982915  | G                 | 0.762                | 0.508                 | $1.1 \times 10^{-5}$  | 4               | G                    | 0.688                | 0.261                 | $4.0 \times 10^{-16}$ |
| rs2453556  | G                 | 0.650                | 0.446                 | $4.0 \times 10^{-4}$  |                 |                      |                      |                       |                       |
| rs702231   | A                 | 0.875                | 0.757                 | $1.6 \times 10^{-2}$  | 5               | A                    |                      |                       |                       |
| rs696826   | G                 | 0.938                | 0.822                 | $7.9 \times 10^{-3}$  | 5               | G                    | 0.875                | 0.7257                | $1.6 \times 10^{-2}$  |

Abbreviation: SNP = single nucleotide polymorphism.

# 8

# 9

**“For men usually guess at new things in the light of things that happened before, their imagination being preoccupied and coloured by them. This way of forming opinions is very prone to error, since many of the waters we seek from the springs of Nature do not flow along familiar channels.”**

Francis Bacon, *Novum Organum*.

# Evidence for a polygenic basis of amyotrophic lateral sclerosis

Marka van Blitterswijk, Michael A. van Es, Eric A.M. Hennekam, Dennis Dooijes, Wouter van Rheenen, Jelena Medic, Pierre R. Bourque, Helenius J. Schelhaas, Anneke J. van der Kooi, Marianne de Visser, Paul I.W. de Bakker, Jan H. Veldink\*, Leonard H. van den Berg\*

\* Contributed equally to this work.

Submitted for publication.

## Abstract

**Objective:** Amyotrophic lateral sclerosis (ALS) is a fatal neurodegenerative disorder with a substantial heritable component. In pedigrees affected by the familial form of this disease (FALS), however, incomplete penetrance is often observed. We hypothesized that this could be caused by complex inheritance of risk variants in multiple genes. Therefore, we screened five major ALS-associated genes for mutations in FALS patients, sporadic ALS (SALS) patients, and control subjects of Dutch descent.

**Methods:** 111 FALS patients from 97 families, and large cohorts of SALS patients and control subjects were screened for mutations in TAR DNA-binding protein (*TARDBP*), fused in sarcoma/translated in liposarcoma (*FUS/TLS*), superoxide dismutase-1 (*SOD1*), angiogenin (*ANG*), and chromosome 9 open reading frame 72 (*C9orf72*).

**Results:** Mutations were identified in 48% of FALS families, 8% of SALS patients, and 0.5% of control subjects. In five of the FALS families (5.2%) we identified multiple mutations in ALS-associated genes. We detected *FUS/TLS* and *TARDBP* mutations in combination with *ANG* mutations, and *C9orf72* repeat expansions with *TARDBP*, *SOD1*, and *FUS/TLS* mutations. Statistical analysis demonstrated that the presence of multiple mutations in five out of 97 FALS families is in excess of what is to be expected by chance ( $p\text{-value } 1.77 \times 10^{-7}$ ). One *TARDBP* mutation (p.N352S) was identified in three SALS patients and five FALS families. Genealogical and haplotype analyses revealed that these individuals shared a common ancestor. In total, we obtained DNA of fourteen patients with this *TARDBP* mutation, 50% of whom had an additional mutation (*ANG*, *C9orf72* or homozygous *TARDBP*).

**Interpretation:** We provide strong evidence for a polygenic etiology of ALS. This may have important implications for the interpretation of whole exome/genome experiments designed to identify new ALS-associated genes, and for genetic counseling, especially of unaffected family members.



## Introduction

Amyotrophic lateral sclerosis (ALS) is a complex disorder affecting upper and lower motor neurons, resulting in severe muscle weakness. The incidence of ALS is approximately 2-3 per 100,000 per year, and on average patients die within five years after onset of symptoms.<sup>1-3</sup> To date, several genes are known to be involved in the pathogenesis of ALS, including TAR DNA-binding protein (*TARDBP*), fused in sarcoma / translated in liposarcoma (*FUS/TLS*), superoxide dismutase-1 (*SOD1*), and angiogenin (*ANG*).<sup>4,5</sup>

Recently, a pathogenic hexanucleotide repeat expansion in chromosome 9 open reading frame 72 (*C9orf72*) has also been identified. This repeat expansion was present in up to 62% of the cases with both familial ALS (FALS) and frontotemporal dementia (FTD), 46% of the cases with FALS, and 21% of the cases with sporadic ALS (SALS).<sup>6,7</sup> Therefore, this repeat expansion is currently the most important genetic risk factor for ALS.

In many of our FALS families, we observed apparent autosomal dominant inheritance patterns with evidence for incomplete penetrance. We hypothesized that this phenomenon might be due to polygenic inheritance of ALS. This hypothesis is strengthened by recent reports describing two families with mutations in both *FUS/TLS* and *ANG*, and another patient with an *SOD1* mutation and an *ANG* mutation.<sup>8,9</sup> In search of evidence for polygenic inheritance, we, therefore, sequenced *TARDBP*, *FUS/TLS*, *SOD1*, *ANG*, and *C9orf72* in a cohort of 97 FALS families, as well as in large cohorts of SALS patients and control subjects.

## Patients and methods

### Cases

Samples were collected at national referral centers for ALS in The Netherlands: University Medical Center Utrecht, Academic Medical Center Amsterdam and Radboud University Nijmegen Medical Center. A total of 111 FALS patients (97 different families) was screened for non-synonymous mutations in *TARDBP*, *FUS/TLS*, *SOD1* and *ANG*, and tested for *C9orf72* repeat expansions (Supplementary Table 9.1). In addition, we screened 1,192 SALS patients for mutations in *TARDBP* and *FUS/TLS*. A subgroup of these patients had already been screened for mutations in *SOD1*, *ANG* and *C9orf72*, as described elsewhere.<sup>10-13; Chapter 8 of this thesis</sup> All ALS patients were diagnosed according to the El Escorial criteria.<sup>14,15</sup>

DNA was also obtained from control subjects of Dutch descent, and screened for mutations in *TARDBP* (n = 1,415) and in *SOD1* (n = 1,894). These Dutch control subjects had previously been screened for mutations in *FUS/TLS*, *SOD1*, *ANG*, and *C9orf72*.<sup>10;12;13;Chapter 8 of this thesis</sup> All material was obtained with approval of the Institutional Review Board, and participants provided informed consent.

### Genetic analysis

Subjects were screened for non-synonymous mutations in *TARDBP* (NM\_007375.3), *FUS/TLS* (NM\_004960, exon five, six, fourteen, and fifteen), *SOD1* (NM\_000454), and *ANG* (NM\_001145), as described previously.<sup>10-12;16</sup> Briefly, coding regions were amplified by touchdown PCR with primers in adjacent intronic or non-coding regions. Subsequently, we used BigDye Terminator 3.1 sequencing kit (Applied Biosystems, Foster City, California) and DNA Analyzer 3730XL for sequencing. Data analysis was performed with PolyPhred and identified mutations were confirmed on genomic DNA (at least three times).<sup>17</sup> PMut was used to predict the impact of these mutations on the structure and function of TDP-43 (<http://mmb2.pcb.ub.es:8080/PMut/>). Primers and protocols used to determine hexanucleotide repeat sizes in *C9orf72* (NM\_018325) have been described elsewhere.<sup>Chapter 8 of this thesis</sup>

### Genealogical analysis

In depth genealogical analysis was performed to identify common ancestors of FALS patients. Lists of descendants from index patients were compiled, and thereafter, pedigrees were generated using civil records/registers and church records of the Dutch population.

### Haplotype analysis

To establish further evidence for common ancestry between families, we performed extended haplotype analysis on FALS families and SALS patients with the same mutation (*TARDBP*; p.N352S). For this analysis, we used six extragenic polymorphic markers flanking *TARDBP* (D1S1612, D1S503, D1S244 proximal of *TARDBP*, and D1S2667, D1S2740 and D1S1597 distal of *TARDBP*, Supplementary Figure 9.1). Validity of the constructed haplotype was determined by segregation analysis in families and patients whose DNA was available for testing.

## Statistical analysis

In order to assess whether the observed frequency of samples with multiple mutations was in excess of what one might expect on the basis of chance, we performed a binomial test using the statistical analysis program R (CRAN; <http://www.Rproject.org>). The following formula was used: (pbinom([number of families with multiple mutations], [total number of families], [detected mutation frequency in FALS families multiplied by the detected mutation frequency in control subjects], lower.tail = FALSE, log.p = FALSE)).

## Results

*TARDBP*, *FUS/TLS*, *SOD1*, *ANG*, and *C9orf72* mutations were found in 48% of the FALS families, 8% of the SALS patients, and 0.5% of the control subjects. An overview of the identified mutations is provided in Table 9.1 and in the Supplementary Results. *C9orf72* repeat expansions were most frequently encountered, followed by mutations in *TARDBP*, *FUS/TLS*, *ANG*, and *SOD1*. In five out of 97 families (5.2%) we identified mutations in more than one ALS-associated gene (Table 9.2). Subsequently, we performed a binomial test, which demonstrated that the frequency of families with multiple mutations is higher than expected on the basis of chance (p-value  $1.77 \times 10^{-7}$ ). This result strongly supports a polygenic etiology of ALS. An overview of all pedigrees with multiple mutations is provided in Figures 9.1, 9.2A and 9.3.

The most compelling evidence for polygenic inheritance was seen in patients with a p.N352S mutation in *TARDBP*. This mutation was identified in three apparently SALS patients and in five FALS families; their pedigrees are shown in Figure 9.1 and 9.2. Genealogical analysis showed that one SALS patient (VIII:1) was related to two FALS families, and formed a complex consanguineous pedigree (Pedigree 1, Figure 9.1). The other two SALS patients (VII:1 and VIII:1) were found to be related to a different FALS family (Pedigree 4, Figure 9.2C). Haplotype analysis revealed that all patients with p.N352S in *TARDBP* shared a haplotype surrounding the mutation, which suggests a common ancestor (Supplementary Figure 9.1).

In Pedigree 1 (Figure 9.1), a recombination event (not spanning *TARDBP*) caused the formation of a second haplotype (Supplementary Table 9.2). In this pedigree, we identified five patients with a heterozygous p.N352S mutation, including one SALS patient (VIII:1). Two FALS patients also harbored a *C9orf72* repeat expansion (VIII:5 and VIII:6). The *TARDBP* mutation was transmitted via their unaffected 72-years-old mother (VII:4), and the *C9orf72* repeat expansion via their unaffected 75-years-old father (VII:3). Further-

**Table 9.1** Mutations found in *TARDBP*, *FUS/ITLS*, *SOD1*, *ANG*, and *C9orf72*

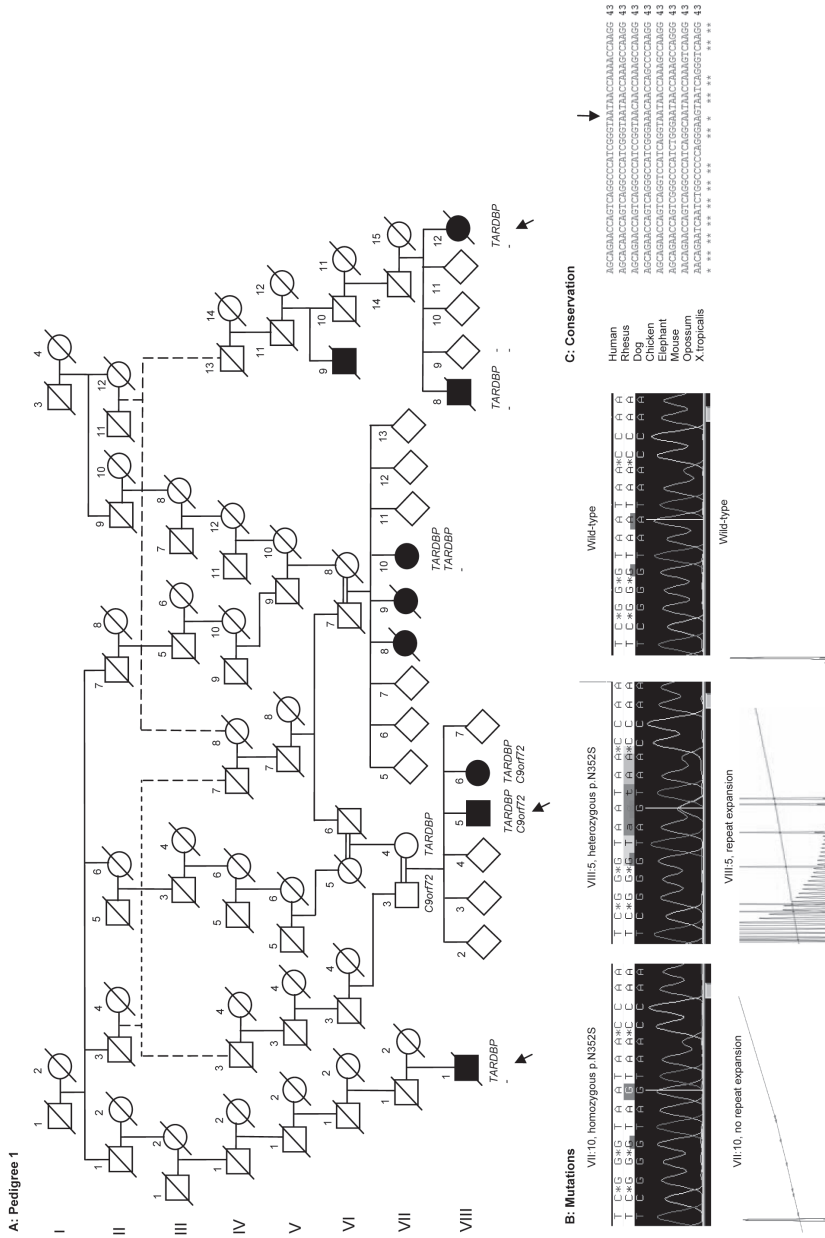
| Gene                      | Mutation                | Exon       | FALS families | SALS           | CON           | Prediction PMut | Novel |
|---------------------------|-------------------------|------------|---------------|----------------|---------------|-----------------|-------|
| <i>TARDBP</i>             | p.A90V                  | 3          | 1/97          | 1/1,192        | 1/1,415       | Pathological    |       |
|                           | p.G295C                 | 6          | 1/97          | 0/1,192        | 0/1,415       | Pathological    | Novel |
|                           | p.N352S                 | 6          | 5/97          | 3/1,192        | 0/1,415       | Pathological    |       |
|                           | p.I383V                 | 6          | 1/97          | 1/1,192        | 0/1,415       | Neutral         |       |
|                           | Total <i>TARDBP</i> (%) |            | 8/97 (8.2)    | 5/1,192 (0.4)  | 1/1,415 (0.1) |                 |       |
| <i>FUS/ITLS</i>           | p.S115N                 | 5          | 0/97          | 1/1,192        | 0/970         | Neutral         | Novel |
|                           | p.Q210H                 | 6          | 1/97          | 0/1,192        | 1/970         | Neutral         |       |
|                           | p.R487C                 | 14         | 0/97          | 1/1,192        | 0/970         | Pathological    | Novel |
|                           | p.R495X                 | 14         | 0/97          | 1/1,192        | 0/970         | N/A             |       |
|                           | p.R521H                 | 15         | 1/97          | 0/1,192        | 0/970         | Pathological    |       |
|                           | p.R521C                 | 15         | 4/97          | 0/1,192        | 0/970         | Pathological    |       |
| Total <i>FUS/ITLS</i> (%) |                         | 6/97 (6.2) | 3/1,192 (0.3) | 1/970 (0.1)    |               |                 |       |
| <i>SOD1</i>               | p.D90A                  | 4          | 1/97          | 1/451          | 3/1,894       | Pathological    |       |
|                           | p.I99V                  | 4          | 0/97          | 1/451          | 0/1,894       | Neutral         |       |
|                           | Total <i>SOD1</i> (%)   |            | 1/97 (1.0)    | 2/451 (0.4)    | 3/1,894 (0.2) |                 |       |
| <i>ANG</i>                | p.G(-10)D               | 2          | 0/97          | 1/941          | 0/1,582       | N/A             |       |
|                           | p.K17I                  | 2          | 2/97          | 3/941          | 2/1,582       | Pathological    |       |
|                           | p.T80S                  | 2          | 0/97          | 1/941          | 0/1,582       | Neutral         |       |
|                           | p.F100I                 | 2          | 0/97          | 1/941          | 0/1,582       | Neutral         |       |
|                           | Total <i>ANG</i> (%)    |            | 2/97 (2.1)    | 6/941 (0.6)    | 2/1,582 (0.1) |                 |       |
| <i>C9orf72</i>            | Long repeat (%)         | N/A        | 35/97 (36)    | 87/1,422 (6.1) | 0/748 (0.0)   | N/A             |       |
|                           | Total (%)               |            | 48            | 8              | 0.5           |                 |       |

Abbreviations: FALS = familial amyotrophic lateral sclerosis, SALS = sporadic amyotrophic lateral sclerosis, CON = control subject, and N/A = not applicable. Mutations in *TARDBP*, *FUS/ITLS*, *SOD1*, *ANG*, and *C9orf72* were present in 48% of the FALS families (51% of the 111 FALS patients), 8% of the SALS patients, and 0.5% of the control subjects.

**Table 9.2** Clinical information on families identified with mutations in multiple ALS-associated genes

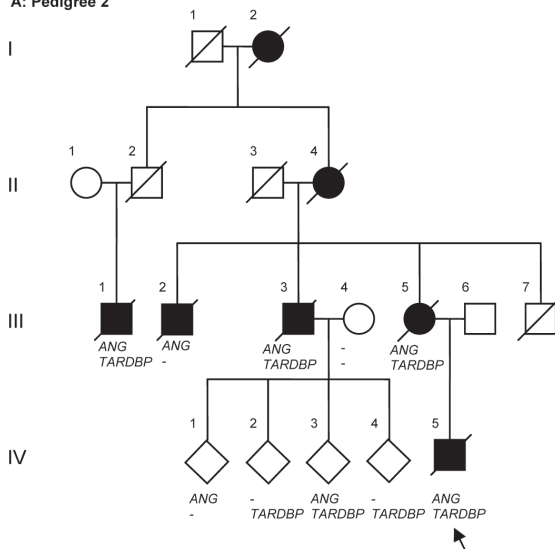
| PED               | ID                  | Gene 1  | Mutation 1 | Haplotype | Gene 2  | Mutation 2  | Gender | Age at onset (y) | Site of onset | Duration (m)    |
|-------------------|---------------------|---------|------------|-----------|---------|-------------|--------|------------------|---------------|-----------------|
| PED1 <sup>a</sup> | VII:10 <sup>g</sup> | TARDBP  | p.N352S    | 1 + 2     | TARDBP  | p.N352S     | F      | 58               | Cervical      | >62             |
|                   | VIII:5              | TARDBP  | p.N352S    | 2         | C9orf72 | Long repeat | M      | 42               | Cervical      | >91             |
|                   | VIII:6              | TARDBP  | p.N352S    | 2         | C9orf72 | Long repeat | F      | 47               | Cervical      | >15             |
|                   | VIII:8              | TARDBP  | p.N352S    | 1         | N/A     | N/A         | M      | 59               | Cervical      | 86 <sup>h</sup> |
|                   | VIII:12             | TARDBP  | p.N352S    | 1         | N/A     | N/A         | F      | 64               | Cervical      | 66 <sup>h</sup> |
| PED2 <sup>b</sup> | III:1               | TARDBP  | p.N352S    | 1         | ANG     | p.K171      | M      | 61               | Cervical      | 8 <sup>h</sup>  |
|                   | III:2 <sup>f</sup>  | No      | No         | No        | ANG     | p.K171      | M      | 74               | Cervical      | 37 <sup>h</sup> |
|                   | III:5               | TARDBP  | p.N352S    | 1         | ANG     | p.K171      | F      | 73               | Lumbosacral   | 47 <sup>h</sup> |
|                   | IV:5                | TARDBP  | p.N352S    | 1         | ANG     | p.K171      | M      | 54               | Cervical      | 52 <sup>h</sup> |
| PED5 <sup>c</sup> | III:6               | SOD1    | p.D90A     | N/A       | C9orf72 | Long repeat | F      | 51               | Cervical      | 77 <sup>h</sup> |
| PED6 <sup>d</sup> | III:5               | FUS/TLS | p.R521C    | N/A       | ANG     | p.K171      | F      | 53               | Lumbosacral   | > 24            |
|                   | III:5               | FUS/TLS | p.Q210H    | N/A       | C9orf72 | Long repeat | M      | 58               | Lumbosacral   | 25 <sup>h</sup> |

Abbreviations: PED = pedigree, ID = identifier in pedigree, F = female, M = male, y = years, and m = months. This table displays all families that were detected with mutations in multiple genes. The pedigree of this family is shown in: <sup>a</sup> Figure 9.1, <sup>b</sup> Figure 9.2A, <sup>c</sup> Figure 9.3A, <sup>d</sup> Figure 9.3B, <sup>e</sup> Figure 9.3C, <sup>f</sup> Patient III:2 presented with parkinsonism; after five years, he developed progressive weakness of the arms and legs with atrophy, fasciculations, and hyperreflexia. He also demonstrated symptoms characteristic of frontotemporal dementia (FTD), <sup>g</sup> Patient VII:10 has a homozygous mutation. <sup>h</sup> Patient is deceased.

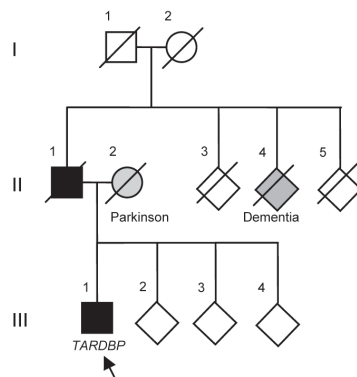


**Figure 9.1** Pedigree 1 with *TARDBP* (p.N352S) mutation. A: Screened individuals with a *TARDBP* mutation (p.N352S) are marked with '*TARDBP*'. Individuals with *C9orf72* repeat expansions are marked with '*C9orf72*', and individuals without these mutations are marked with '-'. B: We show the homozygous p.N352S mutation without a *C9orf72* repeat expansion of patient VIII:10. In addition, we display the heterozygous p.N352S mutation and the *C9orf72* repeat expansion of patient VIII:5. C: Conservation of amino-acid residues across species was generated using ClustalW2 online tool, <http://www.ebi.ac.uk/Tools/msa/clustalw2/>. See Appendix page 383 for Figure 9.1 in color.

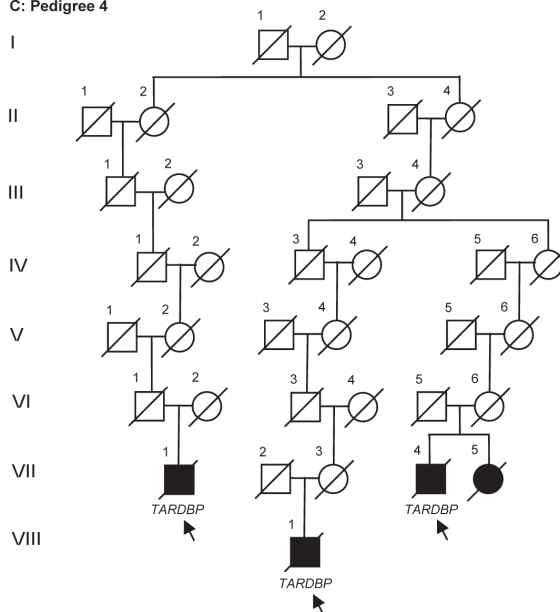
A: Pedigree 2



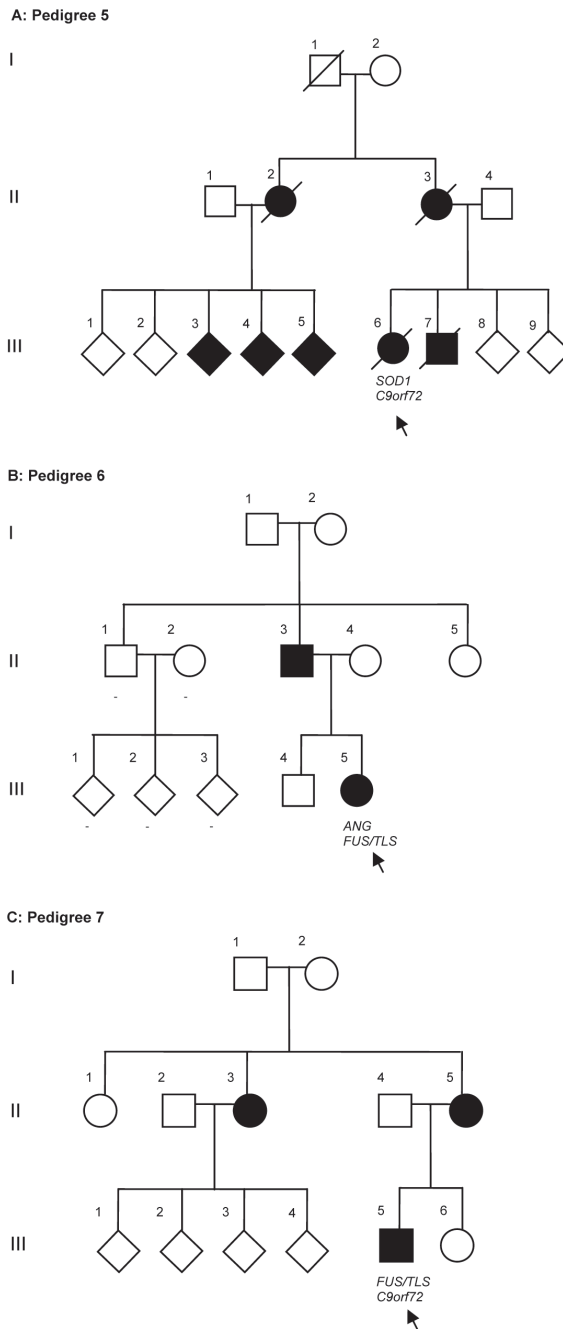
B: Pedigree 3



C: Pedigree 4



**Figure 9.2** Pedigree 2, 3, and 4 with *TARDBP* (p.N352S) mutations. A: Patients III:1,III:5, III:3, and IV:5 have both *TARDBP* (p.N352S) and *ANG* (p.K17I) mutations. For simplicity just part of the pedigree is shown. Screened individuals who did not have a *TARDBP* or *ANG* mutation are marked with '-'. B: Pedigree of additional FALS patient with *TARDBP* (p.N352S) mutation. C: Pedigree of two SALS patients with p.N352S mutations in *TARDBP*, which were distantly related to a FALS patient.



**Figure 9.3** Pedigree 5, 6, 7 with multiple mutations. A: Patient III:6 has both a *SOD1* (p.D90A) mutation and a *C9orf72* repeat expansion. DNA of other family members was not available for testing. B: Patient III:5 has both an *ANG* (p.K17I) mutation and a *FUS/TLN* (p.R521C) mutation. For simplicity just part of the pedigree is shown. C: Patient III:5 has both a *FUS/TLN* (p.Q210H) mutation and a *C9orf72* repeat expansion. DNA of other family members was not available for testing.



more, we detected one patient from a consanguineous marriage with a homozygous p.N352S mutation (VII:10).

In Pedigree 2 (Figure 9.2A), another family is displayed with a p.N352S mutation. In this pedigree, a mutation in *ANG* (p.K17I) co-segregated with ALS.<sup>18</sup> While four patients had both *ANG* and *TARDBP* mutations, one patient (III:2) had an *ANG* mutation without a *TARDBP* mutation. This patient had a somewhat different phenotype compared to his affected family members, since he presented with parkinsonism and also developed FTD and ALS.<sup>11</sup> DNA of patient III:3 was unavailable for testing. His children, aged between 44 and 58 years and currently without neurological complaints, did, however, have *ANG* and/or *TARDBP* mutations (IV:1 to IV:4). In total, we identified fourteen patients with p.N352S mutations, seven of whom (50%) had multiple mutations in ALS-associated genes.

In addition, we identified a *C9orf72* repeat expansion in one patient (III:6) known to have a p.D90A *SOD1* mutation (Pedigree 5).<sup>10</sup> Analysis of her pedigree revealed an autosomal dominant pattern of inheritance, as shown previously (Figure 9.3A).<sup>10</sup> A p.K17I mutation in *ANG* was also identified in a patient (III:5) with a p.R521C *FUS/TLS* mutation (Pedigree 6). DNA testing in ten non-affected family members of patient III:5, failed to detect other subjects with mutations in *FUS/TLS* or *ANG* (Figure 9.3B). Finally, another *C9orf72* repeat expansion was present in a patient (III:5) with a p.Q210H *FUS/TLS* mutation (Pedigree 7, Figure 9.3C). The p.Q210H mutation was also detected in one of our control subjects (Table 9.1).<sup>12</sup>

## Discussion

In this study, we investigated a polygenic model for ALS, by screening *TARDBP*, *FUS/TLS*, *SOD1*, *ANG*, and *C9orf72* for mutations in large cohorts of FALS patients, SALS patients and control subjects. In five out of 97 FALS families, we identified multiple mutations in ALS-associated genes. Statistical analysis demonstrated that the frequency of families with multiple mutations is higher than one might expect on the basis of chance (p-value  $1.77 \times 10^{-7}$ ). The most compelling evidence for a polygenic basis of ALS was found in individuals with a p.N352S mutation in *TARDBP*. This mutation was detected in five FALS families and in three apparently SALS patients. Genealogical analysis suggested that these patients had a common ancestor, something that was supported by the identification of a shared haplotype. In total, DNA was available of fourteen patients with the p.N352S mutation, and we were able to detect a second mutation in 50% of them (*ANG*, *C9orf72* or homozygous *TARDBP*).

To date, mutations in *TARDBP* are considered to cause ALS in an autosomal dominant manner. The p.N352S mutation is predicted to be pathogenic and has not been detected in over 13,000 control subjects (Supplementary Table 9.3). A heterozygous variant was originally reported in a German family.<sup>19</sup> It has also been detected in one FALS patient and one SALS patient of Japanese origin.<sup>20;21</sup> The previously published pedigrees showed incomplete penetrance.<sup>20;21</sup> Our p.N352S pedigrees also demonstrated reduced penetrance, a finding substantiated by the detection of p.N352S in apparently sporadic cases (derived from a common ancestor). In short, our findings suggest that a second mutation is essential for the development of ALS.

We have identified five FALS families with mutations in multiple ALS-associated genes: *FUS/TLS* and *TARDBP* mutations were found in combination with *ANG* mutations, and *C9orf72* repeat expansions with *TARDBP*, *SOD1*, and *FUS/TLS* mutations. The nature of the second mutations provides further evidence for a polygenic etiology of ALS. For instance, *C9orf72* repeat expansions have been reported in families with high penetrance, but also in families with many unaffected carriers.<sup>6;7</sup> This could imply that additional genetic factors contribute to ALS pathogenesis in some *C9orf72* families. Moreover, these factors could also explain why some individuals with *C9orf72* repeat expansions develop ALS, whereas others develop FTD or a combination of ALS and FTD.

The identification of mutations in *ANG* is compatible with a polygenic etiology as well. Although *ANG* mutations were initially thought to be directly pathogenic, later studies also demonstrated *ANG* mutations in control subjects (p.K17I, p.M-21I, p.P-4S and p.I46V).<sup>13;22-25</sup> The p.K17I mutation, however, does affect protein function. For instance, motor neurons transfected with p.K17I, lack the neuroprotective activity against hypoxic exposure shown by wild-type *ANG*.<sup>26</sup> Moreover, wild-type *ANG* induces the formation of human umbilical vein endothelial cell (HUVEC) tubes, whereas p.K17I does not, indicating a complete loss of its angiogenic activity.<sup>27</sup> Furthermore, p.K17I demonstrates 5% of the ribonucleolytic activity of wild-type *ANG*.<sup>27</sup>

Importantly, a large international collaborative study has recently revealed that *ANG* mutations are not directly pathogenic, but that they are a risk factor for ALS, conferring a substantial risk (odds ratio [OR] = 9.2).<sup>13</sup> Interestingly, this study also showed that *ANG* mutations are a risk factor for Parkinson's disease (OR = 6.7).<sup>13</sup> The combination of a genetic risk factor with a large effect (such as an *ANG* mutation) and another mutation with incomplete penetrance, fits the polygenic disease model well. That *ANG* mutations also confer a risk for Parkinson's disease, suggests that multiple genetic factors influence phenotypic characteristics.

Another intriguing double mutation was seen in Pedigree 3, where the p.D90A *SOD1* mutation was observed in combination with a *C9orf72* repeat expansion. The p.D90A mutation is known to cause ALS in both an autosomal dominant and an autosomal recessive manner. In Scandinavia, p.D90A is a relatively common polymorphism in the general population (2.5%) and only homozygous individuals develop ALS. Outside Scandinavia p.D90A seems to cause ALS in an autosomal dominant fashion (it must be noted that autosomal dominant p.D90A pedigrees are rare).<sup>4,10,28-30</sup> This discrepancy has been attributed to a genetic modifier on the Scandinavian haplotype, but this modifier has not yet been identified. An alternative explanation might be that the p.D90A haplotype outside Scandinavia is also recessive, and that ALS co-segregates with a second mutation, as in Pedigree 3.

We also detected a p.K17I *ANG* mutation in a patient with a p.R521C *FUS/TLS* mutation, the most frequent *FUS/TLS* mutation.<sup>8,12,31-43</sup> In another FALS family, we detected a *C9orf72* repeat expansion and a p.Q210H *FUS/TLS* mutation.<sup>12</sup> *FUS/TLS* mutations are considered to cause ALS in an autosomal dominant manner. However, incomplete penetrance is frequently observed, and one of the pedigrees that led to the discovery of *FUS/TLS* demonstrated an autosomal recessive pattern as well.<sup>31</sup> The co-occurrence of *ANG* mutations and *C9orf72* repeat expansions in families with *FUS/TLS* mutations, strongly suggests a complex inheritance of ALS.

SALS is considered to be a complex disease in which multiple environmental and genetic risk factors contribute to disease susceptibility. In this study, we provide evidence for a complex etiology of FALS as well. We propose that the phenotypic variability that is frequently detected within FALS families is due to multiple genetic factors. A polygenic etiology of ALS has important implications for the interpretation of whole exome/genome experiments, aiming at the identification of new ALS-associated genes. Although great progress has recently been made in unraveling the pathogenesis of ALS, our data suggests that many genetic risk factors are yet to be identified.

## Acknowledgements

This work was supported by the VSB fonds, The Brain Foundation of The Netherlands, Prinses Beatrix Fonds, Catharijne Stichting, H. Kersten and M. Kersten, J. R. van Dijk, the Adessium Foundation, and the European Community's Health Seventh Framework Program (FP7/2007-2013) under grant agreement n° 259867.

## References

- (1) McGuire V, Longstreth WT, Jr., Koepsell TD, van BG. Incidence of amyotrophic lateral sclerosis in three counties in western Washington state. *Neurology* 1996;47:571-573.
- (2) Logroscino G, Traynor BJ, Hardiman O et al. Incidence of amyotrophic lateral sclerosis in Europe. *J Neurol Neurosurg Psychiatry* 2010;81:385-390.
- (3) Rowland LP, Shneider NA. Amyotrophic lateral sclerosis. *N Engl J Med* 2001;344:1688-1700.
- (4) Valdmanis PN, Rouleau GA. Genetics of familial amyotrophic lateral sclerosis. *Neurology* 2008;70:144-152.
- (5) Van Damme P, Robberecht W. Recent advances in motor neuron disease. *Curr Opin Neurol* 2009;22:486-492.
- (6) Renton AE, Majounie E, Waite A et al. A Hexanucleotide Repeat Expansion in C9ORF72 Is the Cause of Chromosome 9p21-Linked ALS-FTD. *Neuron* 2011;72:257-268.
- (7) DeJesus-Hernandez M, Mackenzie IR, Boeve BF et al. Expanded GGGGCC Hexanucleotide Repeat in Noncoding Region of C9ORF72 Causes Chromosome 9p-Linked FTD and ALS. *Neuron* 2011;72:245-256.
- (8) Millecamps S, Salachas F, Cazeneuve C et al. SOD1, ANG, VAPB, TARDBP, and FUS mutations in familial amyotrophic lateral sclerosis: genotype-phenotype correlations. *J Med Genet* 2010;47:554-560.
- (9) Luigetti M, Lattante S, Zollino M et al. SOD1 G93D sporadic amyotrophic lateral sclerosis (SALS) patient with rapid progression and concomitant novel ANG variant. *Neurobiol Aging* 2011;32:1924.e15-e18.
- (10) van Es MA, Dahlberg C, Birve A, Veldink JH, van den Berg LH, Andersen PM. Large-scale SOD1 mutation screening provides evidence for genetic heterogeneity in amyotrophic lateral sclerosis. *J Neurol Neurosurg Psychiatry* 2010;81:562-566.
- (11) van Es MA, Diekstra FP, Veldink JH et al. A case of ALS-FTD in a large FALS pedigree with a K17I ANG mutation. *Neurology* 2009;72:287-288.
- (12) Groen EJ, van Es MA, van Vught PW et al. FUS mutations in familial amyotrophic lateral sclerosis in the Netherlands. *Arch Neurol* 2010;67:224-230.
- (13) van Es MA, Schelhaas HJ, van Vught PW et al. Angiogenin variants in Parkinson disease and amyotrophic lateral sclerosis. *Ann Neurol* 2011;70:964-973.
- (14) Brooks BR, Miller RG, Swash M, Munsat TL. El Escorial revisited: revised criteria for the diagnosis of amyotrophic lateral sclerosis. *Amyotroph Lateral Scler Other Motor Neuron Disord* 2000;1:293-299.
- (15) Brooks BR. El Escorial World Federation of Neurology criteria for the diagnosis of amyotrophic lateral sclerosis. Subcommittee on Motor Neuron Diseases/Amyotrophic Lateral Sclerosis of the World Federation of Neurology Research Group on Neuromuscular Diseases and the El Escorial "Clinical limits of amyotrophic lateral sclerosis" workshop contributors. *J Neurol Sci* 1994;124 Suppl:96-107.
- (16) Sreedharan J, Blair IP, Tripathi VB et al. TDP-43 mutations in familial and sporadic amyotrophic lateral sclerosis. *Science* 2008;319:1668-1672.

- (17) Nickerson DA, Tobe VO, Taylor SL. PolyPhred: automating the detection and genotyping of single nucleotide substitutions using fluorescence-based resequencing. *Nucleic Acids Res* 1997;25:2745-2751.
- (18) van Es MA, Diekstra FP, Veldink JH et al. A case of ALS-FTD in a large FALS pedigree with a K17I ANG mutation. *Neurology* 2009;72:287-288.
- (19) Kuhnlein P, Sperfeld AD, Vanmassenhove B et al. Two German kindreds with familial amyotrophic lateral sclerosis due to TARDBP mutations. *Arch Neurol* 2008;65:1185-1189.
- (20) Kamada M, Maruyama H, Tanaka E et al. Screening for TARDBP mutations in Japanese familial amyotrophic lateral sclerosis. *J Neurol Sci* 2009;284:69-71.
- (21) Iida A, Kamei T, Sano M et al. Large-scale screening of TARDBP mutation in amyotrophic lateral sclerosis in Japanese. *Neurobiol Aging* 2012;33:786-790.
- (22) Fernandez-Santiago R, Hoenig S, Lichtner P et al. Identification of novel Angiogenin (ANG) gene missense variants in German patients with amyotrophic lateral sclerosis. *J Neurol* 2009;256:1337-1342.
- (23) Gellera C, Colombrita C, Ticozzi N et al. Identification of new ANG gene mutations in a large cohort of Italian patients with amyotrophic lateral sclerosis. *Neurogenetics* 2008;9:33-40.
- (24) Greenway MJ, Andersen PM, Russ C et al. ANG mutations segregate with familial and 'sporadic' amyotrophic lateral sclerosis. *Nat Genet* 2006;38:411-413.
- (25) Conforti FL, Sprovieri T, Mazzei R et al. A novel Angiogenin gene mutation in a sporadic patient with amyotrophic lateral sclerosis from southern Italy. *Neuromuscul Disord* 2008;18:68-70.
- (26) Sebastia J, Kieran D, Breen B et al. Angiogenin protects motoneurons against hypoxic injury. *Cell Death Differ* 2009;16:1238-1247.
- (27) Wu D, Yu W, Kishikawa H et al. Angiogenin loss-of-function mutations in amyotrophic lateral sclerosis. *Ann Neurol* 2007;62:609-617.
- (28) Giannini F, Battistini S, Mancuso M et al. D90A-SOD1 mutation in ALS: The first report of heterozygous Italian patients and unusual findings. *Amyotroph Lateral Scler* 2010;11:216-219.
- (29) Rabe M, Felbecker A, Waibel S et al. The epidemiology of CuZn-SOD mutations in Germany: a study of 217 families. *J Neurol* 2010;257:1298-1302.
- (30) Andersen PM, Nilsson P, Ala-Hurula V et al. Amyotrophic lateral sclerosis associated with homozygosity for an Asp90Ala mutation in CuZn-superoxide dismutase. *Nat Genet* 1995;10:61-66.
- (31) Kwiatkowski TJ, Jr., Bosco DA, Leclerc AL et al. Mutations in the FUS/TLS gene on chromosome 16 cause familial amyotrophic lateral sclerosis. *Science* 2009;323:1205-1208.
- (32) Vance C, Rogelj B, Hortobagyi T et al. Mutations in FUS, an RNA processing protein, cause familial amyotrophic lateral sclerosis type 6. *Science* 2009;323:1208-1211.
- (33) Belzil VV, Valdmanis PN, Dion PA et al. Mutations in FUS cause FALS and SALS in French and French Canadian populations. *Neurology* 2009;73:1176-1179.

- (34) Drepper C, Herrmann T, Wessig C, Beck M, Sendtner M. C-terminal FUS/TLS mutations in familial and sporadic ALS in Germany. *Neurobiol Aging* 2011;32:548.e1-e4.
- (35) Tateishi T, Hokonohara T, Yamasaki R et al. Multiple system degeneration with basophilic inclusions in Japanese ALS patients with FUS mutation. *Acta Neuropathol* 2010;119:355-364.
- (36) Ticozzi N, Silani V, Leclerc AL et al. Analysis of FUS gene mutation in familial amyotrophic lateral sclerosis within an Italian cohort. *Neurology* 2009;73:1180-1185.
- (37) Syriani E, Morales M, Gamez J. FUS/TLS gene mutations are the second most frequent cause of familial ALS in the Spanish population. *Amyotroph Lateral Scler* 2011;12:118-123.
- (38) Yamamoto-Watanabe Y, Watanabe M, Okamoto K et al. A Japanese ALS6 family with mutation R521C in the FUS/TLS gene: a clinical, pathological and genetic report. *J Neurol Sci* 2010;296:59-63.
- (39) Chio A, Calvo A, Moglia C et al. A de novo missense mutation of the FUS gene in a "true" sporadic ALS case. *Neurobiol Aging* 2011;32:553.e23-e26.
- (40) Lai SL, Abramzon Y, Schymick JC et al. FUS mutations in sporadic amyotrophic lateral sclerosis. *Neurobiol Aging* 2011;32:550.e1-e4.
- (41) Rademakers R, Stewart H, DeJesus-Hernandez M et al. Fus gene mutations in familial and sporadic amyotrophic lateral sclerosis. *Muscle Nerve* 2010;42:170-176.
- (42) Blair IP, Williams KL, Warraich ST et al. FUS mutations in amyotrophic lateral sclerosis: clinical, pathological, neurophysiological and genetic analysis. *J Neurol Neurosurg Psychiatry* 2010;81:639-645.
- (43) Corrado L, Del Bo R, Castellotti B et al. Mutations of FUS gene in sporadic amyotrophic lateral sclerosis. *J Med Genet* 2010;47:190-194.

## SUPPLEMENT

### Supplementary Results

TAR DNA-binding protein (*TARDBP*), fused in sarcoma / translated in liposarcoma (*FUS/TLS*), superoxide dismutase-1 (*SOD1*), angiogenin (*ANG*), and chromosome 9 open reading frame 72 (*C9orf72*) variants accounted for 48% of the FALS families, 8% of the SALS patients, and 0.5% of the control subjects (Table 9.1).

In *TARDBP*, we detected four missense mutations in twelve FALS patients from eight different families (8.2%), five SALS patients (0.4%), and one control subject (0.1%). The p.G295C mutation was novel, and predicted to be pathological. Two other amino acid substitutions at codon 295 have been reported. These substitutions change glycine to serine (p.G295S) or arginine (p.G295R), confirming the critical nature of this residue.<sup>1-3</sup> The most prevalent mutation was the p.N352S mutation (5.2%). Genealogical analysis demonstrated family relationships between patients with this mutation: one SALS patient was distantly related to two FALS families (Pedigree 1, Figure 9.1), and two other SALS patients turned out to be distantly related to another FALS family (Pedigree 4, Figure 9.2C). In addition, haplotype analysis revealed a shared 5.5 Mb haplotype (haplotype 1) surrounding the p.N352S mutation (Supplementary Figure 9.1). This haplotype was detected in eleven ALS patients with p.N352S mutations (Supplementary Table 9.2), which suggests the p.N352S mutation is a founder mutation. Recombination resulted in a second haplotype (haplotype 2); this was only detected in three patients from one family (Pedigree 1).

In *FUS/TLS*, six mutations were present in six FALS families (6.2%), three SALS patients (0.3%), and one control subject (0.1%). We identified two novel mutations: p.S115N and p.R487C. These novel mutations were detected in SALS patients (Supplementary Table 9.2) and located in well conserved regions. The p.S115N mutation was predicted to be benign, whereas the p.R487C mutation was predicted to have pathological effects.

Two mutations in *SOD1* were detected in one FALS family (1.0%), two SALS patients (0.4%), and three control subjects (0.2%), these mutations have been reported previously.<sup>1</sup> Four *ANG* mutations were present in two FALS families (2.1%), six SALS patients (0.6%), and two control subjects (0.1%); these mutations have been reported as well.<sup>2,3</sup> *C9orf72* repeat expansions accounted for 35 FALS families (36%), 87 SALS patients (6%), and none of the control subjects.<sup>Chapter 8 of this thesis</sup>

## Supplementary Tables

**Supplementary Table 9.1** Baseline characteristics of FALS patients

| Group | Number (n) | Male/female (n) (%) | Age at onset (y) (CI) | Spinal/bulbar (n) (%) | Alive/deceased (n) (%) | Duration (y) (CI) |
|-------|------------|---------------------|-----------------------|-----------------------|------------------------|-------------------|
| FALS  | 111        | 58/53 (52/48)       | 59.0 (56.8-61.2)      | 89/22 (80/20)         | 30/81 (27/73)          | 3.9 (3.3-4.5)     |

Abbreviations: FALS = familial amyotrophic lateral sclerosis, n = number, y = years, and CI = 95% confidence interval. Disease duration is defined as the interval between age at onset and age at death, or between age at onset and age last known to be alive.



**Supplementary Table 9.2** Clinical information on ALS patients detected in this study

| Gene 1        | Mutation 1 | Haplotype variant | Gene 2         | Mutation 2          | PED   | ID      | Gender | Group | Age at onset (y) | Site of onset | Duration (m)     |
|---------------|------------|-------------------|----------------|---------------------|-------|---------|--------|-------|------------------|---------------|------------------|
| <i>TARDBP</i> | p.A90V     |                   |                |                     |       |         | M      | SALS  | 72               | Bulbar        | 37 <sup>c</sup>  |
|               | p.A90V     |                   |                |                     | PED8  | IV:3    | F      | FALS  | 72               | Bulbar        | 23 <sup>c</sup>  |
|               | p.G295C    |                   |                |                     | PED9  | II:3    | F      | FALS  | 80               | Bulbar        | 43 <sup>c</sup>  |
|               | p.N352S    | 1 + 2             | <i>TARDBP</i>  | p.N352S             | PED1  | VII:10  | F      | FALS  | 58               | Cervical      | > 62             |
|               | p.N352S    | 2 <sup>b</sup>    | <i>C9orf72</i> | Long repeat         | PED1  | VIII:5  | M      | FALS  | 42               | Cervical      | > 91             |
|               | p.N352S    | 2                 | <i>C9orf72</i> | Long repeat         | PED1  | VIII:6  | F      | FALS  | 47               | Cervical      | > 15             |
|               | p.N352S    | 1 <sup>b</sup>    |                |                     | PED1  | VIII:8  | M      | FALS  | 59               | Cervical      | 86 <sup>c</sup>  |
|               | p.N352S    | 1 <sup>b</sup>    |                |                     | PED1  | VIII:12 | F      | FALS  | 64               | Cervical      | 66 <sup>c</sup>  |
|               | p.N352S    | 1                 |                |                     | PED1  | VIII:1  | M      | SALS  | 42               | Cervical      | 58 <sup>c</sup>  |
|               | p.N352S    | 1                 | <i>ANG</i>     | p.K171 <sup>a</sup> | PED2  | III:1   | M      | FALS  | 61               | Cervical      | 8 <sup>c</sup>   |
|               | p.N352S    | 1                 | <i>ANG</i>     | p.K171 <sup>a</sup> | PED2  | III:5   | F      | FALS  | 73               | Lumbosacral   | 47 <sup>c</sup>  |
|               | p.N352S    | 1                 | <i>ANG</i>     | p.K171 <sup>a</sup> | PED2  | IV:5    | M      | FALS  | 54               | Cervical      | 52 <sup>c</sup>  |
|               | No         | No                | <i>ANG</i>     | p.K171 <sup>a</sup> | PED2  | III:2   | M      | FALS  | 74               | Cervical      | 37 <sup>c</sup>  |
|               | p.N352S    | 1 <sup>b</sup>    |                |                     | PED3  | III:1   | M      | FALS  | 49               | Cervical      | > 75             |
|               | p.N352S    | 1 <sup>b</sup>    |                |                     | PED4  | VII:1   | M      | SALS  | 51               | Lumbosacral   | 78 <sup>c</sup>  |
|               | p.N352S    | 1 <sup>b</sup>    |                |                     | PED4  | VIII:1  | M      | SALS  | 53               | Cervical      | 180 <sup>c</sup> |
|               | p.N352S    | 1 <sup>b</sup>    |                |                     | PED4  | VII:4   | M      | FALS  | 76               | Cervical      | 13 <sup>c</sup>  |
|               | p.I383V    |                   |                |                     |       |         | F      | SALS  | 59               | Lumbosacral   | > 103            |
|               | p.I383V    |                   |                |                     | PED10 | III:1   | M      | FALS  | 46               | Lumbosacral   | 64 <sup>c</sup>  |

Supplementary Table 9.2 continues on next page



**Supplementary Table 9.2** *Continued*

| Gene 1         | Mutation 1           | Haplotype variant | Gene 2         | Mutation 2  | PED   | ID    | Gender | Group | Age at onset (y) | Site of onset | Duration (m)    |
|----------------|----------------------|-------------------|----------------|-------------|-------|-------|--------|-------|------------------|---------------|-----------------|
| <i>FUS/TLS</i> | p.S115N              |                   |                |             |       |       | M      | SALS  | 60               | Cervical      | 27 <sup>c</sup> |
|                | p.Q210H <sup>a</sup> |                   | <i>C9orf72</i> | Long repeat | PED7  | III:5 | M      | FALS  | 58               | Lumbosacral   | 25 <sup>c</sup> |
|                | p.R487C              |                   |                |             |       |       | M      | SALS  | 80               | Lumbosacral   | 36 <sup>c</sup> |
|                | p.R495X              |                   |                |             |       |       | F      | SALS  | 19               | Bulbar        | 24 <sup>c</sup> |
|                | p.R521H <sup>a</sup> |                   |                |             |       |       | M      | FALS  | 39               | Cervical      | 12 <sup>c</sup> |
|                | p.R521C <sup>a</sup> |                   |                |             |       |       | M      | FALS  | 29               | Lumbosacral   | 33 <sup>c</sup> |
|                | p.R521C <sup>a</sup> |                   |                |             |       |       | M      | FALS  | 36               | Cervical      | 17 <sup>c</sup> |
| <i>SOD1</i>    | p.R521C              |                   |                |             | PED11 | III:3 | F      | FALS  | 33               | Cervical      | > 11            |
|                | p.R521C              |                   | <i>ANG</i>     | p.K171      | PED6  | III:5 | F      | FALS  | 53               | Lumbosacral   | > 24            |
|                | p.D90A <sup>a</sup>  |                   | <i>C9orf72</i> | Long repeat | PED5  | III:6 | F      | FALS  | 51               | Cervical      | 77 <sup>c</sup> |
|                |                      |                   |                |             |       |       |        |       |                  |               |                 |

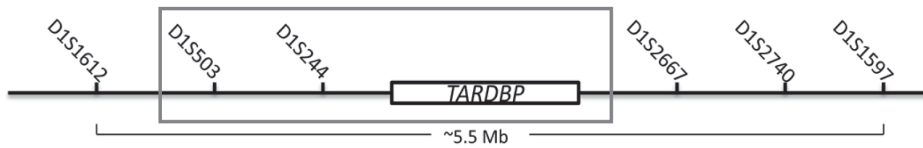
Abbreviations: SALS = sporadic amyotrophic lateral sclerosis, FALS = familial amyotrophic lateral sclerosis, PED = pedigree, M = male, and F = female, ID = identifier in pedigree, and m = months. <sup>a</sup> Reported previously. <sup>b24</sup> Seven patients showed recombination events for the distal markers of this haplotype, confirming the ancient origin of the p.N352S mutation. <sup>c</sup> Patient is deceased.

**Supplementary Table 9.3** SALS patients, FALS patients and control subjects screened for *TARDBP* mutations in exon six

| Article                         | SALS         | FALS         | Control       |
|---------------------------------|--------------|--------------|---------------|
| Benajiba, 2009 <sup>5</sup>     | 71           | 78           | 400           |
| Corrado, 2009 <sup>6</sup>      | 531          | 125          | 771           |
| Del Bo, 2009 <sup>7</sup>       | 298          | 16           | 181           |
| Millecamps, 2010 <sup>8</sup>   | -            | 162          | 500           |
| Kabashi, 2008 <sup>9</sup>      | 120          | 80           | 360           |
| Kirby, 2010 <sup>10</sup>       | 474          | 42           | 499           |
| Origone, 2010 <sup>11</sup>     | 27           | 20           | 158           |
| Chio, 2010 <sup>12</sup>        | -            | 36           | 280           |
| Chio, 2011 <sup>13</sup>        | 104          | 31           | 156           |
| Conforti, 2011 <sup>14</sup>    | 298          | 12           | 150           |
| Williams, 2009 <sup>15</sup>    | 74           | 30           | 354           |
| Sreedharan, 2008 <sup>16</sup>  | 372          | 154          | 1,262         |
| Ticozzi, 2011 <sup>17</sup>     | 188          | 208          | -             |
| Rutherford, 2008 <sup>18</sup>  | 676          | 92           | 825           |
| Tamaoka, 2010 <sup>19</sup>     | -            | 1            | -             |
| Tsaj, 2011 <sup>20</sup>        | -            | 15           | 300           |
| Daoud, 2009 <sup>21</sup>       | 285          | -            | 360           |
| Kuhnlein, 2008 <sup>22</sup>    | 134          | 31           | 400           |
| Gitcho, 2008 <sup>23</sup>      | -            | 8            | 1,505         |
| Guerreiro, 2008 <sup>24</sup>   | 279          | -            | 806           |
| Kamada, 2009 <sup>25</sup>      | 220          | 30           | 105           |
| Iida, 2012 <sup>26</sup>        | 700          | 21           | 732           |
| Baumer, 2009 <sup>27</sup>      | 113          | 15           | -             |
| Van Deerlin, 2008 <sup>28</sup> | 86           | 65           | 1,127         |
| Nozaki, 2010 <sup>29</sup>      | -            | 1            | -             |
| Xiong, 2010 <sup>30</sup>       | 71           | 5            | 200           |
| Yokoseki, 2008 <sup>31</sup>    | 112          | 16           | 267           |
| Lemmens, 2009 <sup>32</sup>     | -            | 20           | 601           |
| Huang, 2010 <sup>33</sup>       | 165          | -            | 400           |
| Luquin, 2009 <sup>34</sup>      | 46           | -            | 115           |
| Gijselinck, 2009 <sup>35</sup>  | 237          | -            | 459           |
| <b>Total (31)</b>               | <b>5,681</b> | <b>1,314</b> | <b>13,273</b> |

Thirty-one articles published on *TARDBP* mutations in ALS patients. Exon six has been analyzed in 5,681 SALS patients, 1,314 FALS patients and 13,273 control subjects. Missense mutations in exon six have been detected in 62 out of 5,681 SALS patients (1.1%), 73 out of 1,314 FALS patients (5.6%), and zero out of 13,273 control subjects (0.0%).

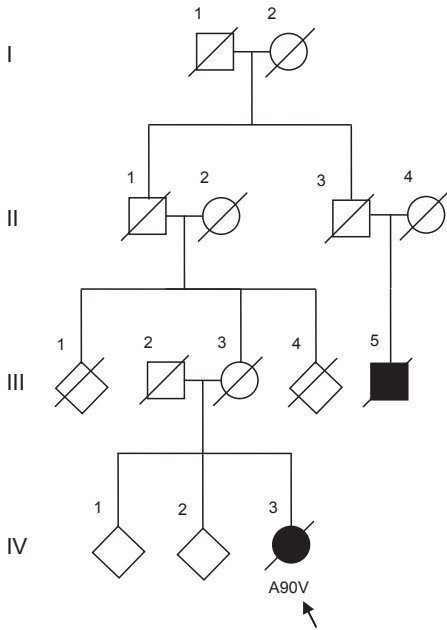
## Supplementary Figures



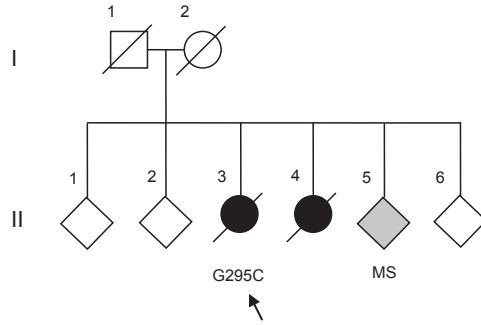
| Marker   | Haplotype 1 | Haplotype 2 |
|----------|-------------|-------------|
| D1S1612  | 92          | 112         |
| D1S503   | 204         | 204         |
| D1S233   | 284         | 284         |
| Mutation | X           | X           |
| D1S2667  | 266         | 250         |
| D1S2740  | 84          | 84          |
| D1S1597  | 170         | 158         |

**Supplementary Figure 9.1** Schematic representation of the *TARDBP* gene on the short arm of chromosome one (1p36.22). Shown are the six polymorphic markers which were used for haplotype analysis, and the two haplotypes that were detected in patients with p.N352S mutations.

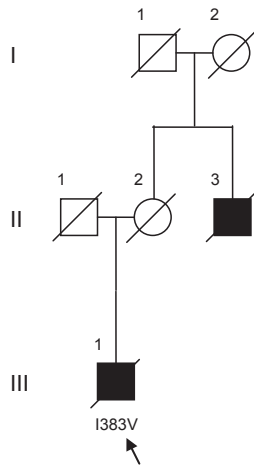
A: Pedigree 8



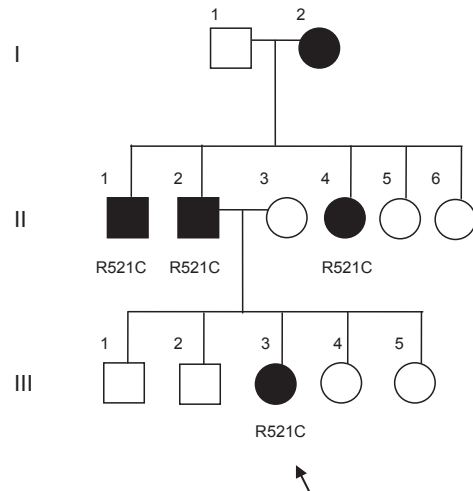
B: Pedigree 9



C: Pedigree 10



D: Pedigree 11



**Supplementary Figure 9.2** Pedigree 8, Pedigree 9, Pedigree 10 with *TARDBP* mutations, and Pedigree 11 with a *FUS/TLN1* mutation. The parents of patient IV:3 died at an early age (41- and 31-years-old).

## Supplementary References

- (1) van Es MA, Dahlberg C, Birve A, Veldink JH, van den Berg LH, Andersen PM. Large-scale SOD1 mutation screening provides evidence for genetic heterogeneity in amyotrophic lateral sclerosis. *J Neurol Neurosurg Psychiatry* 2010;81:562-566.
- (2) van Es MA, Diekstra FP, Veldink JH et al. A case of ALS-FTD in a large FALS pedigree with a K17I ANG mutation. *Neurology* 2009;72:287-288.
- (3) van Es MA, Schelhaas HJ, van Vught PW et al. Angiogenin variants in Parkinson disease and amyotrophic lateral sclerosis. *Ann Neurol* 2011;70:964-973.
- (4) Groen EJ, van Es MA, van Vught PW et al. FUS mutations in familial amyotrophic lateral sclerosis in the Netherlands. *Arch Neurol* 2010;67:224-230.
- (5) Benajiba L, Le Ber I, Camuzat A et al. TARDBP mutations in motoneuron disease with frontotemporal lobar degeneration. *Ann Neurol* 2009;65:470-473.
- (6) Corrado L, Ratti A, Gellera C et al. High frequency of TARDBP gene mutations in Italian patients with amyotrophic lateral sclerosis. *Hum Mutat* 2009;30:688-694.
- (7) Del Bo R, Ghezzi S, Corti S et al. TARDBP (TDP-43) sequence analysis in patients with familial and sporadic ALS: identification of two novel mutations. *Eur J Neurol* 2009;16:727-732.
- (8) Millecamps S, Salachas F, Cazeneuve C et al. SOD1, ANG, VAPB, TARDBP, and FUS mutations in familial amyotrophic lateral sclerosis: genotype-phenotype correlations. *J Med Genet* 2010;47:554-560.
- (9) Kabashi E, Valdmanis PN, Dion P et al. TARDBP mutations in individuals with sporadic and familial amyotrophic lateral sclerosis. *Nat Genet* 2008;40:572-574.
- (10) Kirby J, Goodall EF, Smith W et al. Broad clinical phenotypes associated with TAR-DNA binding protein (TARDBP) mutations in amyotrophic lateral sclerosis. *Neurogenetics* 2010;11:217-225.
- (11) Origone P, Caponnetto C, Bandettini Di Poggio M et al. Enlarging clinical spectrum of FALS with TARDBP gene mutations: S393L variant in an Italian family showing phenotypic variability and relevance for genetic counselling. *Amyotroph Lateral Scler* 2010;11:223-227.
- (12) Chio A, Calvo A, Moglia C et al. Amyotrophic lateral sclerosis-frontotemporal lobar dementia in 3 families with p.Ala382Thr TARDBP mutations. *Arch Neurol* 2010;67:1002-1009.
- (13) Chio A, Borghero G, Pugliatti M et al. Large Proportion of Amyotrophic Lateral Sclerosis Cases in Sardinia Due to a Single Founder Mutation of the TARDBP Gene. *Arch Neurol* 2011;68:594-598.
- (14) Conforti FL, Sproviero W, Simone IL et al. TARDBP gene mutations in south Italian patients with amyotrophic lateral sclerosis. *J Neurol Neurosurg Psychiatry* 2011;82:587-588.
- (15) Williams KL, Durnall JC, Thoeng AD, Warraich ST, Nicholson GA, Blair IP. A novel TARDBP mutation in an Australian amyotrophic lateral sclerosis kindred. *J Neurol Neurosurg Psychiatry* 2009;80:1286-1288.
- (16) Sreedharan J, Blair IP, Tripathi VB et al. TDP-43 mutations in familial and sporadic amyotrophic lateral sclerosis. *Science* 2008;319:1668-1672.

- (17) Ticozzi N, Leclerc AL, van Blitterswijk M et al. Mutational analysis of TARDBP in neurodegenerative diseases. *Neurobiol Aging* 2011;32:2096-2099.
- (18) Rutherford NJ, Zhang YJ, Baker M et al. Novel mutations in TARDBP (TDP-43) in patients with familial amyotrophic lateral sclerosis. *PLoS Genet* 2008;4:e1000193.
- (19) Tamaoka A, Arai M, Itokawa M et al. TDP-43 M337V mutation in familial amyotrophic lateral sclerosis in Japan. *Intern Med* 2010;49:331-334.
- (20) Tsai CP, Soong BW, Lin KP, Tu PH, Lin JL, Lee YC. FUS, TARDBP, and SOD1 mutations in a Taiwanese cohort with familial ALS. *Neurobiol Aging* 2011;32:533.e13-e21.
- (21) Daoud H, Valdmanis PN, Kabashi E et al. Contribution of TARDBP mutations to sporadic amyotrophic lateral sclerosis. *J Med Genet* 2009;46:112-114.
- (22) Kuhnlein P, Sperfeld AD, Vanmassenhove B et al. Two German kindreds with familial amyotrophic lateral sclerosis due to TARDBP mutations. *Arch Neurol* 2008;65:1185-1189.
- (23) Gitcho MA, Baloh RH, Chakraverty S et al. TDP-43 A315T mutation in familial motor neuron disease. *Ann Neurol* 2008;63:535-538.
- (24) Guerreiro RJ, Schymick JC, Crews C, Singleton A, Hardy J, Traynor BJ. TDP-43 is not a common cause of sporadic amyotrophic lateral sclerosis. *PLoS One* 2008;3:e2450.
- (25) Kamada M, Maruyama H, Tanaka E et al. Screening for TARDBP mutations in Japanese familial amyotrophic lateral sclerosis. *J Neurol Sci* 2009;284:69-71.
- (26) Iida A, Kamei T, Sano M et al. Large-scale screening of TARDBP mutation in amyotrophic lateral sclerosis in Japanese. *Neurobiol Aging* 2012;33:786-790.
- (27) Baumer D, Parkinson N, Talbot K. TARDBP in amyotrophic lateral sclerosis: identification of a novel variant but absence of copy number variation. *J Neurol Neurosurg Psychiatry* 2009;80:1283-1285.
- (28) Van Deerlin VM, Leverenz JB, Bekris LM et al. TARDBP mutations in amyotrophic lateral sclerosis with TDP-43 neuropathology: a genetic and histopathological analysis. *Lancet Neurol* 2008;7:409-416.
- (29) Nozaki I, Arai M, Takahashi K et al. Familial ALS with G298S mutation in TARDBP: a comparison of CSF tau protein levels with those in sporadic ALS. *Intern Med* 2010;49:1209-1212.
- (30) Xiong HL, Wang JY, Sun YM et al. Association between novel TARDBP mutations and Chinese patients with amyotrophic lateral sclerosis. *BMC Med Genet* 2010;11:8.
- (31) Yokoseki A, Shiga A, Tan CF et al. TDP-43 mutation in familial amyotrophic lateral sclerosis. *Ann Neurol* 2008;63:538-542.
- (32) Lemmens R, Race V, Hersmus N et al. TDP-43 M311V mutation in familial amyotrophic lateral sclerosis. *J Neurol Neurosurg Psychiatry* 2009;80:354-355.
- (33) Huang R, Fang DF, Ma MY et al. TARDBP gene mutations among Chinese patients with sporadic amyotrophic lateral sclerosis. *Neurobiol Aging* 2010 Aug 12.

- (34) Luquin N, Yu B, Saunderson RB, Trent RJ, Pamphlett R. Genetic variants in the promoter of TARDBP in sporadic amyotrophic lateral sclerosis. *Neuromuscul Disord* 2009;19:696-700.
- (35) Gijssels I, Sleegers K, Engelborghs S et al. Neuronal inclusion protein TDP-43 has no primary genetic role in FTD and ALS. *Neurobiol Aging* 2009;30:1329-1331.



# 9

# 10

**“Only for brief moments did the fear shoot through me that an idea this good could be wrong.”**

James D. Watson, *The Double Helix*.

# ***VAPB* and *C9orf72* mutations in one familial amyotrophic lateral sclerosis patient**

Marka van Blitterswijk, Michael A. van Es, Max Koppers, Wouter van Rheenen,  
Jelena Medic, Helenius J. Schelhaas, Anneke J. van der Kooi, Marianne de Visser,  
Jan H. Veldink, Leonard H. van den Berg

Submitted for publication.

## Abstract

Previously, we have reported amyotrophic lateral sclerosis (ALS) families with multiple mutations in major ALS-associated genes. These findings provided evidence for a polygenic basis of ALS. In our present study, we screened a cohort of 755 sporadic ALS patients, 111 familial ALS patients (97 families), and 765 control subjects of Dutch descent for mutations in vesicle-associated membrane protein B (*VAPB*). We have identified one novel *VAPB* mutation (p.V234I) in a familial ALS patient known to have a chromosome 9 open reading frame 72 (*C9orf72*) repeat expansion. This p.V234I mutation was absent in control subjects, located in a region with high evolutionary conservation, and predicted to have damaging effects. Taken together, these findings provide additional evidence for a polygenic basis of ALS.

## Introduction

Amyotrophic lateral sclerosis (ALS) is a complex neurodegenerative disorder of upper and lower motor neurons. Recently, we screened 97 families with familial ALS (FALS) for mutations in TAR DNA-binding protein (*TARDBP*), fused in sarcoma / translated in liposarcoma (*FUS/TLS*), superoxide dismutase-1 (*SOD1*), angiogenin (*ANG*), and chromosome 9 open reading frame 72 (*C9orf72*). In five of these families (5.2%) we identified multiple mutations, which is higher than one might expect on the basis of chance ( $p\text{-value } 1.77 \times 10^{-7}$ ). We demonstrated that *C9orf72* repeat expansions were combined with *TARDBP*, *FUS/TLS*, and *SOD1* mutations, and that *ANG* mutations were also combined with *TARDBP* and *FUS/TLS* mutations. These findings supported a polygenic etiology of ALS.

In our cohort of FALS patients, we had not yet determined the mutation frequency of vesicle-associated membrane protein B (*VAPB*). A mutation in *VAPB* (p.P56S) was initially reported in Brazilian families with motor neuron disease (MND).<sup>1</sup> These families demonstrated a wide range of phenotypes: their age at onset varied from 25 to 55 years of age, their disease progression from two to thirty years, and they were diagnosed with late-onset spinal muscular atrophy (SMA), atypical ALS or typical ALS.<sup>1</sup> Moreover, several patients were also described with autonomic abnormalities, including chronic intestinal constipation, and sexual dysfunction.<sup>2</sup> Subsequently, this mutation has been described in patients of Brazilian-, Japanese- and European origin.<sup>3-5</sup> Recently, a second missense mutation in *VAPB* (p.T46I) was identified in a cohort of FALS patients from the United Kingdom.<sup>6</sup> We investigated the mutation frequency of *VAPB* mutations in a well-genotyped cohort of ALS patients and control subjects of Dutch descent.

10

## Materials and methods

The study population consisted of 755 patients with sporadic ALS (SALS) and 111 patients with FALS (from 97 different families). All patients were seen at national referral centers for neuromuscular diseases (University Medical Center Utrecht, Academic Medical Center Amsterdam, and Radboud University Nijmegen Medical Center) and diagnosed with ALS according to the El Escorial Criteria.<sup>7</sup> Their baseline characteristics are shown in Supplementary Table 10.1. We also included 765 control subjects of Dutch descent. Patient material was obtained with approval of the Institutional Review Board, and participants gave informed consent. All FALS patients, and large cohorts of SALS patients and control subjects, had been screened for mutations in *TARDBP*, *FUS/TLS*, *SOD1*, *ANG* and *C9orf72*.<sup>Chapter 9 of this thesis</sup>

We screened coding regions of *VAPB* (NM\_004738) for mutations. Previously described primers were used for amplification by touchdown PCR.<sup>6</sup> For sequencing and data analysis BigDye Terminator 3.1 sequencing kit (Applied Biosystems, Foster City, California), DNA Analyzer 3730XL and PolyPhred were used.<sup>8</sup> We confirmed mutations on genomic DNA, and used PolyPhen-2 to predict the impact of these mutations on the structure and function of *VAPB* (<http://genetics.bwh.harvard.edu/pph2/>). PolyPhen-2 values were also used for the variable-threshold test to analyze grouped mutations.<sup>9</sup> This statistical test increases statistical power, and uses a threshold that separates mutations that are likely to be detrimental or non-detrimental. The program R was used to perform this statistical analysis (CRAN; <http://www.Rproject.org>).

## Results

In our Dutch cohort we identified *VAPB* variants in 3.1% of the FALS families, 1.5% of the SALS patients and 1.4% of the control subjects (Table 10.1). The variable-threshold test displayed that there was no significant difference in mutational burden between patients and control subjects, no matter whether we took potential damaging effects of mutations into account (p-value 0.49) or not (p-value 0.53).

We used PolyPhen-2 to predict the effects of these *VAPB* variants, and demonstrated that p.S158N and p.V234I could have damaging effects (Table 10.1). Since p.S158N was also detected in one control subject, this variant most likely represents a benign rare

**Table 10.1** Variants found in *VAPB*

| Variant                | Exon     | FALS families<br>(n = 97)   | SALS<br>(n = 755) | CON<br>(n = 765) | Prediction<br>PolyPhen-2 |
|------------------------|----------|-----------------------------|-------------------|------------------|--------------------------|
| p.A104T                | 3        | 0 (0.0%)                    | 0 (0.0%)          | 1 (0.1%)         | Benign                   |
| p.D130E <sup>a</sup>   | 4        | 0 (0.0%)                    | 1 (0.1%)          | 0 (0.0%)         | Benign                   |
| p.S158N                | 5        | 1 (1.0%)                    | 0 (0.0%)          | 1 (0.1%)         | Possibly damaging        |
| p.S160del <sup>a</sup> | 5        | 1 (1.0%)                    | 5 (0.7%)          | 4 (0.5%)         | Not applicable           |
| p.M170I                | 5        | 0 (0.0%)                    | 5 (0.7%)          | 5 (0.7%)         | Benign                   |
| <b>p.V234I</b>         | <b>6</b> | <b>1 (1.0%)<sup>b</sup></b> | <b>0 (0.0%)</b>   | <b>0 (0.0%)</b>  | <b>Possibly damaging</b> |
| Total                  |          | 3 (3.1%)                    | 11 (1.5%)         | 11 (1.4%)        |                          |

Abbreviations: FALS = familial amyotrophic lateral sclerosis, SALS = sporadic amyotrophic lateral sclerosis, CON = control subjects, and n = number. The impact of missense variants on the structure, and function of the protein was predicted with PolyPhen-2 (<http://genetics.bwh.harvard.edu/pph2/>). <sup>a</sup> The p.S160del and p.D130E variants have been reported previously, both were detected in patients and control subjects.<sup>5,16</sup> <sup>b</sup> This patient also has a *C9orf72* repeat expansion.

polymorphism; p.V234I, on the other hand, was not detected in control subjects. The pathogenicity estimate of the p.V234I mutation was 0.79 (values above 0.5 indicate pathogenicity) with a sensitivity of 0.85 and specificity of 0.93. Moreover, it is located in a region that is highly conserved across species, and appears to cause small changes to  $\alpha$ -helices located within the VAPB protein (Supplementary Figure 10.1). This VAPB mutation was detected in a patient that also harbored a *C9orf72* repeat expansion. She developed weakness in her right leg at 65 years of age, without signs of frontotemporal dementia (FTD), and died after 34 months (Supplementary Table 10.2). Her mother, uncle and grandmother had also died of ALS (Supplementary Figure 10.2). None of her family members had been diagnosed with FTD.

## Discussion

Our study identified one novel VAPB mutation (p.V234I) that was absent in control subjects, located in a region with high evolutionary conservation, and predicted to be pathogenic. The p.V234I mutation was present in one FALS patient, which also harbored a *C9orf72* repeat expansion. This repeat expansion has recently been identified as the most common genetic cause of ALS.<sup>10,11</sup> We have already reported that *C9orf72* repeat expansions can be detected in 37% of the FALS families in The Netherlands.<sup>Chapter 8 of this thesis</sup> In addition, we have shown that these repeat expansions can be identified in FALS patients with *TARDBP*, *FUS/TLS* or *SOD1* mutations.<sup>Chapter 9 of this thesis</sup> Our present study demonstrates that *C9orf72* repeat expansions can be detected in patients with VAPB mutations as well.

Currently, only two pathogenic VAPB mutations have been reported. The first mutation, p.P56S, was identified in MND families with phenotypic heterogeneity.<sup>1</sup> The second mutation, p.T46I, was recently detected in one FALS patient from the United Kingdom.<sup>6</sup> VAPB has three conserved domains: an N-terminal immunoglobulin-like  $\beta$ -sheet that resembles the nematode major sperm protein (MSP, amino acid 1-125) and contains a FFAT (double phenylalanine in an acidic tract), a central coiled-coil domain (CCD, amino acid 158-211), and a C-terminal transmembrane domain (TMD, amino acids 220-243).<sup>12</sup> The p.P56S and p.T46I mutations are both located within the MSP; the p.V234I mutation is located in the TMD. VAPB is known to be involved many cellular processes, including lipid metabolism, membrane trafficking, the unfolded protein response (UPR), microtubule organization, and homeostatic- and stress signaling systems in the endoplasmic reticulum (ER).<sup>12-14</sup> Mutations in VAPB have already been shown to cause cytoplasmic TDP-43 accumulations, lead to ER disorganization, and increase the vulnerability of motor neuron cells to ER stress-induced death.<sup>6,15</sup>

In our present study, we report a novel VAPB mutation in a patient with a C9orf72 repeat expansion. This repeat expansion has previously been reported in patients with a range of clinical phenotypes, including FTD, ALS, ALS-FTD and progressive muscular atrophy (PMA).<sup>10;11;Chapter 8 of this thesis</sup> VAPB mutations have been detected in patients with phenotypic heterogeneity as well.<sup>1</sup>We, therefore, hypothesize that these phenotypic differences can be attributed to interactions between ALS-associated genes, emphasizing the complex polygenic etiology of neurodegenerative diseases.

## Acknowledgements

This work was supported by the VSB fonds, The Brain Foundation of The Netherlands, Prinses Beatrix Fonds, Catharijne Stichting, H. Kersten and M. Kersten, J. R. van Dijk, the Adessium Foundation, and European Community's Health Seventh Framework Program (FP7/2007-2013) under grant agreement n° 259867.

## References

- (1) Nishimura AL, Mitne-Neto M, Silva HC et al. A mutation in the vesicle-trafficking protein VAPB causes late-onset spinal muscular atrophy and amyotrophic lateral sclerosis. *Am J Hum Genet* 2004;75:822-831.
- (2) Marques VD, Barreira AA, Davis MB et al. Expanding the phenotypes of the Pro56Ser VAPB mutation: proximal SMA with dysautonomia. *Muscle Nerve* 2006;34:731-739.
- (3) Millecamps S, Salachas F, Cazeneuve C et al. SOD1, ANG, VAPB, TARDBP, and FUS mutations in familial amyotrophic lateral sclerosis: genotype-phenotype correlations. *J Med Genet* 2010;47:554-560.
- (4) Funke AD, Esser M, Kruttgen A et al. The p.P56S mutation in the VAPB gene is not due to a single founder: the first European case. *Clin Genet* 2010;77:302-303.
- (5) Landers JE, Leclerc AL, Shi L et al. New VAPB deletion variant and exclusion of VAPB mutations in familial ALS. *Neurology* 2008;70:1179-1185.
- (6) Chen HJ, Anagnostou G, Chai A et al. Characterization of the properties of a novel mutation in VAPB in familial amyotrophic lateral sclerosis. *J Biol Chem* 2010;285:40266-40281.
- (7) Brooks BR, Miller RG, Swash M, Munsat TL. El Escorial revisited: revised criteria for the diagnosis of amyotrophic lateral sclerosis. *Amyotroph Lateral Scler Other Motor Neuron Disord* 2000;1:293-299.
- (8) Nickerson DA, Tobe VO, Taylor SL. PolyPhred: automating the detection and genotyping of single nucleotide substitutions using fluorescence-based resequencing. *Nucleic Acids Res* 1997;25:2745-2751.
- (9) Price AL, Kryukov GV, de Bakker PI et al. Pooled association tests for rare variants in exon-resequencing studies. *Am J Hum Genet* 2010;86:832-838.



- (10) Renton AE, Majounie E, Waite A et al. A Hexanucleotide Repeat Expansion in C9ORF72 Is the Cause of Chromosome 9p21-Linked ALS-FTD. *Neuron* 2011;72:257-268.
- (11) DeJesus-Hernandez M, Mackenzie IR, Boeve BF et al. Expanded GGGGCC Hexanucleotide Repeat in Noncoding Region of C9ORF72 Causes Chromosome 9p-Linked FTD and ALS. *Neuron* 2011;72:245-256.
- (12) Lev S, Ben HD, Peretti D, Dahan N. The VAP protein family: from cellular functions to motor neuron disease. *Trends Cell Biol* 2008;18:282-290.
- (13) Kanekura K, Suzuki H, Aiso S, Matsuoka M. ER stress and unfolded protein response in amyotrophic lateral sclerosis. *Mol Neurobiol* 2009;39:81-89.
- (14) Gkogkas C, Middleton S, Kremer AM et al. VAPB interacts with and modulates the activity of ATF6. *Hum Mol Genet* 2008;17:1517-1526.
- (15) Tudor EL, Galtrey CM, Perkinton MS et al. Amyotrophic lateral sclerosis mutant vesicle-associated membrane protein-associated protein-B transgenic mice develop TAR-DNA-binding protein-43 pathology. *Neuroscience* 2010;167:774-785.
- (16) Conforti FL, Sprovieri T, Mazzei R et al. Sporadic ALS is not associated with VAPB gene mutations in Southern Italy. *J Negat Results Biomed* 2006;5:7.

## SUPPLEMENT

## Supplementary Tables

**Supplementary Table 10.1** Baseline characteristics of study population

| Group | Number (n) | Male/female (n) (%) | Age at onset (y) (CI) | Spinal/bulbar (n) (%) | Alive/deceased (n) (%) | Duration (y) (CI) |
|-------|------------|---------------------|-----------------------|-----------------------|------------------------|-------------------|
| SALS  | 755        | 447/308 (59/41)     | 60.2 (59.4-61.1)      | 502/237 (68/32)*      | 114/635 (15/85)**      | 3.8 (3.6-4.1)     |
| FALS  | 111        | 58/53 (52/48)       | 59.0 (56.8-61.2)      | 89/22 (80/20)*        | 30/81 (27/73)**        | 3.9 (3.3-4.5)     |
| Total | 866        | 505/361 (58/42)     | 60.1 (59.3-60.9)      | 591/259 (70/30)       | 148/712 (17/83)        | 3.8 (3.6-4.1)     |

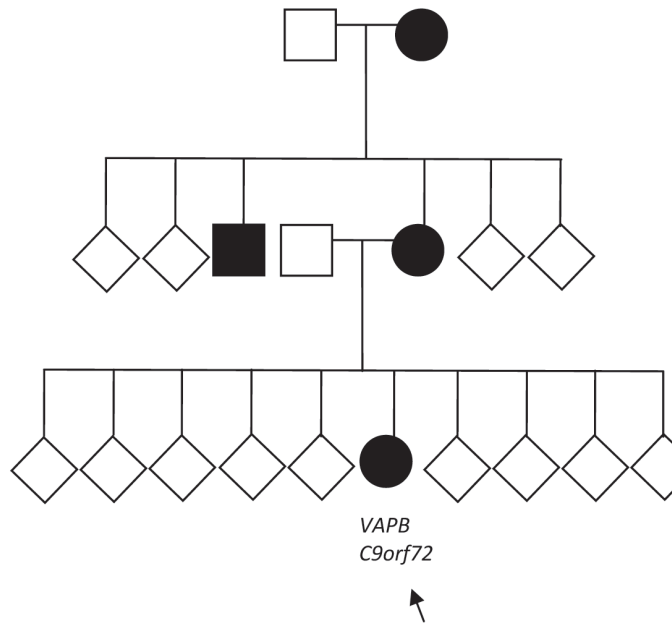
Abbreviations: FALS = familial amyotrophic lateral sclerosis, SALS = sporadic lateral sclerosis, n = number, y = years, and CI = 95% confidence interval. Disease duration is defined as the interval between age at onset and age at death, or between age at onset and age last known to be alive. Fisher's exact test or Chi-square test were used to compare gender, site of onset, and current status (alive/deceased), a Mann-Whitney test was used to compare age at onset and disease duration (GraphPad Prism version 5, <http://www.graphpad.com>). P-values below 0.05 were considered significant. \* P-value 0.003. \*\* P-value 0.004.

**Supplementary Table 10.2** Clinical characteristics of patients with *VAPB* variants

| Variant              | Group   | Gender     | Age at onset (y) | Site of onset | Survival (m) <sup>c</sup> |
|----------------------|---------|------------|------------------|---------------|---------------------------|
| p.D130E              | SALS    | M          | 67               | Cervical      | 28                        |
| p.S158N              | FALS    | F          | 50               | Bulbar        | 12                        |
| p.S160del            | FALS    | M          | 29               | Lumbosacral   | 33                        |
| p.S160del            | SALS    | F          | 54               | Cervical      | 40                        |
| p.S160del            | SALS    | F          | 52               | Cervical      | 104                       |
| p.S160del            | SALS    | M          | 80               | Lumbosacral   | 28                        |
| p.S160del            | SALS    | F          | 56               | Bulbar        | 20                        |
| p.S160del            | SALS    | M          | 76               | Cervical      | 53                        |
| p.M170I              | SALS    | M          | 55               | Lumbosacral   | 32                        |
| p.M170I              | SALS    | M          | 58               | Lumbosacral   | 24                        |
| p.M170I              | SALS    | M          | 41               | Cervical      | 32                        |
| p.M170I              | SALS    | M          | 69               | Lumbosacral   | 17                        |
| p.M170I              | SALS    | M          | 70               | Bulbar        | 14                        |
| p.V234I <sup>a</sup> | FALS    | F          | 65               | Lumbosacral   | 34                        |
|                      | Average | 36% female | 59 y             | 21% bulbar    | 2.8 y                     |

Abbreviations: M = male, F = female, and m = months. <sup>a</sup> This patient also has a *C9orf72* repeat expansion. <sup>b</sup> All patients are deceased.





10

**Supplementary Figure 10.2** Pedigree of FALS patient with *VAPB* mutation and *C9orf72* repeat expansion. The mother of this patient died of ALS at 61 years of age. Furthermore, an uncle and grandmother also died of ALS. DNA of other family members was not available for testing.





# **PART II**

**Genetic studies;  
other neurodegenerative diseases**



# 11

**“Verbindingen zijn gehelen en geen gehelen,  
overeenkomst is onderscheid, samenklank  
wanklank, uit alles één en uit één alles.”**

Herakleitos, Alles Stroomt.



# Genetic overlap between apparently sporadic motor neuron diseases

Marka van Blitterswijk, Lotte Vlam, Michael A. van Es, W.-Ludo van der Pol, Eric A.M. Hennekam, Dennis Dooijes, Helenius J. Schelhaas, Anneke J. van der Kooij, Marianne de Visser, Jan H. Veldink\*, Leonard H. van den Berg\*

\* Contributed equally to this work.

Submitted for publication.

## Abstract

**Objective:** To compare mutation frequencies in genes known to be associated with motor neuron disease (MND) between patients with apparently sporadic progressive muscular atrophy (PMA) and amyotrophic lateral sclerosis (ALS).

**Design:** Sanger sequencing of coding regions of superoxide dismutase-1 (*SOD1*), angiogenin (*ANG*), fused in sarcoma / translated in liposarcoma (*FUS/TLS*), TAR DNA-binding protein (*TARDBP*), and multivesicular body protein 2B (*CHMP2B*).

**Setting:** Three national referral centers for neuromuscular diseases in The Netherlands.

**Patients:** 261 patients with adult-onset sporadic PMA were compared to patients with sporadic ALS and control subjects of Dutch descent.

**Main outcome measure:** Mutation frequencies.

**Results:** In our cohort of PMA patients we identified two *SOD1* mutations (p.D90A, p.I113T), one *ANG* mutation (p.K17I), one *FUS/TLS* mutation (p.R521H), one *TARDBP* mutation (p.N352S), and one novel *CHMP2B* mutation (p.R69Q). The mutation frequency of these genes was similar in sporadic PMA (2.7%) and ALS (2.0%) patients.

**Conclusions:** Our findings demonstrate a genetic overlap between apparently sporadic PMA and ALS.

## Introduction

Motor neuron diseases (MNDs) are a heterogeneous group of disorders characterized by muscle weakness and/or spasticity due to degeneration of motor neurons. Progressive muscular atrophy (PMA) refers to a subgroup of the MND patients with rapidly or gradually developing muscle weakness. PMA accounts for 5-10% of adult-onset MNDs, and is caused by a progressive loss of lower motor neurons (LMNs).<sup>1-3</sup> Differentiation of PMA from ALS is important, since the median survival of patients with PMA is significantly longer than that of patients with ALS.<sup>4,5</sup> Whether PMA is a distinct disease entity or should be considered a subtype of ALS is, however, a matter of debate. Firstly, more than twenty percent of the patients with isolated LMN signs will develop upper motor neuron (UMN) signs within six years, especially in the first years after symptom onset.<sup>5-7</sup> Secondly, pathological studies of PMA patients have shown ubiquitinated inclusions and involvement of the corticospinal tract, which can also be observed in ALS patients.<sup>8,9</sup> Thirdly, familial ALS patients have been reported with mutations in MND-associated genes without UMN signs.<sup>8,10-15</sup>

The etiology of MNDs is complex. Most of the ALS cases, for instance, are sporadic in nature and thought to be caused by an interaction of genetic and environmental factors. Less than two percent of the ALS cases is associated with mutations in superoxide dismutase-1 (*SOD1*), angiogenin (*ANG*), fused in sarcoma / translated in liposarcoma (*FUS/TLS*) or TAR DNA-binding protein (*TARDBP/TDP-43*).<sup>Chapter 9 of this thesis</sup> The combined mutation frequency of these genes is unknown for sporadic PMA patients. Mutations in charged multivesicular body protein 2B (*CHMP2B*) have, however, been reported in sporadic PMA patients.<sup>16,17</sup> Moreover, we have recently shown that chromosome 9 open reading frame 72 (*C9orf72*) repeat expansions can also be detected in apparently sporadic PMA patients.<sup>Chapter 8 of this thesis</sup>

The objective of this study is to determine the mutation frequency of MND-associated genes in patients with sporadic PMA, and to compare their mutation frequencies to those in a large cohort of patients with sporadic ALS.

## Methods

### Cases

We included 261 patients with apparently sporadic PMA and screened their DNA for mutations in *SOD1*, *ANG*, *FUS/TLS*, *TARDBP*, and *CHMP2B*. PMA patients had already

been screened for repeat expansions in *C9orf72*.<sup>Chapter 8 of this thesis</sup> Their diagnosis was based on clinical and electrophysiological examination at time of referral, using criteria described previously.<sup>2</sup> We excluded patients with a family history of PMA, a history of acute poliomyelitis, spinal radiculopathy, diabetic amyotrophy, thyrotoxicosis, or hyperparathyroidism, clinical signs of UMN involvement, sensory signs on neurological examination, structural lesions on magnetic resonance imaging or computed tomography of head and spine, and motor conduction block on extensive standardized nerve conduction studies.<sup>18</sup>

Cohorts of sporadic ALS patients had already been screened for mutations in *SOD1* (n = 451), *ANG* (n = 941), *FUS/TLS* (n = 1,192), *TARDBP* (n = 1,192), vesicle-associated membrane protein B (*VAPB*, n = 755), optineurin (*OPTN*, n = 1,191), valosin-containing protein (*VCP*, n = 754), and *C9orf72* (n = 1,422).<sup>11;19-22; Chapters 8 and 9 of this thesis</sup> We screened 1,002 sporadic ALS patients for mutations in *CHMP2B*. All ALS patients were diagnosed according to the El Escorial Criteria at national referral centers for neuromuscular diseases (University Medical Center Utrecht, Academic Medical Center Amsterdam, or Radboud University Nijmegen Medical Center).<sup>23;24</sup>

Mutations in *SOD1* (n = 1,894), *ANG* (n = 1,582), *FUS/TLS* (n = 970), and *TARDBP* (n = 1,415) had previously been reported in Dutch control subjects.<sup>11;20; Chapter 9 of this thesis</sup> We screened a total of 750 control subjects of Dutch descent for mutations in *CHMP2B*. All material was obtained with approval of the Institutional Review Board, and all participants gave informed consent.

### Genetic analysis

Coding regions of *SOD1*, *ANG*, *FUS/TLS* (exon five, six, fourteen, and fifteen), *TARDBP* (exon six), and *CHMP2B* were screened for mutations using touchdown PCR, as described previously.<sup>11;19;25-27</sup> Sanger sequencing and data analysis were performed with BigDye Terminator 3.1 sequencing kit (Applied Biosystems, Foster City, California), DNA Analyzer 3730XL and PolyPhred.<sup>28</sup> Each mutation was confirmed on genomic DNA and its impact on the structure, and function of the protein was predicted with PolyPhen-2 (<http://genetics.bwh.harvard.edu/pph2/>) and PMut (<http://mmb.pcb.ub.es/PMut/PMut.jsp>).

### Genealogical analysis

Lists of descendants were compiled for index patients. Based on these lists, civil records/ registers, and church records of the Dutch population, pedigrees were generated (containing two parents, four grandparents, eight great-grandparents, etc.). This

information was then used to determine whether index patients were related, and detailed family trees were constructed.

### Haplotype analysis

Extended haplotype analysis, using six extragenic polymorphic markers flanking *TARDBP* (D1S1612, D1S503, D1S244 proximal of *TARDBP*, and D1S2667, D1S2740 and D1S1597 distal of *TARDBP*), was performed to construct a haplotype segregating with the identified p.N352S mutation in *TARDBP*. Validity of the constructed haplotype was determined by segregation analysis in families and patients whose DNA was available for testing.

### Statistical analysis

A Fisher's exact test or Chi-square test was used to compare mutation frequencies, gender, site of onset, and current status (alive/deceased) between PMA and ALS patients; a Mann-Whitney test was used to compare age at onset and disease duration (GraphPad Prism version 5, <http://www.graphpad.com>). P-values below 0.05 were considered significant.

11

## Results and clinical analysis

### Study population

Baseline characteristics of the 261 sporadic PMA patients and 1,002 sporadic ALS patients are shown in Table 11.1. Patients with PMA were more likely to be male (72% versus 59%); furthermore, they lived longer (7.6 year versus 3.8 year), and had a lower age at onset (58.0 year versus 60.6 year) than patients with ALS.

**Table 11.1** Baseline characteristics of study population

| Cohort | Number (n) | Male/female (n) (%) | Age at onset (y) (CI) | Alive/deceased (n) (%) | Duration (y) (CI) |
|--------|------------|---------------------|-----------------------|------------------------|-------------------|
| PMA    | 261        | 187/74 (72/28)      | 58.0 (56.4-59.7)      | 137/116 (54/46)        | 7.6 (6.7-8.5)     |
| ALS    | 1,002      | 593/409 (59/41)     | 60.6 (59.8-61.3)      | 135/854 (14/86)        | 3.8 (3.6-4.1)     |

Abbreviations: PMA = progressive muscular atrophy, ALS = amyotrophic lateral sclerosis, n = number, y = years, and CI = 95% confidence interval. Disease duration is defined as the interval between age at onset and age at death, or between age at onset and age last known to be alive. Patients with sporadic PMA are more likely to be male (p-value 0.0010), to have a lower age at onset (p-value 0.0100), to be alive (p-value < 0.0001), and to have a longer disease duration than patients with sporadic ALS (p-value < 0.0001).

## Mutation frequencies

Table 11.2 summarizes the mutations found in patients and control subjects. In our cohort of PMA patients we detected heterozygous mutations in *SOD1* (p.D90A, p.I113T), *ANG* (p.K17I), *FUS/TLS* (p.R521H) and *TARDBP* (p.N352S), accounting for 2.3% of the patients. Missense mutations in *SOD1*, *ANG*, *FUS/TLS*, and *TARDBP* were also present in 1.7% of the ALS patients, and 0.4% of the control subjects. Furthermore, we identified four novel *CHMP2B* mutations, one of which was present in a PMA patient (p.R69Q), and three in ALS patients (p.R22Q, p.N54T, p.T83I). All four *CHMP2B* mutations are located in a domain that is important for the formation of multivesicular bodies (MVBs), involved in sorting of cargo proteins to intraluminal vesicles.<sup>29;30</sup> These mutations are located in well conserved areas (Supplementary Figure 11.1) and predicted to be pathological (Table 11.2). They account for 0.38% of the sporadic PMA patients and 0.30% of the sporadic ALS patients. None of these *CHMP2B* mutations was present in our control subjects; however, in one control subject (0.13%) we did detect a mutation (p.S194L) that had previously been reported in a patient with frontotemporal dementia (FTD).<sup>31</sup>

## Clinical characteristics

The average age at onset of PMA patients with missense mutations was 48 years, and five of them were male (71%). Although one of these patients had died, their average disease duration already exceeded 114 months (range 37 - 316). These clinical characteristics of sporadic PMA patients with missense mutations were consistent with the characteristics of our entire PMA cohort. More detailed signs and symptoms are provided in Table 11.3.

## Genealogical- and haplotype analyses

Previously, we have shown that the p.N352S mutation in *TARDBP* is a founder mutation in the Dutch ALS population.<sup>Chapter 9 of this thesis</sup> Hence, we performed a thorough genealogical analysis and demonstrated that our PMA patients with p.N352S mutations had common ancestors, dating back to the 17<sup>th</sup> century in the north of France (Supplementary Figure 11.2). Haplotype analysis revealed that these patients also shared the haplotype that was previously reported in Dutch ALS patients.<sup>Chapter 9 of this thesis</sup>

**Table 11.2** Missense mutations found in *SOD1*, *ANG*, *FUS/ITLS*, *TARDBP*, and *CHMP2B*

| Gene             | Variant          | Exon                | PMA                   | ALS                   | CON                   | Prediction PolyPhen-2 | Prediction PMut |
|------------------|------------------|---------------------|-----------------------|-----------------------|-----------------------|-----------------------|-----------------|
| <i>SOD1</i>      | p.D90A           | 4                   | 1/261                 | 1/451 <sup>19</sup>   | 3/1,894 <sup>b</sup>  | Benign                | Pathological    |
|                  | p.I113T          | 4                   | 1/261                 | 0/451                 | 0/1,894               | Probably damaging     | Pathological    |
|                  | p.I99V           | 4                   | 0/261                 | 1/451                 | 0/1,894               | Benign                | Neutral         |
|                  | <b>Total (%)</b> |                     | <b>2/261 (0.77)</b>   | <b>2/451 (0.44)</b>   | <b>3/1,894 (0.16)</b> |                       |                 |
| <i>ANG</i>       | p.G(-10)D        | 2                   | 0/261                 | 1/941                 | 0/1,582 <sup>20</sup> | N/A                   | N/A             |
|                  | p.K17I           | 2                   | 1/261                 | 3/941                 | 2/1,582               | Benign                | Pathological    |
|                  | p.T80S           | 2                   | 0/261                 | 1/941                 | 0/1,582               | Possibly damaging     | Neutral         |
|                  | p.F100I          | 2                   | 0/261                 | 1/941                 | 0/1,582               | Probably damaging     | Neutral         |
| <b>Total (%)</b> |                  | <b>1/261 (0.38)</b> | <b>6/941 (0.64)</b>   | <b>2/1,582 (0.13)</b> |                       |                       |                 |
| <i>FUS/ITLS</i>  | p.S115N          | 5                   | 0/261                 | 1/1,192 <sup>b</sup>  | 0/970 <sup>11</sup>   | Unknown               | Neutral         |
|                  | p.Q210H          | 6                   | 0/261                 | 0/1,192               | 1/970                 | Unknown               | Neutral         |
|                  | p.R487C          | 14                  | 0/261                 | 1/1,192               | 0/970                 | Probably damaging     | Pathological    |
|                  | p.R495X          | 14                  | 0/261                 | 1/1,192               | 0/970                 | N/A                   | N/A             |
|                  | p.R521H          | 15                  | 1/261                 | 0/1,192               | 0/970                 | Probably damaging     | Pathological    |
| <b>Total (%)</b> |                  | <b>1/261 (0.38)</b> | <b>3/1,192 (0.17)</b> | <b>1/970 (0.10)</b>   |                       |                       |                 |
| <i>TARDBP</i>    | p.N352S          | 6                   | 2/261                 | 3/1,192 <sup>b</sup>  | 0/1,415 <sup>b</sup>  | Benign                | Pathological    |
|                  | p.I383V          | 6                   | 0/261                 | 1/1,192               | 0/1,415               | Benign                | Neutral         |
| <b>Total (%)</b> |                  | <b>2/261 (0.77)</b> | <b>4/1,192 (0.34)</b> | <b>0/1,415 (0.00)</b> |                       |                       |                 |
| <i>CHMP2B</i>    | p.R22Q           | 2                   | 0/261 <sup>a</sup>    | 1/1,002 <sup>a</sup>  | 0/750 <sup>a</sup>    | Possibly damaging     | Pathological    |
|                  | p.N54T           | 3                   | 0/261                 | 1/1,002               | 0/750                 | Probably damaging     | Neutral         |
|                  | p.R69Q           | 3                   | 1/261                 | 0/1,002               | 0/750                 | Probably damaging     | Pathological    |
|                  | p.T83I           | 3                   | 0/261                 | 1/1,002               | 0/750                 | Probably damaging     | Pathological    |
|                  | p.S194L          | 6                   | 0/261                 | 0/1,002               | 1/750                 | Benign                | Neutral         |
| <b>Total (%)</b> |                  | <b>1/261 (0.38)</b> | <b>3/1,002 (0.30)</b> | <b>1/750 (0.13)</b>   |                       |                       |                 |
| <b>Total (%)</b> |                  | <b>7 (2.7)</b>      | <b>18 (2.0)</b>       | <b>7 (0.5)</b>        |                       |                       |                 |

Abbreviations: CON = control subjects, and N/A = not applicable. Mutations in *SOD1*, *ANG*, *FUS/ITLS*, *TARDBP*, and *CHMP2B* were present in 2.7% of the PMA patients, 2.0% of the SALS patients, and 0.5% of the control subjects. A Fisher's exact test or Chi-square test was used to compare mutation frequencies between patients with PMA and SALS for each gene; no significant differences were detected (data not shown for simplicity). Cohort described in: <sup>a</sup> This study, or <sup>b</sup> Chapter 9 of this thesis.

**Table 11.3** Clinical characteristics of newly identified patients with missense mutations

| Group | Gene           | Variant | Gender | LMN <sup>a</sup><br>signs | UMN <sup>a</sup><br>signs | Age at<br>onset (y) | Site of onset | Duration<br>(m)  |
|-------|----------------|---------|--------|---------------------------|---------------------------|---------------------|---------------|------------------|
| PMA   | <i>SOD1</i>    | p.D90A  | M      | 1                         | 0                         | 17                  | Cervical      | 316              |
|       |                | p.I113T | F      | 2                         | 0                         | 48                  | Lumbosacral   | 108              |
|       | <i>ANG</i>     | p.K17I  | M      | 1                         | 0                         | 66                  | Lumbosacral   | 52               |
|       | <i>FUS/TLS</i> | p.R521H | M      | 3                         | 0                         | 47                  | Cervical      | 68               |
|       | <i>TARDBP</i>  | p.N352S | F      | 2                         | 0                         | 68                  | Cervical      | 37               |
|       |                | p.N352S | M      | 4                         | 0                         | 61                  | Lumbosacral   | 101 <sup>b</sup> |
|       | <i>CHMP2B</i>  | p.R69Q  | M      | 1                         | 0                         | 26                  | Cervical      | 116              |
| ALS   | <i>CHMP2B</i>  | p.R22Q  | M      | 3                         | 2                         | 57                  | Cervical      | 68               |
|       |                | p.N54T  | F      | 3                         | 2                         | 68                  | Bulbar        | 28 <sup>b</sup>  |
|       |                | p.T83I  | M      | 2                         | 1                         | 71                  | Cervical      | 75               |

Abbreviations: M = male, F = female, LMN = lower motor neuron, UMN = upper motor neuron, and m = months. Clinical characteristics of ALS patients with *SOD1*, *ANG*, *FUS/TLS* and *TARDBP* mutations have been described elsewhere.<sup>11;19;20;Chapter 9 of this thesis</sup> <sup>a</sup> Number of affected body regions at time of diagnosis (maximum four: bulbar, cervical, thoracic or lumbosacral). <sup>b</sup> Deceased.

## Discussion

Patients with isolated LMN signs represent a subgroup of the patients with MND.<sup>1-3</sup> To assess the mutation frequency of MND-associated genes in this subgroup, we compared 261 apparently sporadic PMA patients to apparently sporadic ALS patients. Our PMA patients were more likely to be male and lived significantly longer than ALS patients, as reported previously.<sup>5</sup> We detected two *SOD1* mutations (p.D90A, p.I113T), one *ANG* mutation (p.K17I), one *FUS/TLS* mutation (p.R521H), one *TARDBP* mutation (p.N352S), and one novel *CHMP2B* mutation (p.R69Q) in individual PMA patients. For each of these genes we compared mutation frequencies between our PMA patients and ALS patients, and did not detect significant differences. Clinical and pathological similarities between PMA and ALS have already been reported.<sup>5-9;32;33</sup> Furthermore, in familial ALS patients without UMN signs, mutations in MND-associated genes have been described.<sup>8;10-15</sup> In addition, we have recently shown that *C9orf72* repeat expansions are also present in sporadic PMA patients (1.6%).<sup>Chapter 8 of this thesis</sup> Hence, we have demonstrated that apart from clinical and pathological similarities, sporadic PMA and ALS demonstrate a genetic overlap, suggesting that PMA is a subtype of ALS.

Mutations in *SOD1*, *ANG*, *FUS/TLS*, *TARDBP* and *CHMP2B* have been identified in patients with a range of clinical phenotypes, including FTD (*FUS/TLS*, *TARDBP*, *CHMP2B*),<sup>27;34-36</sup> ALS-FTD (*ANG*, *FUS/TLS*, *TARDBP*, *CHMP2B*),<sup>16;25;37-42</sup> Parkinson's disease (*ANG*,



*TARDBP*),<sup>20,43</sup> FTD and parkinsonism (*TARDBP*),<sup>43</sup> ALS and parkinsonism with dementia (*FUS/TLS*),<sup>42</sup> ALS-FTD with chorea (*SOD1*),<sup>44</sup> ALS with parkinsonian features, motor- and vocal tics and FTD (*TARDBP*),<sup>45</sup> FTD-supranuclear palsy with chorea (*TARDBP*),<sup>46</sup> progressive anarthria (*TARDBP*),<sup>47</sup> and a progressive sensory disorder, followed by a motor disorder (*TARDBP*).<sup>48</sup> *CHMP2B* mutations have also been described in sporadic PMA patients, while *SOD1* and *FUS/TLS* mutations have been detected in familial ALS patients with predominantly LMN signs.<sup>11,12,17</sup> Our findings demonstrate that mutations in *SOD1*, *ANG*, *FUS/TLS*, *TARDBP* and *CHMP2B* are also associated with apparently sporadic PMA and ALS, thus expanding the wide range of clinical phenotypes.

We detected a *SOD1* mutation (p.D90A) in a patient with sporadic PMA, a patient with classical sporadic ALS, and a control subject. This is the most common *SOD1* mutation, and causes both autosomal dominant and recessive ALS.<sup>49,50</sup> Although it behaves dominantly in many families, it is a polymorphism in the Swedish population, primarily causing ALS when in the homozygous state.<sup>51</sup> Another *SOD1* mutation (p.I113T) was also present in a PMA patient; it is known for its clinical heterogeneity, including asymptomatic subjects, patients with mild fasciculations, patients with typical ALS, and patients with ALS-FTD and chorea.<sup>44,52</sup>

In addition, we identified an *ANG* mutation (p.K17I) in one PMA patient, and in two out of 1,582 Dutch control subjects. The p.K17I mutation has already been reported in ALS patients and in control subjects.<sup>20</sup> Despite its presence in control subjects, it does affect the neuroprotective-, angiogenic- and ribonucleolytic activity of *ANG*.<sup>15,53</sup> It seems likely that this mutation raises ALS susceptibility and/or acts as a genetic modifier, a hypothesis supported by recent reports of families that harbor a p.K17I mutation in combination with *TARDBP*- or *FUS/TLS* mutations.<sup>54; Chapter 9 of this thesis</sup>

In one PMA patient, we identified a *FUS/TLS* mutation (p.R521H); one of the most common *FUS/TLS* mutations with a disease duration of approximately four years.<sup>55,56</sup> In two other PMA patients, we detected a *TARDBP* mutation (p.N352S) which has been described in German and Japanese ALS patients.<sup>57-59</sup> We have recently reported that p.N352S is a founder mutation in the Dutch ALS population.<sup>Chapter 9 of this thesis</sup> In the present study, we revealed that our PMA patients had common ancestors and shared a haplotype also detected in Dutch ALS patients.

The four *CHMP2B* mutations we detected (p.R69Q, p.R22Q, p.N54T, p.T83I) are novel, absent in control subjects, located in well conserved areas, and predicted to be pathogenic. One of these was identified in a patient with sporadic PMA (0.38%), three in patients with sporadic ALS (0.30%). These mutation frequencies demonstrate that

*CHMP2B* mutations are not specific for PMA, but are present in patients with PMA, FTD, ALS-FTD, and ALS. We also detected one previously reported mutation (p.S194L) in a control subject.<sup>34</sup> Since this variant is located within an area of low complexity and predicted to have neutral effects, it probably represents a rare but benign polymorphism.

To summarize, we have detected comparable mutation frequencies in patients with apparently sporadic PMA and ALS, indicating a genetic overlap between these two diseases. Thus, our findings favor the hypothesis that PMA is a subtype of ALS and not a distinct entity,<sup>3,5</sup> thus broadening the disease spectrum of ALS.

## References

- (1) Rowland LP. Progressive muscular atrophy and other lower motor neuron syndromes of adults. *Muscle Nerve* 2010;41:161-165.
- (2) Van Den Berg-Vos RM, Visser J, Franssen H et al. Sporadic lower motor neuron disease with adult onset: classification of subtypes. *Brain* 2003;126:1036-1047.
- (3) Van Den Berg-Vos RM, van den Berg LH, Visser J, de Visser M, Franssen H, Wokke JH. The spectrum of lower motor neuron syndromes. *J Neurol* 2003;250:1279-1292.
- (4) Rowland LP, Shneider NA. Amyotrophic lateral sclerosis. *N Engl J Med* 2001;344:1688-1700.
- (5) Kim WK, Liu X, Sandner J et al. Study of 962 patients indicates progressive muscular atrophy is a form of ALS. *Neurology* 2009;73:1686-1692.
- (6) Visser J, Van Den Berg-Vos RM, Franssen H et al. Disease course and prognostic factors of progressive muscular atrophy. *Arch Neurol* 2007;64:522-528.
- (7) Traynor BJ, Codd MB, Corr B, Forde C, Frost E, Hardiman OM. Clinical features of amyotrophic lateral sclerosis according to the El Escorial and Airlie House diagnostic criteria: A population-based study. *Arch Neurol* 2000;57:1171-1176.
- (8) Cudkovicz ME, McKenna-Yasek D, Chen C, Hedley-Whyte ET, Brown RH, Jr. Limited corticospinal tract involvement in amyotrophic lateral sclerosis subjects with the A4V mutation in the copper/zinc superoxide dismutase gene. *Ann Neurol* 1998;43:703-710.
- (9) Ince PG, Evans J, Knopp M et al. Corticospinal tract degeneration in the progressive muscular atrophy variant of ALS. *Neurology* 2003;60:1252-1258.
- (10) Suzuki M, Irie T, Watanabe T et al. Familial amyotrophic lateral sclerosis with Gly93Ser mutation in Cu/Zn superoxide dismutase: a clinical and neuropathological study. *J Neurol Sci* 2008;268:140-144.
- (11) Groen EJ, van Es MA, van Vught PW et al. FUS mutations in familial amyotrophic lateral sclerosis in the Netherlands. *Arch Neurol* 2010;67:224-230.

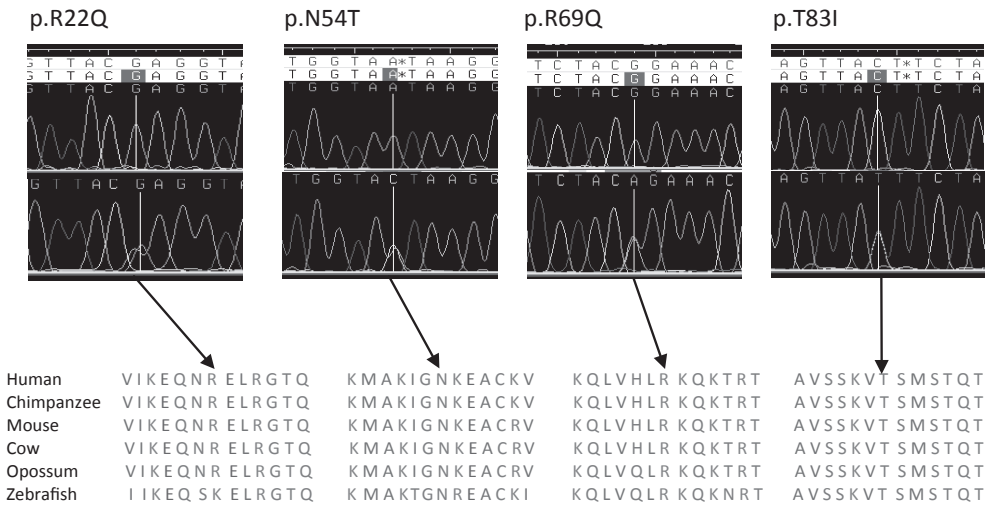
- (12) Cervenakova L, Protas I, Hirano A et al. Progressive muscular atrophy variant of familial amyotrophic lateral sclerosis (PMA/ALS). *J Neurol Sci* 2000;177:124-130.
- (13) Restagno G, Lombardo F, Sbaiz L et al. The rare G93D mutation causes a slowly progressing lower motor neuron disease. *Amyotroph Lateral Scler* 2008;9:35-39.
- (14) Gellera C, Colombrita C, Ticozzi N et al. Identification of new ANG gene mutations in a large cohort of Italian patients with amyotrophic lateral sclerosis. *Neurogenetics* 2008;9:33-40.
- (15) Wu D, Yu W, Kishikawa H et al. Angiogenin loss-of-function mutations in amyotrophic lateral sclerosis. *Ann Neurol* 2007;62:609-617.
- (16) Parkinson N, Ince PG, Smith MO et al. ALS phenotypes with mutations in CHMP2B (charged multivesicular body protein 2B). *Neurology* 2006;67:1074-1077.
- (17) Cox LE, Ferraiuolo L, Goodall EF et al. Mutations in CHMP2B in lower motor neuron predominant amyotrophic lateral sclerosis (ALS). *PLoS One* 2010;5:e9872.
- (18) Van den Berg-Vos RM, Visser J, Kalmijn S et al. A long-term prospective study of the natural course of sporadic adult-onset lower motor neuron syndromes. *Arch Neurol* 2009;66:751-757.
- (19) van Es MA, Dahlberg C, Birve A, Veldink JH, van den Berg LH, Andersen PM. Large-scale SOD1 mutation screening provides evidence for genetic heterogeneity in amyotrophic lateral sclerosis. *J Neurol Neurosurg Psychiatry* 2010;81:562-566.
- (20) van Es MA, Schelhaas HJ, van Vught PW et al. Angiogenin variants in Parkinson disease and amyotrophic lateral sclerosis. *Ann Neurol* 2011;70:964-973.
- (21) van Blitterswijk M, van Vught PW, van Es MA et al. Novel optineurin mutations in sporadic amyotrophic lateral sclerosis patients. *Neurobiol Aging* 2011 Jul 27.
- (22) Koppers M, van Blitterswijk M, Vlam L et al. VCP mutations in familial and sporadic amyotrophic lateral sclerosis. *Neurobiol Aging* 2011 Nov 9.
- (23) Brooks BR, Miller RG, Swash M, Munsat TL. El Escorial revisited: revised criteria for the diagnosis of amyotrophic lateral sclerosis. *Amyotroph Lateral Scler Other Motor Neuron Disord* 2000;1:293-299.
- (24) Brooks BR. El Escorial World Federation of Neurology criteria for the diagnosis of amyotrophic lateral sclerosis. Subcommittee on Motor Neuron Diseases/Amyotrophic Lateral Sclerosis of the World Federation of Neurology Research Group on Neuromuscular Diseases and the El Escorial "Clinical limits of amyotrophic lateral sclerosis" workshop contributors. *J Neurol Sci* 1994;124 Suppl:96-107.
- (25) van Es MA, Diekstra FP, Veldink JH et al. A case of ALS-FTD in a large FALS pedigree with a K17I ANG mutation. *Neurology* 2009;72:287-288.
- (26) Sreedharan J, Blair IP, Tripathi VB et al. TDP-43 mutations in familial and sporadic amyotrophic lateral sclerosis. *Science* 2008;319:1668-1672.
- (27) Skibinski G, Parkinson NJ, Brown JM et al. Mutations in the endosomal ESCRTIII-complex subunit CHMP2B in frontotemporal dementia. *Nat Genet* 2005;37:806-808.

- (28) Nickerson DA, Tobe VO, Taylor SL. PolyPhred: automating the detection and genotyping of single nucleotide substitutions using fluorescence-based resequencing. *Nucleic Acids Res* 1997;25:2745-2751.
- (29) Horii M, Shibata H, Kobayashi R et al. CHMP7, a novel ESCRT-III-related protein, associates with CHMP4b and functions in the endosomal sorting pathway. *Biochem J* 2006;400:23-32.
- (30) Gruenberg J, Stenmark H. The biogenesis of multivesicular endosomes. *Nat Rev Mol Cell Biol* 2004;5:317-323.
- (31) Ghanim M, Guillot-Noel L, Pasquier F et al. CHMP2B mutations are rare in French families with frontotemporal lobar degeneration. *J Neurol* 2010;257:2032-2036.
- (32) Ince PG, Lowe J, Shaw PJ. Amyotrophic lateral sclerosis: current issues in classification, pathogenesis and molecular pathology. *Neuropathol Appl Neurobiol* 1998;24:104-117.
- (33) Geser F, Stein B, Partain M et al. Motor neuron disease clinically limited to the lower motor neuron is a diffuse TDP-43 proteinopathy. *Acta Neuropathol* 2011;121:509-517.
- (34) Borroni B, Archetti S, Del Bo R et al. TARDBP mutations in frontotemporal lobar degeneration: frequency, clinical features, and disease course. *Rejuvenation Res* 2010;13:509-517.
- (35) Borroni B, Bonvicini C, Alberici A et al. Mutation within TARDBP leads to frontotemporal dementia without motor neuron disease. *Hum Mutat* 2009;30:E974-E983.
- (36) Van Langenhove T, van der Zee J, Sleegers K et al. Genetic contribution of FUS to frontotemporal lobar degeneration. *Neurology* 2010;74:366-371.
- (37) Ticozzi N, Silani V, Leclerc AL et al. Analysis of FUS gene mutation in familial amyotrophic lateral sclerosis within an Italian cohort. *Neurology* 2009;73:1180-1185.
- (38) Benajiba L, Le Ber I, Camuzat A et al. TARDBP mutations in motoneuron disease with frontotemporal lobar degeneration. *Ann Neurol* 2009;65:470-473.
- (39) Broustal O, Camuzat A, Guillot-Noel L et al. FUS mutations in frontotemporal lobar degeneration with amyotrophic lateral sclerosis. *J Alzheimers Dis* 2010;22:765-769.
- (40) Mackenzie IR, Rademakers R, Neumann M. TDP-43 and FUS in amyotrophic lateral sclerosis and frontotemporal dementia. *Lancet Neurol* 2010;9:995-1007.
- (41) Blair IP, Williams KL, Warraich ST et al. FUS mutations in amyotrophic lateral sclerosis: clinical, pathological, neurophysiological and genetic analysis. *J Neurol Neurosurg Psychiatry* 2010;81:639-645.
- (42) Yan J, Deng HX, Siddique N et al. Frameshift and novel mutations in FUS in familial amyotrophic lateral sclerosis and ALS/dementia. *Neurology* 2010;75:807-814.
- (43) Quadri M, Cossu G, Saddi V et al. Broadening the phenotype of TARDBP mutations: the TARDBP Ala382Thr mutation and Parkinson's disease in Sardinia. *Neurogenetics* 2011;12:203-209.
- (44) Lopate G, Baloh RH, Al-Lozi MT et al. Familial ALS with extreme phenotypic variability due to the I113T SOD1 mutation. *Amyotroph Lateral Scler* 2010;11:232-236.

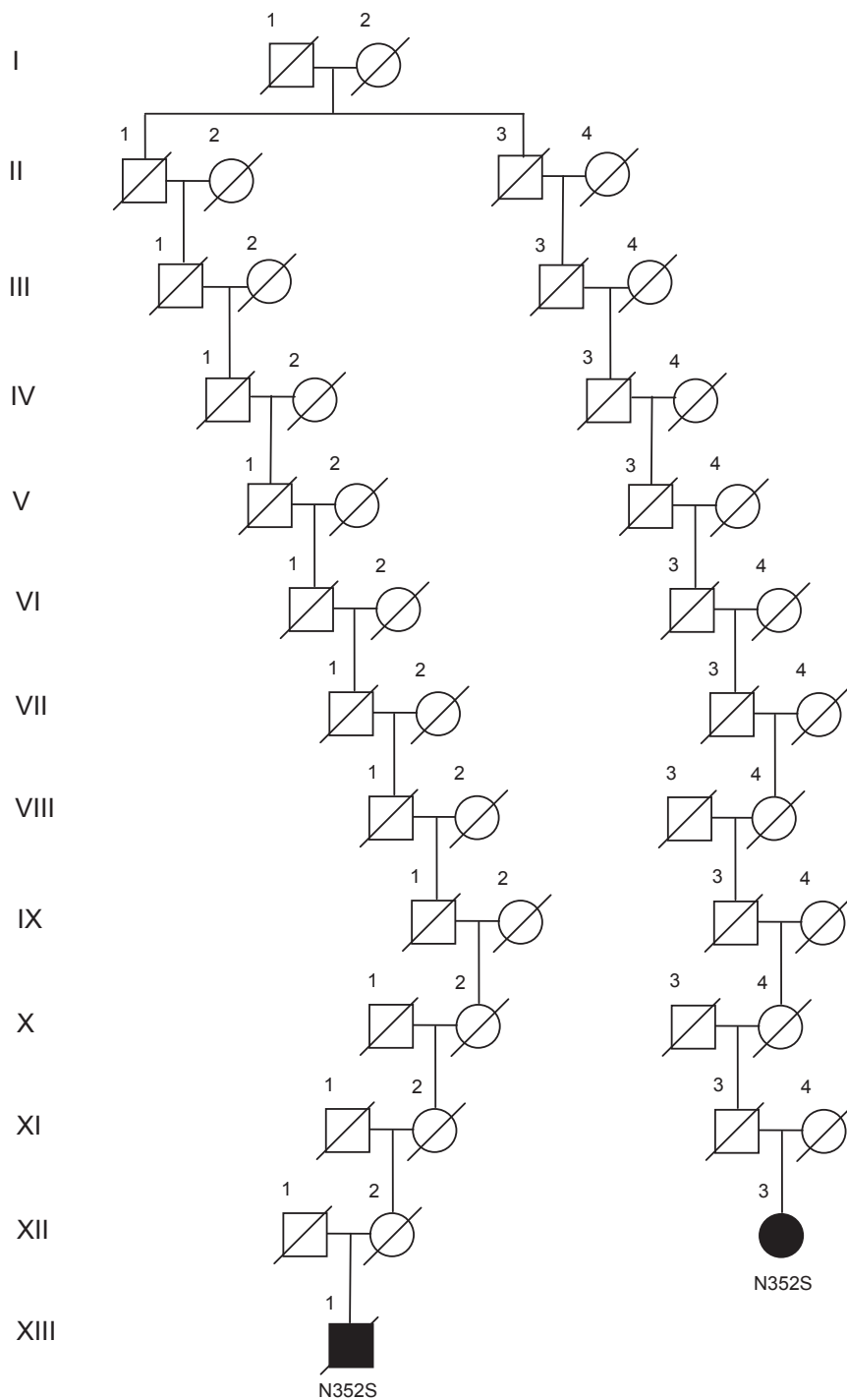
- (45) Borghero G, Floris G, Cannas A et al. A patient carrying a homozygous p.A382T TARDBP missense mutation shows a syndrome including ALS, extrapyramidal symptoms, and FTD. *Neurobiol Aging* 2011;32:2327.e1-e5.
- (46) Kovacs GG, Murrell JR, Horvath S et al. TARDBP variation associated with frontotemporal dementia, supranuclear gaze palsy, and chorea. *Mov Disord* 2009;24:1843-1847.
- (47) Praline J, Vourc'h P, Guennoc AM, Veyrat-Durebex C, Corcia P. Co-occurrence of progressive anarthria with an S393L TARDBP mutation and ALS within a family. *Amyotroph Lateral Scler* 2012;13:155-157.
- (48) Camdessanche JP, Belzil VV, Jousserand G et al. Sensory and motor neuronopathy in a patient with the A382PTDP-43 mutation. *Orphanet J Rare Dis* 2011;6:4.
- (49) Robberecht W, Aguirre T, Van Den Bosch L, Tilkin P, Cassiman JJ, Matthijs G. D90A heterozygosity in the SOD1 gene is associated with familial and apparently sporadic amyotrophic lateral sclerosis. *Neurology* 1996;47:1336-1339.
- (50) Andersen PM, Nilsson P, Ala-Hurula V et al. Amyotrophic lateral sclerosis associated with homozygosity for an Asp90Ala mutation in CuZn-superoxide dismutase. *Nat Genet* 1995;10:61-66.
- (51) Valdmanis PN, Rouleau GA. Genetics of familial amyotrophic lateral sclerosis. *Neurology* 2008;70:144-152.
- (52) Eisen A, Mezei MM, Stewart HG, Fabros M, Gibson G, Andersen PM. SOD1 gene mutations in ALS patients from British Columbia, Canada: clinical features, neurophysiology and ethical issues in management. *Amyotroph Lateral Scler* 2008;9:108-119.
- (53) Sebastia J, Kieran D, Breen B et al. Angiogenin protects motoneurons against hypoxic injury. *Cell Death Differ* 2009;16:1238-1247.
- (54) Millicamps S, Salachas F, Cazeneuve C et al. SOD1, ANG, VAPB, TARDBP, and FUS mutations in familial amyotrophic lateral sclerosis: genotype-phenotype correlations. *J Med Genet* 2010;47:554-560.
- (55) Kwiatkowski TJ, Jr., Bosco DA, Leclerc AL et al. Mutations in the FUS/TLS gene on chromosome 16 cause familial amyotrophic lateral sclerosis. *Science* 2009;323:1205-1208.
- (56) Vance C, Rogelj B, Hortobagyi T et al. Mutations in FUS, an RNA processing protein, cause familial amyotrophic lateral sclerosis type 6. *Science* 2009;323:1208-1211.
- (57) Kuhnlein P, Sperfeld AD, Vanmassenhove B et al. Two German kindreds with familial amyotrophic lateral sclerosis due to TARDBP mutations. *Arch Neurol* 2008;65:1185-1189.
- (58) Kamada M, Maruyama H, Tanaka E et al. Screening for TARDBP mutations in Japanese familial amyotrophic lateral sclerosis. *J Neurol Sci* 2009;284:69-71.
- (59) Iida A, Kamei T, Sano M et al. Large-scale screening of TARDBP mutation in amyotrophic lateral sclerosis in Japanese. *Neurobiol Aging* 2012;33:786-790.

## SUPPLEMENT

### Supplementary Figures



**Supplementary Figure 11.1** *CHMP2B* mutations and conservation. Conservation of amino acid residues across species was generated using ClustalW2 online tool, <http://www.ebi.ac.uk/Tools/msa/clustalw2/>. See Appendix page 385 for Supplementary Figure 11.1 in color.



Supplementary Figure 11.2 Pedigree of two PMA patients with p.N352S mutations in *TARDBP*.

# 12

**“De meest beschamende reden voor gebrek aan kennis is dat zij die wel op de hoogte zijn die kennis niet willen doorgeven, alsof zij zelf zouden kwijtraken wat ze aan anderen overdragen.”**

Plinius, De wereld, Naturalis Historia.



# Mutations in the *TRPV4* gene are not associated with sporadic progressive muscular atrophy

Lotte Vlam, Helenius J. Schelhaas, Marka van Blitterswijk,  
Paul W.J. van Vught, Marianne de Visser, Anneke J. van der Kooi,  
W.-Ludo van der Pol, Leonard H. van den Berg

*Arch Neurol.* In press.

## Introduction

Progressive muscular atrophy (PMA) is an adult-onset neurodegenerative disease characterized by progressive loss of lower motor neurons (LMNs). Its disease course ranges from slowly progressive in many years to rapid progression rates, similar to those observed in patients with amyotrophic lateral sclerosis (ALS).<sup>1</sup> Whether PMA is a distinct disease identity separate from ALS remains questionable, especially since upper motor neuron signs may develop over time<sup>1</sup> and mutations in the superoxide dismutase-1 (*SOD1*) gene, which are a known cause of ALS, have also been identified in patients with familial PMA.<sup>2</sup> Moreover, mutations in the charged multivesicular protein 2B (*CHMP2B*) gene have been reported in three patients with sporadic LMN predominant ALS.<sup>3</sup> Non-synonymous mutations in the transient receptor potential vanilloid 4 (*TRPV4*) gene, which encodes a calcium permeable protein channel, have recently been identified in patients with LMN disorders, such as congenital distal spinal muscular atrophy, scapulo-peroneal spinal muscular atrophy (SPSMA), and Charcot-Marie-Tooth (CMT)/hereditary motor and sensory neuropathy (HMSN) type 2c.<sup>4,5</sup> These disorders are characterized by predominant LMN degeneration. The *TRPV4* gene is of special interest since mutations may lead to neurotoxicity induced by intracellular hypercalcemia, and therefore, pharmacological blockade of *TRPV4* channels may offer a target for therapy of *TRPV4*-associated disorders.<sup>6</sup> We hypothesized that *TRPV4* may be a candidate gene for susceptibility to PMA, and screened a Dutch cohort of patients with sporadic PMA and controls for non-synonymous mutations.

## Methods

A total of 264 patients with sporadic PMA and 768 healthy controls, all Caucasian and from Dutch descent, were included in the study. Patients were seen by experienced neurologists at the Dutch national referral center for ALS. Diagnosis was based on LMN involvement on neurological and electrophysiological examination. Exclusion criteria included a history of acute poliomyelitis, spinal radiculopathy, diabetic amyotrophy, thyrotoxicosis, or hyperparathyroidism, sensory signs on neurological examination, structural lesions on magnetic resonance imaging or computed tomography of head and spine, motor conduction block on extensive standardized nerve conduction studies and clinical signs of upper motor neuron involvement—that is, pseudobulbar symptoms, clonus of the masseter reflex, hyperreflexia (including brisk reflexes in weakened muscles), or extensor plantar response.<sup>1</sup> The Medical Ethical Committee of the University Medical Center Utrecht approved the study protocol and all patients gave informed consent.

Genomic DNA was extracted from peripheral blood using standard methodology. Coding regions of *TRPV4* were screened for mutations by direct sequencing. Primers for PCR amplification were designed using LIMSTILL (<http://limstill.niob.knaw.nl>) and are available on request. The PCR amplification fragments were sequenced with BigDye Terminator 3.1 sequencing kit (Applied Biosystems, Foster City, California), and analyzed on a 3730XL DNA Analyzer. Each identified mutation was confirmed by an independent PCR and sequencing reaction. Impact of the mutation on the structure and function of the protein was predicted with PolyPhen-2 (<http://genetics.bwh.harvard.edu/pph2/>) and PMut (<http://mmb.pcb.ub.es/PMut/PMut.jsp>).

## Results

Patient characteristics and the results of the *TRPV4* gene analysis are shown in Table 12.1. None of the previously described mutations (p.R232C, p.R269H, p.R269C, p.R315T, p.R316C, p.V620I)<sup>4;5</sup> were identified in our patients with PMA. We did, however, identify a novel heterozygous c.2337G>A mutation in exon fourteen, changing valine to isoleucine at position 750 (p.V750I). Nonetheless, the estimated impact of this mutation was neutral or benign, and it was also present in two control subjects.

12

**Table 12.1** Study population characteristics and results of *TRPV4* analysis

|                           | Patients | Controls |
|---------------------------|----------|----------|
| <b>Characteristics</b>    |          |          |
| No. of subjects           | 264      | 768      |
| Age, median, y            | 63       | 62       |
| Gender, male/female, No.  | 189/75   | 426/340  |
| <b>Results</b>            |          |          |
| Mutation p.V750I, No. (%) | 2 (0.8)  | 2 (0.3)  |
| PolyPhen                  | Benign   |          |
| PMut                      | Neutral  |          |
| P-value*                  | 0.27     |          |

Abbreviations: no. = number, and y = years. \* Using Fisher's exact test

## Comment

Recent studies have demonstrated that mutations in the *TRPV4* gene are associated with a heterogeneous group of diseases characterized by LMN or axonal degeneration. We evaluated genetic variance in this gene as possible risk factor for PMA, but none of the previously described mutations could be identified. One novel mutation was detected at similar frequencies in patients and controls ( $p$ -value 0.27), and thus, most likely represents a rare benign polymorphism. Hence, we conclude that genetic heterogeneity of *TRPV4* is not associated with PMA.

## References

- (1) Van den Berg-Vos RM, Visser J, Kalmijn S, et al. A long-term prospective study of the natural course of sporadic adult-onset lower motor neuron syndromes. *Arch Neurol* 2009;66:751-757.
- (2) Rowland LP. Progressive muscular atrophy and other lower motor neuron syndromes of adults. *Muscle Nerve* 2010;41:161-165.
- (3) Cox LE, Ferraiuolo L, Goodall EF, et al. Mutations in CHMP2B in lower motor neuron predominant amyotrophic lateral sclerosis (ALS). *PLoS One* 2010;5:e9872.
- (4) Auer-Grumbach M, Olschewski A, Papic L, et al. Alterations in the ankyrin domain of TRPV4 cause congenital distal SMA, scapuloperoneal SMA and HMSN2C. *Nat Genet* 2010;42:160-164.
- (5) Zimon M, Baets J, Auer-Grumbach M, et al. Dominant mutations in the cation channel gene transient receptor potential vanilloid 4 cause an unusual spectrum of neuropathies. *Brain* 2010;133:1798-1809.
- (6) Baets J, De Jonghe P. TRPV4 neuropathies: Calcium channel inhibition as a therapeutic target? *Neurology* 2011;76:856-857.

# 12

# 13

**“Ik zal niet mijn best doen om de aanwezigen te overtuigen dat wat ik zeg waar is, of het moest terloops gebeuren, maar om zelf zoveel mogelijk te geloven dat het zo is.”**

Plato, Faidon.

# Mutational analysis of *TARDBP* in neurodegenerative diseases

Nicola Ticozzi, Ashley Lyn LeClerc, Marka van Blitterswijk, Pamela Keagle, Diane M. McKenna-Yasek, Peter C. Sapp, Vincenzo Silani, Anne-Marie Wills, Robert H. Brown Jr, John E. Landers

## Abstract

Neurodegenerative diseases are often characterized by the presence of misfolded protein aggregates. TDP-43 is a major component of these aggregates in amyotrophic lateral sclerosis (ALS), but has also been observed in Alzheimer's (AD) and Parkinson's (PD) diseases. In addition, mutations in the TAR DNA-binding protein (*TARDBP*) gene, encoding TDP-43, have been found to be a significant cause of familial ALS (FALS). All mutations, except for one, have been found in exon six. To confirm this observation in ALS, and to investigate whether *TARDBP* may play a role in the pathogenesis of AD and PD, we screened for mutations in exon six of the *TARDBP* gene in three cohorts composed of 376 AD, 463 PD (18% familial PD) and 376 ALS patients (50% FALS). We found mutations in ~7% of FALS and ~0.5% of sporadic ALS (SALS) patients, including two novel mutations, p.N352T and p.G384R. In contrast, we did not find *TARDBP* mutations in our cohort of AD and PD patients. These results suggest that mutations in *TARDBP* are not a significant cause of AD and PD.



## Introduction

Neurodegenerative diseases are often characterized by the presence of intracellular or extracellular protein aggregates in the central nervous system. An evolving molecular classification of these disorders is based upon the biochemical nature of the proteins forming the inclusions. The presence of tau-negative, ubiquitinated inclusions (UBIs) in the perikaryon and proximal axons of surviving motor neurons is the neuropathological hallmark of amyotrophic lateral sclerosis (ALS) and indicates a failure of the proteasome to recycle damaged proteins.<sup>1</sup> UBIs are also observed in cortical neurons of patients with tau-negative and ubiquitin-positive frontotemporal dementia (FTD-U), the most common neuropathological presentation of FTD.<sup>2</sup>

TDP-43 is a protein of 43 kDa (414 residues) encoded by the TAR DNA-binding protein (*TARDBP*) gene that has been identified as the major component of UBIs in brain tissues from ALS and FTD-U patients.<sup>3</sup> Its involvement in both disorders is consistent with the view that these two neurodegenerative conditions share common molecular pathways. TDP-43 belongs to the family of heterogeneous nuclear ribonucleoproteins (hnRNPs) and has been identified as a transcriptional repressor<sup>4</sup> and as promoting exon skipping.<sup>5</sup> Interestingly, mutations in the *TARDBP* gene have been described as major cause of familial ALS (FALS) and have also been identified in sporadic ALS cases (SALS) and FTD with associated motor neuron disease.<sup>6-9</sup> With only one exception, the mutations have been found in exon six.

By contrast with *TARDBP* gene mutations, which have been described only in ALS and FTD-U, TDP-43-positive inclusions have been observed in diverse neurodegenerative disorders, including not only FTD and ALS, but also Alzheimer's disease (AD), alpha-synucleinopathies (such as Parkinson's disease [PD] and dementia with Lewy bodies), and tauopathies (corticobasal degeneration). In autopsy studies, it is estimated that as many as 20% of AD<sup>10</sup> and ~7% of PD<sup>11</sup> cases reveal evidence of TDP-43 immunoreactivity in the central nervous system. These findings raise the hypothesis that primary germline *TARDBP* mutations may be present in neurodegenerative diseases other than ALS and FTD-U. Although no *TARDBP* mutations have been identified so far in those populations,<sup>9;12;13</sup> it is possible that the cohorts studied were underpowered. To investigate this hypothesis, we screened the *TARDBP* gene for exon six mutations in two cohorts of AD and PD patients. To better assess the role of *TARDBP* in the pathogenesis of these disorders, we also screened a set of FALS and SALS patients.

## Materials and methods

### Study population

To determine whether *TARDBP* mutations are present in AD and PD, we obtained two cohorts of 376 AD patients and 463 PD patients, with Institutional Review Board approval. All AD samples were diagnosed with definite AD according to the NINCDS-ADRDA criteria<sup>14</sup> and were obtained from the Massachusetts General Hospital Alzheimer Disease Research Center Tissue Repository. No information is available regarding the family history of the AD cases screened. PD samples were collected at the Coriell Institute for Biomedical Research Cell Repositories (panels NDPT005, NDPT015 and NDPT016) and at the Massachusetts General Hospital Institute for Neurodegenerative Diseases. The PD cohort included 82 patients (18%) with a positive family history for Parkinsonism. All the patients met the UK Brain Bank Criteria for idiopathic PD,<sup>15</sup> and clinical records were reviewed by a neurologist with expertise in movement disorders. Additionally, we screened DNA from 397 ALS patients (208 FALS and 188 SALS) who had been diagnosed with ALS, according to the revised El Escorial criteria.<sup>16</sup> All FALS patients tested negative for mutations in the superoxide dismutase-1 (*SOD1*) and fused in sarcoma / translated in liposarcoma (*FUS/TLS*) genes.

### Molecular analysis

Mutational screening of exon six of *TARDBP* was performed by touchdown PCR using primers TDP43Ex6F (agtaaaacgacggccagttgaatcagtggttaatcttcttg) and TDP43Ex6R (gcaggaaacagctatgacaaaattgaattcccaccattc). These primers anneal to adjacent intronic and 3'UTR regions of exon six and contain 5' tails encoding M13 forward and reverse. PCR-products were subsequently purified by incubation with Exonuclease I and Shrimp Alkaline Phosphatase, sequenced with M13 primers using the BigDyeTerminator v3.1 Cycle Sequencing Kit (Applied Biosystems, Foster City, CA, USA) and then resolved by capillary electrophoresis on an ABI 3730XL DNA Analyzer (Applied Biosystem). Sequence analysis was performed using the PHRED/PHRAP/Consed software suite (<http://www.phrap.org/>) and variations in the sequences were identified with the Polyphred v6.15 software (<http://droog.gs.washington.edu/polyphred/>).

## Results

In our ALS cohort, the screening of exon six of the *TARDBP* gene revealed ten different heterozygous missense mutations in fourteen patients (Table 13.1 and Supplementary

**Table 13.1** *TARDBP* mutations within familial and sporadic ALS

| Nucleotide change | Amino acid mutation | FALS |     | SALS |     |
|-------------------|---------------------|------|-----|------|-----|
|                   |                     | n    | %   | n    | %   |
| 883G > C          | p.G295R             | 0    | 0   | 1    | 0.5 |
| 943G > A          | p.A315T             | 1    | 0.5 | 0    | 0   |
| 1035C > A         | p.N345K             | 1    | 0.5 | 0    | 0   |
| 1042G > T         | p.G348C             | 2    | 1.0 | 0    | 0   |
| 1055A > G         | p.N352T             | 2    | 1.0 | 0    | 0   |
| 1132A > G         | p.N378D             | 1    | 0.5 | 0    | 0   |
| 1135T > C         | p.S379P             | 1    | 0.5 | 0    | 0   |
| 1147G > A         | p.I383V             | 3    | 1.4 | 0    | 0   |
| 1150G > C         | p.G384R             | 1    | 0.5 | 0    | 0   |
| 1168A > G         | p.N390D             | 1    | 0.5 | 0    | 0   |
| Total             |                     | 13   | 6.3 | 1    | 0.5 |

Abbreviations: FALS = familial amyotrophic lateral sclerosis, SALS = sporadic amyotrophic lateral sclerosis, and n = number.

Table 13.1). Three of the mutations observed were novel (p.N352T, p.N378D and p.G384R), although the substitution of asparagine 352 with a serine has been previously described in a German kindred.<sup>47</sup> In contrast, the screening of both the PD and AD cohorts did not reveal any mutations within the coding region of exon six.

With the exception of p.G295R, which has been identified in a single SALS individual, all other mutations have been found exclusively in FALS cases. Thus, the frequency of *TARDBP* mutations in our cohort is more than ten-times higher in FALS than SALS. Our observation that *TARDBP* mutations account for ~6.3% of all *SOD1* and *FUS/TLS* negative FALS patients is consistent with the results of previous studies.<sup>18</sup> On the contrary, we observed a lower-than-expected *TARDBP* mutational frequency in SALS (~0.5%) in comparison with other screenings that reported mutations in ~2% of sporadic cases.<sup>9,18,19</sup>

Three variants (p.I383V, p.G348C, and p.N352T) account for half of the *TARDBP* mutations identified in our cohort and are present in ~1% of FALS patients respectively. The majority of the thirty *TARDBP* mutations described so far have been identified in isolated kindred or sporadic cases. The most frequently observed mutation, p.A382T, has been reported in nine patients of French and Italian origin.<sup>7,18</sup> We did not detect p.A382T in our cohort, possibly due to a different ethnic background of our patients.

With the exception of p.I383V, all the detected mutations change residues that are conserved throughout evolution. Accordingly, they are predicted to have a deleterious effect on protein structure or function by at least one of the two following *in silico* software applications: SNAP (<http://cubic.bioc.columbia.edu/services/SNAP/>) and PMut (<http://mmb2.pcb.ub.es:8080/PMut/>). Although not fully conserved, we hypothesize that the substitution of isoleucine 383 with valine is pathogenic, since the mutation has been observed in four FALS cases,<sup>13</sup> including ours, but not in 4,252 healthy controls from different populations.<sup>7-9;17;18</sup>

## Discussion

Our mutational screening failed to identify *TARDBP* exon six mutations within a cohort of 376 AD and 463 PD patients. However, within ALS samples we identified seven previously described *TARDBP* mutations and three novel mutations, p.N352T, p.N378D and p.G384R, all affecting residues conserved throughout evolution and predicted to be pathogenic by *in silico* analysis. The *TARDBP* mutations represent ~6.3% of our FALS cohort. Since *SOD1* and *FUS/TLS* mutations are observed in ~25% of ALS pedigrees, we estimate a mutational frequency for *TARDBP* of 4.7%. These findings are consistent with previous reports,<sup>18</sup> and substantiate the observation that *TARDBP* mutations represent the second most frequent cause of FALS after *SOD1*.

In the SALS cohort, we observed a p.G295R mutation in a single patient, for a mutational frequency of ~0.5%. Our observations thus differ from other studies that report *TARDBP* mutations in ~2% of all SALS cases.<sup>9;18;19</sup> The discrepancy may reflect the differing ethnic backgrounds among the patient cohorts studied to date. Alternatively, it may reflect a statistically insignificant variant; because *TARDBP* variants are much less frequent in SALS than FALS, larger cohorts are likely required to correctly assess their mutational frequency in SALS.

Although TDP-43-positive inclusions have been described in neurons of patients affected with AD, PD and other neurodegenerative diseases, *TARDBP* mutations have been observed only in ALS with or without associated FTD. Three previous reports could not find mutations in 46 AD,<sup>13</sup> 125 PD,<sup>12</sup> and 41 patients with neurodegenerative diseases other than ALS or FTD-U.<sup>9</sup> Given the low mutational frequency of *TARDBP* in sporadic cases, we attempted to validate these results in two larger AD and PD cohorts. Given that we also failed to find exon six mutations in our cohort, it seems unlikely that *TARDBP* mutations in exon six are involved in the pathogenesis of AD and PD. Our rationale in screening only exon six of the *TARDBP* gene relies on the observation that almost all the

ALS-associated mutations are clustered in the C-terminal region of the gene. Moreover, in neuronal inclusions, TDP-43 is abnormally cleaved to generate 25 kDa C-terminal fragments,<sup>3</sup> suggesting that the region encoded by exon six is crucial for the formation of aggregates. We cannot, however, exclude that mutations in other regions of the gene may be associated to AD and PD pathogenesis. Also, since the frequency of TDP-43 inclusions in idiopathic PD is ~7%, it is possible that our PD cohort, while considerably larger than those previously studied, is still underpowered to detect *TARDBP* mutations. Further studies are necessary to determine if TDP-43 is an innocent bystander that is co-precipitated in aggregates or, more interestingly, if the protein is actively involved in the pathogenic pathways leading to AD and PD. Supporting the latter hypothesis is the evidence that the presence of a TDP-43 abnormal immunoreactivity is associated with a modified AD phenotype characterized by a greater cognitive impairment and a more pronounced hippocampal atrophy.<sup>20</sup>

## Acknowledgements

A special thanks to the patients and their caregivers. Generous support was provided by the ALSTherapy Alliance, Project ALS, the Angel Fund, the Pierre L. de Bourgknecht ALS Research Foundation, the AI-Athel ALS Research Foundation, the ALS Family Charitable Foundation and the NINDS (NS050557). NT and VS were supported by the Italian Ministry of Health (Malattie Neurodegenerative, ex Art.56, n.533F/N1). PS was supported by the Howard Hughes Medical Institute (HHMI) through the auspices of Prof. H. Robert Horvitz, an Investigator in the HHMI. The MGH PD DNA Bank is supported by the National Parkinson Foundation and the NIH (5P50NS038372-10).

## References

- (1) Leigh PN, Whitwell H, Garofalo O et al. Ubiquitin-immunoreactive intraneuronal inclusions in amyotrophic lateral sclerosis. Morphology, distribution, and specificity. *Brain* 1991;114 ( Pt 2):775-788.
- (2) Forman MS, Farmer J, Johnson JK et al. Frontotemporal dementia: clinicopathological correlations. *Ann Neurol* 2006;59:952-962.
- (3) Neumann M, Sampathu DM, Kwong LK et al. Ubiquitinated TDP-43 in frontotemporal lobar degeneration and amyotrophic lateral sclerosis. *Science* 2006;314:130-133.
- (4) Ou SH, Wu F, Harrich D, Garcia-Martinez LF, Gaynor RB. Cloning and characterization of a novel cellular protein, TDP-43, that binds to human immunodeficiency virus type 1 TAR DNA sequence motifs. *J Virol* 1995;69:3584-3596.
- (5) Buratti E, Dork T, Zuccato E, Pagani F, Romano M, Baralle FE. Nuclear factor TDP-43 and SR proteins promote in vitro and in vivo CFTR exon 9 skipping. *EMBO J* 2001;20:1774-1784.
- (6) Benajiba L, Le Ber I, Camuzat A et al. TARDBP mutations in motoneuron disease with frontotemporal lobar degeneration. *Ann Neurol* 2009;65:470-473.
- (7) Kabashi E, Valdmanis PN, Dion P et al. TARDBP mutations in individuals with sporadic and familial amyotrophic lateral sclerosis. *Nat Genet* 2008;40:572-574.
- (8) Sreedharan J, Blair IP, Tripathi VB et al. TDP-43 mutations in familial and sporadic amyotrophic lateral sclerosis. *Science* 2008;319:1668-1672.
- (9) Van Deerlin VM, Leverenz JB, Bekris LM et al. TARDBP mutations in amyotrophic lateral sclerosis with TDP-43 neuropathology: a genetic and histopathological analysis. *Lancet Neurol* 2008;7:409-416.
- (10) Amador-Ortiz C, Lin WL, Ahmed Z et al. TDP-43 immunoreactivity in hippocampal sclerosis and Alzheimer's disease. *Ann Neurol* 2007;61:435-445.
- (11) Nakashima-Yasuda H, Uryu K, Robinson J et al. Co-morbidity of TDP-43 proteinopathy in Lewy body related diseases. *Acta Neuropathol* 2007;114:221-229.
- (12) Kabashi E, Daoud H, Riviere JB et al. No TARDBP mutations in a French Canadian population of patients with Parkinson disease. *Arch Neurol* 2009;66:281-282.
- (13) Rutherford NJ, Zhang YJ, Baker M et al. Novel mutations in TARDBP (TDP-43) in patients with familial amyotrophic lateral sclerosis. *PLoS Genet* 2008;4:e1000193.
- (14) McKhann G, Drachman D, Folstein M, Katzman R, Price D, Stadlan EM. Clinical diagnosis of Alzheimer's disease: report of the NINCDS-ADRDA Work Group under the auspices of Department of Health and Human Services Task Force on Alzheimer's Disease. *Neurology* 1984;34:939-944.
- (15) Hughes AJ, Daniel SE, Kilford L, Lees AJ. Accuracy of clinical diagnosis of idiopathic Parkinson's disease: a clinico-pathological study of 100 cases. *J Neurol Neurosurg Psychiatry* 1992;55:181-184.
- (16) Miller RG, Munsat TL, Swash M, Brooks BR. Consensus guidelines for the design and implementation of clinical trials in ALS. World Federation of Neurology committee on Research. *J Neurol Sci* 1999;169:2-12.

- (17) Kuhnlein P, Sperfeld AD, Vanmassenhove B et al. Two German kindreds with familial amyotrophic lateral sclerosis due to TARDBP mutations. *Arch Neurol* 2008;65:1185-1189.
- (18) Corrado L, Ratti A, Gellera C et al. High frequency of TARDBP gene mutations in Italian patients with amyotrophic lateral sclerosis. *Hum Mutat* 2009;30:688-694.
- (19) Daoud H, Valdmanis PN, Kabashi E et al. Contribution of TARDBP mutations to sporadic amyotrophic lateral sclerosis. *J Med Genet* 2009;46:112-114.
- (24) Josephs KA, Whitwell JL, Knopman DS et al. Abnormal TDP-43 immunoreactivity in AD modifies clinicopathologic and radiologic phenotype. *Neurology* 2008;70:1850-1857.

## SUPPLEMENT

### Supplementary Table

**Supplementary Table 13.1** Clinical information on patients with *TARDBP* mutations

| Bp change | Mutation | Diagnosis | Diagnosis-ALS             | Gender | Ethnicity        | Age at onset | Site of onset | Survival |
|-----------|----------|-----------|---------------------------|--------|------------------|--------------|---------------|----------|
| 883G>C    | p.G295R  | SALS      | Definite                  | M      | Caucasian        | 37           | LE            | 152      |
| 943G>A    | p.A315T  | FALS      | Suspected                 | M      | Caucasian        | N/A          | N/A           | N/A      |
| 1035C>A   | p.N345K  | FALS      | Probable                  | M      | Caucasian        | 41           | B             | 20       |
| 1042G>T   | p.G348C  | FALS      | Probable<br>lab supported | M      | Caucasian        | 43           | LE            | 67       |
| 1042G>T   | p.G348C  | FALS      | Definite                  | F      | Caucasian        | 53           | N/A           | N/A      |
| 1055A>G   | p.N352T  | FALS      | Definite                  | M      | Caucasian        | 66           | N/A           | 36       |
| 1055A>G   | p.N352T  | FALS      | Possible                  | F      | Caucasian        | 67           | UE            | 33       |
| 1132A>G   | p.N378D  | FALS      | Probable                  | M      | Caucasian        | 37           | B             | 33       |
| 1135T>C   | p.S379P  | FALS      | Definite                  | M      | Pacific Islander | 40           | B             | 38       |
| 1147G>A   | p.I383V  | FALS      | Probable                  | M      | Caucasian        | 66           | B             | 42       |
| 1147G>A   | p.I383V  | FALS      | Definite                  | M      | Caucasian        | 25           | LE            | N/A      |
| 1147G>A   | p.I383V  | FALS      | Probable                  | F      | Caucasian        | 57           | UE            | 50       |
| 1150G>C   | p.G384R  | FALS      | Definite                  | F      | Caucasian        | 45           | UE            | 60       |
| 1168A>G   | p.N390D  | FALS      | Definite                  | M      | Caucasian        | 72           | B             | 33       |

Abbreviations: ALS = amyotrophic lateral sclerosis, SALS = sporadic ALS, FALS = familial ALS, M = male, F = female, B = bulbar, LE = lower extremity, UE = upper extremity, and N/A = not available.





# 14

**“De kwaal van de meeste boeken is dat ze te dik zijn. Wie het verstand aan zijn zijde heeft houdt het kort.”**

Voltaire en de Replubliek.

# Mutational analysis of *TARDBP* in Parkinson's disease

Marka van Blitterswijk, Michael A. van Es, Dagmar Verbaan, Jacobus J. van Hilten,  
Hans Scheffer, Bart P. van de Warrenburg, Jan H. Veldink\*, Leonard H. van den Berg\*

\* Contributed equally to this work.

In preparation.

## Brief communication

Parkinson's disease (PD) is an incurable neurodegenerative disorder, which results from an interaction between multiple genetic and environmental factors, causing a loss of dopaminergic cells in the substantia nigra of the midbrain. Approximately 15-20% of the PD patients report a positive family history, and mutations in several genes are associated with PD, including  $\alpha$ -synuclein (*SNCA*), parkin (*PARK2*), PTEN-induced putative kinase 1 (*PINK1*), DJ-1 (*PARK7*), leucinerich repeat kinase 2 (*LRRK2*), and vacuolar protein sorting 35 (*VPS35*).<sup>1-3</sup>

Recently, PD patients and control subjects of Sardinian descent were also screened for mutations in TAR DNA-binding protein (*TARDBP*), which encodes TDP-43.<sup>4</sup> In eight apparently unrelated PD patients (2.5%) a heterozygous p.A382T mutation was identified. None of their first- or second- degree relatives was affected by PD, dementia, or motor neuron disease (MND). While six of these patients displayed classical PD symptoms, two presented with a postural instability- gait disturbance predominant type of PD, combined with mild cognitive impairment and psychotic phenomena.<sup>4</sup>

Mutations in *TARDBP* were initially reported in patients with amyotrophic lateral sclerosis (ALS), the most frequent form of MND.<sup>5,6</sup> In Sardinia, the p.A382T mutation has been identified in approximately 30% of the ALS patients.<sup>7,8</sup> Furthermore, it has been shown to originate from a common founder.<sup>8</sup> Several of these ALS patients developed extrapyramidal symptoms after their presentation with motor weakness.<sup>8</sup> One Italian patient has also been described with a complex neurological syndrome, consisting of ALS, parkinsonian features, motor- and vocal tics, and frontotemporal dementia (FTD).<sup>9</sup> In addition, Italian families with p.A382T mutations have been reported with cognitive abnormalities and ALS; these patients developed FTD after the onset of ALS.<sup>10</sup>

In The Netherlands, we have shown that *TARDBP* mutations are present in 8.2% of the FALS families.<sup>Chapter 9 of this thesis</sup> One mutation, p.N352S, accounted for more than half of these *TARDBP* mutations. Consequently, we performed extended genealogical analysis and haplotype analysis, and revealed a founder effect, similar to the p.A382T mutation in Sardinia.<sup>8</sup> While the p.A382T mutation was also identified in PD patients of Sardinian descent, we decided to investigate the presence of p.N352S mutations in PD patients of Dutch descent.

Hence, we screened a cohort of 429 PD patients for *TARDBP* mutations in exon six. These PD patients were diagnosed according to the UK Brain Bank criteria,<sup>11</sup> and were obtained at Leiden University Medical Center, and Radboud University Nijmegen Medical

**Table 14.1** Characteristics of study population

| Diagnosis           | Number (n) | Male/female (n) (%) | Age at onset (y) (CI) | Early/late (n) (%) | Positive/negative family history (n) (%) |
|---------------------|------------|---------------------|-----------------------|--------------------|--|
| Parkinson's disease | 429        | 280/149 (65/35)     | 51.9 (50.8-53.0)      | 204/225 (48/52)    | 141/280 (33/67)                          |

Abbreviations: n = number, y = years, and CI = 95% confidence interval.

Center. Their clinical characteristics are shown in Table 14.1. In this cohort, we detected one silent mutation (p.S332S); missense mutations were not identified.

Previously, screening of several other PD cohorts also failed to identify patients with *TARDBP* mutations.<sup>12;23</sup> *TARDBP* mutations have, however, been detected in patients with a wide range of clinical phenotypes. For instance, *TARDBP* mutations (p.N267S and p.M359V) have been identified in Italian patients with the behavioral variant of FTD without signs of MND.<sup>14;15</sup> In addition, a patient with a *TARDBP* mutation (p.K263E) has been described, who developed FTD, supranuclear palsy, and chorea.<sup>16</sup> Moreover, in a cohort of French FTD-MND patients, two FTD-MND patients with *TARDBP* mutations (p.G295S) were discovered. One of these patients had the behavioral variant of FTD, the other patient had semantic dementia, and both these patients developed MND two years after the appearance of FTD symptoms.<sup>17</sup> A patient with a *TARDBP* mutation (p.S393L) and a family history of ALS and parkinsonism has been reported as well, this patient presented with progressive anarthria.<sup>18</sup> Another case report described a patient with a *TARDBP* mutation (p.A382P) and a progressive severe sensory disorder, followed by a motor disorder, which evolved over nine years, and showed mixed sensory and motor neuropathy.<sup>19</sup> Furthermore, a *TARDBP* variant (p.A90V) has been detected in patients with both ALS and FTD, patients with ALS, and patients with Alzheimer's disease (AD); however, this mutation has also been described in control subjects.<sup>20-25</sup>

To summarize, while *TARDBP* mutations are relatively common in ALS patients, and can be detected in a wide range of phenotypes, our results demonstrate that they do not appear to be a cause of PD in The Netherlands.

## References

- (1) Nuytemans K, Theuns J, Cruts M, Van Broeckhoven C. Genetic etiology of Parkinson disease associated with mutations in the SNCA, PARK2, PINK1, PARK7, and LRRK2 genes: a mutation update. *Hum Mutat* 2010;31:763-780.
- (2) Vilarino-Guell C, Wider C, Ross OA et al. VPS35 mutations in Parkinson disease. *Am J Hum Genet* 2011;89:162-167.
- (3) Zimprich A, Benet-Pages A, Struhal W et al. A mutation in VPS35, encoding a subunit of the retromer complex, causes late-onset Parkinson disease. *Am J Hum Genet* 2011;89:168-175.
- (4) Quadri M, Cossu G, Saddi V et al. Broadening the phenotype of TARDBP mutations: the TARDBP Ala382Thr mutation and Parkinson's disease in Sardinia. *Neurogenetics* 2011;12:203-209.
- (5) Kabashi E, Valdmanis PN, Dion P et al. TARDBP mutations in individuals with sporadic and familial amyotrophic lateral sclerosis. *Nat Genet* 2008;40:572-574.
- (6) Sreedharan J, Blair IP, Tripathi VB et al. TDP-43 mutations in familial and sporadic amyotrophic lateral sclerosis. *Science* 2008;319:1668-1672.
- (7) Orru S, Manolakos E, Orru N et al. High frequency of the TARDBP p.Ala382Thr mutation in Sardinian patients with amyotrophic lateral sclerosis. *Clin Genet* 2012;81:172-178.
- (8) Chio A, Borghero G, Pugliatti M et al. Large Proportion of Amyotrophic Lateral Sclerosis Cases in Sardinia Due to a Single Founder Mutation of the TARDBP Gene. *Arch Neurol* 2011;68:594-598.
- (9) Borghero G, Floris G, Cannas A et al. A patient carrying a homozygous p.A382T TARDBP missense mutation shows a syndrome including ALS, extrapyramidal symptoms, and FTD. *Neurobiol Aging* 2011;32:2327.e1-e5.
- (10) Chio A, Calvo A, Moglia C et al. Amyotrophic lateral sclerosis-frontotemporal lobar dementia in 3 families with p.Ala382Thr TARDBP mutations. *Arch Neurol* 2010;67:1002-1009.
- (11) Hughes AJ, Daniel SE, Kilford L, Lees AJ. Accuracy of clinical diagnosis of idiopathic Parkinson's disease: a clinico-pathological study of 100 cases. *J Neurol Neurosurg Psychiatry* 1992;55:181-184.
- (12) Kabashi E, Daoud H, Riviere JB et al. No TARDBP mutations in a French Canadian population of patients with Parkinson disease. *Arch Neurol* 2009;66:281-282.
- (13) Ticozzi N, Leclerc AL, van Blitterswijk M et al. Mutational analysis of TARDBP in neurodegenerative diseases. *Neurobiol Aging* 2011;32:2096-2099.
- (14) Borroni B, Bonvicini C, Alberici A et al. Mutation within TARDBP leads to frontotemporal dementia without motor neuron disease. *Hum Mutat* 2009;30:E974-E983.
- (15) Borroni B, Archetti S, Del Bo R et al. TARDBP mutations in frontotemporal lobar degeneration: frequency, clinical features, and disease course. *Rejuvenation Res* 2010;13:509-517.
- (16) Kovacs GG, Murrell JR, Horvath S et al. TARDBP variation associated with frontotemporal dementia, supranuclear gaze palsy, and chorea. *Mov Disord* 2009;24:1843-1847.

- (17) Benajiba L, Le Ber I, Camuzat A et al. TARDBP mutations in motoneuron disease with frontotemporal lobar degeneration. *Ann Neurol* 2009;65:470-473.
- (18) Praline J, Vourc'h P, Guennoc AM, Veyrat-Durebex C, Corcia P. Co-occurrence of progressive anarthria with an S393L TARDBP mutation and ALS within a family. *Amyotroph Lateral Scler* 2012;13:155-157.
- (19) Camdessanche JP, Belzil VV, Jousserand G et al. Sensory and motor neuropathy in a patient with the A382P TDP-43 mutation. *Orphanet J Rare Dis* 2011;6:4.
- (20) Winton MJ, Van Damme V, Kwong LK et al. A90V TDP-43 variant results in the aberrant localization of TDP-43 in vitro. *FEBS Lett* 2008;582:2252-2256.
- (21) Sreedharan J, Blair IP, Tripathi VB et al. TDP-43 mutations in familial and sporadic amyotrophic lateral sclerosis. *Science* 2008;319:1668-1672.
- (22) Kirby J, Goodall EF, Smith W et al. Broad clinical phenotypes associated with TAR-DNA binding protein (TARDBP) mutations in amyotrophic lateral sclerosis. *Neurogenetics* 2010;11:217-225.
- (23) Kabashi E, Valdmanis PN, Dion P et al. TARDBP mutations in individuals with sporadic and familial amyotrophic lateral sclerosis. *Nat Genet* 2008;40:572-574.
- (24) Guerreiro RJ, Schymick JC, Crews C, Singleton A, Hardy J, Traynor BJ. TDP-43 is not a common cause of sporadic amyotrophic lateral sclerosis. *PLoS One* 2008;3:e2450.
- (25) Brouwers N, Bettens K, Gijssels I et al. Contribution of TARDBP to Alzheimer's disease genetic etiology. *J Alzheimers Dis* 2010;21:423-430.

# 15

**“Waar plaats is voor optellen en aftrekken,  
is plaats voor rede.”**

Thomas Hobbes, Leviathan.



# Paraoxonase gene mutations are not associated with Parkinson's disease

Marka van Blitterswijk, Anna Blokhuis, Pamela Keagle, Ashley Lyn LeClerc, Michael A. van Es, Paulina A. Rowicka, Dagmar Verbaan, Jacobus J. van Hilten, Hans Scheffer, Bart P. van de Warrenburg, Jan H. Veldink\*, Leonard H. van den Berg\*, John E. Landers

\* Contributed equally to this work.

In preparation.

## Abstract

Previously, we have detected paraoxonase (*PON*) mutations in patients with amyotrophic lateral sclerosis (ALS). Mutations in other ALS-associated genes have also been identified in patients with Parkinson's disease (PD). Therefore, we decided to screen a large cohort of PD patients ( $n = 710$ ) and control subjects ( $n = 1,522$ ) for *PON* mutations. We identified *PON* mutations in 3.2% of the PD patients and 2.2% of the control subjects ( $p$ -value 0.16), and thus, we demonstrate that *PON* mutations are not associated with PD susceptibility.

## Introduction

Parkinson's disease (PD) is one of the most common neurodegenerative diseases, and characterized by bradykinesia, muscular rigidity, resting tremor, and postural instability. Less than ten percent of the PD cases can be attributed to mutations in reported loci; the vast majority of the cases are due to complex interactions between genes and environmental factors.<sup>1-4</sup>

Recently, we have identified paraoxonase (*PON*) mutations in patients with amyotrophic lateral sclerosis (ALS).<sup>5,6</sup> Previous studies have already revealed similarities between ALS and PD. TDP-43, for instance, has been identified as the major component of ubiquitinated inclusions (UBIs) in brain tissues from ALS patients,<sup>7</sup> but TDP-43-positive inclusions have also been identified in approximately 7% of the PD cases.<sup>8</sup> Furthermore, mutations in the gene encoding TDP-43 (TAR DNA-binding protein [*TARDBP*]) that were originally reported in ALS patients,<sup>9,10</sup> have also been detected in PD patients.<sup>11</sup> In addition, we have recently shown that angiogenin (*ANG*) mutations are a risk factor for both ALS and PD.<sup>12</sup>

To investigate whether *PON* mutations contribute to the development of PD as well, we decided to screen a large cohort of PD patients (n = 710) and control subjects (n = 1,522) for mutations in *PON*.

## Methods

### Cases

We obtained 281 PD samples at the Coriell Institute for Biomedical Research Cell Repositories and the Massachusetts General Hospital Institute for Neurodegenerative Diseases (United States [US] cohort). All patients met the UK Brain Bank Criteria for PD,<sup>23</sup> and clinical records were reviewed by a neurologist with expertise in movement disorders. DNA was also obtained from 282 control subjects. In addition, we collected DNA of 429 Dutch PD patients at Leiden University Medical Center, and Radboud University Nijmegen Medical Center (Dutch cohort). These patients were also diagnosed according to the UK Brain Bank criteria. Their baseline characteristics are shown in Table 15.1. Control subjects of Dutch descent had already been screened for *PON* mutations.<sup>6</sup> Samples were collected with Institutional Review Board approval, and all participants gave informed consent.

**Table 15.1** Baseline characteristics of study population

| Diagnosis         | Number (n) | Male/female (n) (%) | Age at onset (y) (CI) | Early/late (n) (%) | Positive/negative family history (n) (%) |
|-------------------|------------|---------------------|-----------------------|--------------------|--|
| Dutch PD patients | 429        | 280/149 (65/35)     | 51.9 (50.8-53.0)      | 204/225 (48/52)    | 141/280 (33/67)                          |

Abbreviations: n = number, PD = Parkinson's disease, y = years, and CI = 95% confidence interval.

## Genetic analysis

PD patients and control subjects were screened for mutations in coding regions of *PON1* (NM\_000446) and *PON3* (NM\_000940). Methods and primers used to screen these subjects have been described elsewhere.<sup>5,6</sup> The impact of identified mutations on the structure and function of *PON1* and *PON3* was predicted with PolyPhen-2 (<http://genetics.bwh.harvard.edu/pph2/>) and PMut (<http://mmb2.pcb.ub.es:8080/PMut/>).

## Results

In the US cohort, ten *PON* mutations were present in 5.3% of the PD patients (Table 15.2) and 1.4% of the control subjects (p-value 0.01). Six of these mutations were only detected in PD patients (in *PON1*: p.R32X, p.G51S and p.M127R; in *PON3* p.G18A, p.C42F and p.V166M).

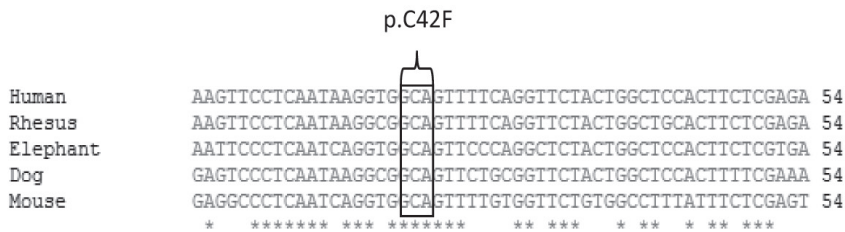
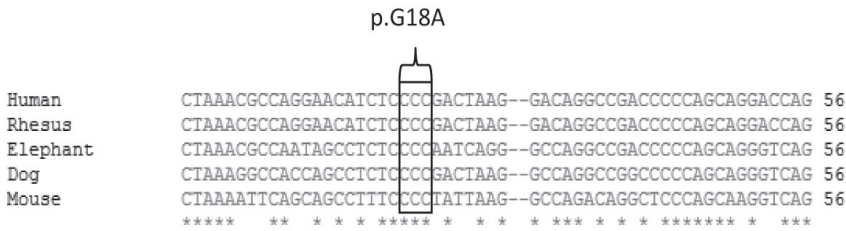
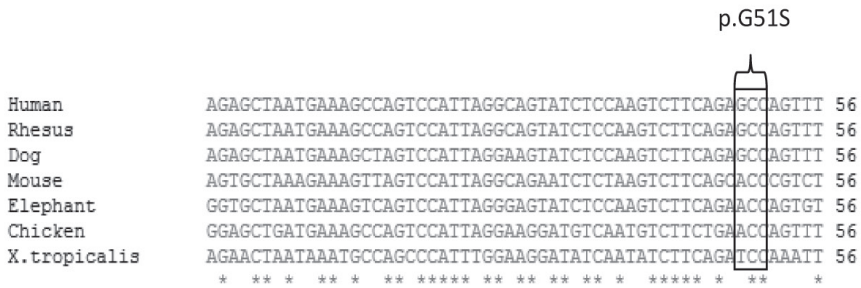
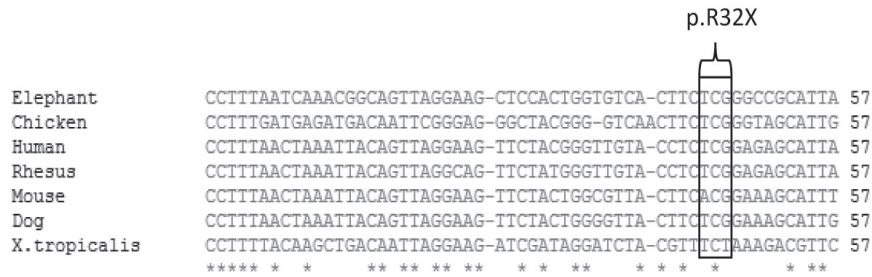
In PD patients and control subjects of Dutch descent eleven *PON* mutations were detected, accounting for 1.9% of the PD patients and 2.4% of the control subjects (p-value 0.58). Five of these mutations were detected in PD patients (in *PON1* p.N19D, p.P40L and p.M127R; in *PON3* p.R32X and p.G324D); however, all these mutations were also present in control subjects (Table 15.1). Furthermore, the p.M127R and p.V166M mutations that were detected in PD patients in the US cohort were also present in control subjects of Dutch descent (Table 15.2).

When both cohorts were combined, *PON* mutations were detected in 3.2% of the PD patients and 2.2% of the control subjects (p-value 0.16). Although *in silico* prediction programs predicted that some of these mutations could have damaging effects, most these mutations were (also) present in control subjects. In addition, we determined the evolutionary conservation of four mutations that were only detected in PD patients, and thereby, we demonstrated that their conservation level is moderate (Figure 15.1).

**Table 15.2** Genetic variation found in *PON*

| Gene         | Mutation | Exon     | US PD<br>(n = 281) | Dutch PD<br>(n = 429) | All PD<br>(n = 710) | US CON<br>(n = 282) | Dutch CON <sup>a</sup><br>(n = 1,240) | All CON<br>(n = 1,522) | PMut              | Prediction        | Prediction<br>PolyPhen-2 |
|--------------|----------|----------|--------------------|-----------------------|---------------------|---------------------|---------------------------------------|------------------------|-------------------|-------------------|--------------------------|
| <i>PON1</i>  | p.N19D   | 1        | 2 (0.7%)           | 2 (0.5%)              | 4 (0.6%)            | 1 (0.4%)            | 2 (0.2%)                              | 3 (0.2%)               | Neutral           | Benign            | Benign                   |
|              | p.R32X   | 2        | 1 (0.4%)           | 0 (0.0%)              | 1 (0.1%)            | 0 (0.0%)            | 0 (0.0%)                              | 0 (0.0%)               | N/A               | N/A               | N/A                      |
|              | p.P40L   | 2        | 0 (0.0%)           | 1 (0.2%)              | 1 (0.1%)            | 0 (0.0%)            | 1 (0.1%)                              | 1 (0.1%)               | Pathological      | Benign            | Benign                   |
|              | p.G51S   | 3        | 1 (0.4%)           | 0 (0.0%)              | 1 (0.1%)            | 0 (0.0%)            | 0 (0.0%)                              | 0 (0.0%)               | Pathological      | Probably damaging | Probably damaging        |
|              | p.M127R  | 5        | 2 (0.7%)           | 1 (0.2%)              | 3 (0.4%)            | 0 (0.0%)            | 6 (0.5%)                              | 6 (0.4%)               | Pathological      | Benign            | Benign                   |
|              | p.A201V  | 6        | 0 (0.0%)           | 0 (0.0%)              | 0 (0.0%)            | 0 (0.0%)            | 3 (0.2%)                              | 3 (0.2%)               | Neutral           | Possibly damaging | Possibly damaging        |
| <i>PON3</i>  | p.G18A   | 1        | 1 (0.4%)           | 0 (0.0%)              | 1 (0.1%)            | 0 (0.0%)            | 0 (0.0%)                              | 0 (0.0%)               | Neutral           | Unknown           | Unknown                  |
|              | p.E19X   | 1        | 0 (0.0%)           | 0 (0.0%)              | 0 (0.0%)            | 0 (0.0%)            | 2 (0.2%)                              | 2 (0.1%)               | N/A               | N/A               | N/A                      |
|              | p.R32X   | 2        | 4 (1.4%)           | 3 (0.7%)              | 7 (1.0%)            | 1 (0.4%)            | 5 (0.4%)                              | 6 (0.4%)               | N/A               | N/A               | N/A                      |
|              | p.C42F   | 2        | 1 (0.4%)           | 0 (0.0%)              | 1 (0.1%)            | 0 (0.0%)            | 0 (0.0%)                              | 0 (0.0%)               | Pathological      | Probably damaging | Probably damaging        |
|              | p.D121N  | 4        | 0 (0.0%)           | 0 (0.0%)              | 0 (0.0%)            | 0 (0.0%)            | 1 (0.1%)                              | 1 (0.1%)               | Neutral           | Possibly damaging | Possibly damaging        |
|              | p.V166M  | 6        | 3 (1.1%)           | 0 (0.0%)              | 3 (0.4%)            | 0 (0.0%)            | 1 (0.1%)                              | 1 (0.1%)               | Neutral           | Possibly damaging | Possibly damaging        |
|              | p.T186S  | 6        | 0 (0.0%)           | 0 (0.0%)              | 0 (0.0%)            | 0 (0.0%)            | 1 (0.1%)                              | 1 (0.1%)               | Neutral           | Benign            | Benign                   |
|              | p.L258Q  | 7        | 0 (0.0%)           | 0 (0.0%)              | 0 (0.0%)            | 0 (0.0%)            | 1 (0.1%)                              | 1 (0.1%)               | Pathological      | Benign            | Benign                   |
|              | p.P285A  | 8        | 0 (0.0%)           | 0 (0.0%)              | 0 (0.0%)            | 1 (0.4%)            | 0 (0.0%)                              | 1 (0.1%)               | Neutral           | Probably damaging | Probably damaging        |
|              | p.N308D  | 9        | 0 (0.0%)           | 0 (0.0%)              | 0 (0.0%)            | 1 (0.4%)            | 0 (0.0%)                              | 1 (0.1%)               | Neutral           | Benign            | Benign                   |
| p.G324D      | 9        | 0 (0.0%) | 1 (0.2%)           | 1 (0.1%)              | 0 (0.0%)            | 7 (0.6%)            | 7 (0.5%)                              | Pathological           | Probably damaging | Probably damaging |                          |
| <b>Total</b> |          |          | 15 (5.3%)          | 8 (1.9%)              | 23 (3.2%)           | 4 (1.4%)            | 30 (2.4%)                             | 34 (2.2%)              |                   |                   |                          |

Abbreviations: US = United States, CON = control subjects, and N/A = not applicable. Mutation frequencies were compared between patients and control subjects with Fisher's exact test or Chi-square test (GraphPad Prism version 5, <http://www.graphpad.com>). The difference between PD patients and control subjects in the US cohort is significant (p-value 0.01), while there is no significant difference in the Dutch cohort, or when both cohorts are combined. <sup>a</sup> The mutation frequency in control subjects of Dutch descent has been reported previously.<sup>6</sup>



**Figure 15.1** Evolutionary conservation of *PON* mutations unique for PD patients. Conservation of nucleotides across species was generated using ClustalW2 online tool, <http://www.ebi.ac.uk/Tools/msa/clustalw2/>. See Appendix page 386 for Figure 15.1 in color.

## Discussion

In our present study, we have detected *PON* mutations in 3.2% of the PD patients and 2.2% of the control subjects (p-value 0.16). Therefore, we demonstrate that *PON* mutations are not associated with PD. Because of its positive effects on oxidation and the detoxification of neurotoxins,<sup>14-16</sup> single nucleotide polymorphisms (SNPs) in *PON* have already been investigated in PD patients. It has been shown, for instance, that carriers of MM genotypes in a major *PON* SNP (p.L55M) that were exposed to organophosphates, exhibited a greater than two-fold increase in PD risk as compared to persons who had the wild-type or heterozygous genotype without exposure.<sup>17</sup> Moreover, lower PON1 activities were detected in PD patients, than in control subjects and carriers of the risky polymorphisms as compared to other PD patients.<sup>18</sup> A meta-analysis of all available studies relating p.Q192R and p.L55M and the risk of developing PD, showed that there was an association with the M allele at position 55 (odds ratio 1.32 (confidence interval [CI] 1.1-1.6)), but no significant association for p.Q192R.<sup>19</sup> A recent study that assessed a large cohort of PD patients, however, contradicted these results, and reported a lack of association between the two major *PON* SNPs and PD.<sup>20</sup>

In ALS patients, several studies have also reported that *PON* SNPs are associated with ALS, while others, including a large-scale international meta-analysis, contradicted these results.<sup>21-28</sup> Previously, we have also detected *PON* mutations in ~2.5% of the familial ALS cases and ~0.3% of the sporadic ALS cases.<sup>5</sup> In a large cohort of Dutch ALS patients, however, we were unable to replicate these findings.<sup>6</sup>

Thus, although associations between *PON* and neurodegenerative diseases have been reported, most studies that investigated larger cohorts of patients could not confirm these findings. Our present study supports these negative studies, and demonstrates that *PON* mutations are not associated with PD.

## References

- (1) Venda LL, Cragg SJ, Buchman VL, Wade-Martins R. alpha-Synuclein and dopamine at the crossroads of Parkinson's disease. *Trends Neurosci* 2010;33:559-568.
- (2) Lesage S, Brice A. Parkinson's disease: from monogenic forms to genetic susceptibility factors. *Hum Mol Genet* 2009;18:R48-R59.
- (3) Morley JF, Hurtig HI. Current understanding and management of Parkinson disease: five new things. *Neurology* 2010;75:S9-15.
- (4) Hardy J. Genetic analysis of pathways to Parkinson disease. *Neuron* 2010;68:201-206.

- (5) Ticozzi N, Leclerc AL, Keagle PJ et al. Paraoxonase gene mutations in amyotrophic lateral sclerosis. *Ann Neurol* 2010;68:102-107.
- (6) van Blitterswijk M, Blokhuis A, van Es MA et al. Rare and common paraoxonase gene variants in amyotrophic lateral sclerosis patients. *Neurobiol Aging* 2012 Feb 11.
- (7) Neumann M, Sampathu DM, Kwong LK et al. Ubiquitinated TDP-43 in frontotemporal lobar degeneration and amyotrophic lateral sclerosis. *Science* 2006;314:130-133.
- (8) Nakashima-Yasuda H, Uryu K, Robinson J et al. Co-morbidity of TDP-43 proteinopathy in Lewy body related diseases. *Acta Neuropathol* 2007;114:221-229.
- (9) Kabashi E, Valdmanis PN, Dion P et al. TARDBP mutations in individuals with sporadic and familial amyotrophic lateral sclerosis. *Nat Genet* 2008;40:572-574.
- (10) Sreedharan J, Blair IP, Tripathi VB et al. TDP-43 mutations in familial and sporadic amyotrophic lateral sclerosis. *Science* 2008;319:1668-1672.
- (11) Quadri M, Cossu G, Saggi V et al. Broadening the phenotype of TARDBP mutations: the TARDBP Ala382Thr mutation and Parkinson's disease in Sardinia. *Neurogenetics* 2011;12:203-209.
- (12) van Es MA, Schelhaas HJ, van Vught PW et al. Angiogenin variants in Parkinson disease and amyotrophic lateral sclerosis. *Ann Neurol* 2011;70:964-973.
- (13) Hughes AJ, Daniel SE, Kilford L, Lees AJ. Accuracy of clinical diagnosis of idiopathic Parkinson's disease: a clinico-pathological study of 100 cases. *J Neurol Neurosurg Psychiatry* 1992;55:181-184.
- (14) Costa LG, Vitalone A, Cole TB, Furlong CE. Modulation of paraoxonase (PON1) activity. *Biochem Pharmacol* 2005;69:541-550.
- (15) Draganov DI, Stetson PL, Watson CE, Billecke SS, La Du BN. Rabbit serum paraoxonase 3 (PON3) is a high density lipoprotein-associated lactonase and protects low density lipoprotein against oxidation. *J Biol Chem* 2000;275:33435-33442.
- (16) Ng CJ, Wadleigh DJ, Gangopadhyay A et al. Paraoxonase-2 is a ubiquitously expressed protein with antioxidant properties and is capable of preventing cell-mediated oxidative modification of low density lipoprotein. *J Biol Chem* 2001;276:44444-44449.
- (17) Manthripragada AD, Costello S, Cockburn MG, Bronstein JM, Ritz B. Paraoxonase 1, agricultural organophosphate exposure, and Parkinson disease. *Epidemiology* 2010;21:87-94.
- (18) BenMoyal-Segal L, Vander T, Shifman S et al. Acetylcholinesterase/paraoxonase interactions increase the risk of insecticide-induced Parkinson's disease. *FASEB J* 2005;19:452-454.
- (19) Zintzaras E, Hadjigeorgiou GM. Association of paraoxonase 1 gene polymorphisms with risk of Parkinson's disease: a meta-analysis. *J Hum Genet* 2004;49:474-481.
- (20) Wingo TS, Rosen A, Cutler DJ, Lah JJ, Levey AI. Paraoxonase-1 polymorphisms in Alzheimer's disease, Parkinson's disease, and AD-PD spectrum diseases. *Neurobiol Aging* 2012;33:204.e13-e15.
- (21) Valdmanis PN, Kabashi E, Dyck A et al. Association of paraoxonase gene cluster polymorphisms with ALS in France, Quebec, and Sweden. *Neurology* 2008;71:514-520.



- (22) Cronin S, Greenway MJ, Prehn JH, Hardiman O. Paraoxonase promoter and intronic variants modify risk of sporadic amyotrophic lateral sclerosis. *J Neurol Neurosurg Psychiatry* 2007;78:984-986.
- (23) Morahan JM, Yu B, Trent RJ, Pamphlett R. A gene-environment study of the paraoxonase 1 gene and pesticides in amyotrophic lateral sclerosis. *Neurotoxicology* 2007;28:532-540.
- (24) Slowik A, Tomik B, Wolkow PP et al. Paraoxonase gene polymorphisms and sporadic ALS. *Neurology* 2006;67:766-770.
- (25) Saeed M, Siddique N, Hung WY et al. Paraoxonase cluster polymorphisms are associated with sporadic ALS. *Neurology* 2006;67:771-776.
- (26) Landers JE, Shi L, Cho TJ et al. A common haplotype within the PON1 promoter region is associated with sporadic ALS. *Amyotroph Lateral Scler* 2008;9:306-314.
- (27) Ricci C, Battistini S, Cozzi L et al. Lack of association of PON polymorphisms with sporadic ALS in an Italian population. *Neurobiol Aging* 2011;32:552.e7-e13.
- (28) Wills AM, Cronin S, Slowik A et al. A large-scale international meta-analysis of paraoxonase gene polymorphisms in sporadic ALS. *Neurology* 2009;73:16-24.





# **PART III**

## **Functional studies**



# 16

**“Voor de meeste feiten kan ik evenwel niet instaan. Liever leg ik de verantwoordelijkheid bij mijn bronnen.”**

Plinius, De wereld, Naturalis Historia.

# RNA processing pathways in amyotrophic lateral sclerosis

Marka van Blitterswijk, John E. Landers

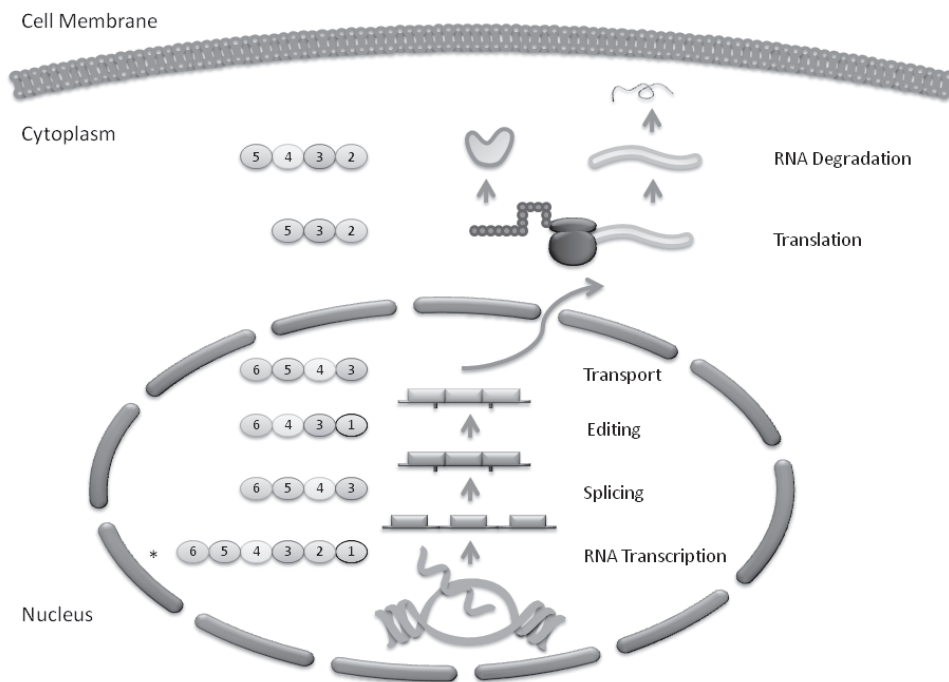
*Neurogenetics* 2010 Jul;11(3):275-290.

## Summary

RNA processing is a tightly-regulated, highly complex pathway, which includes RNA transcription, pre-mRNA splicing, editing, transportation, translation and degradation of RNA. Over the past few years, several RNA processing genes have been shown to be mutated or genetically associated with amyotrophic lateral sclerosis (ALS), for instance, RNA-binding proteins TDP-43 and fused in sarcoma/translated in liposarcoma (FUS/TLS). This suggests that RNA processing may represent a common pathogenic mechanism involved in the development of ALS. In this review, we will discuss six ALS-related RNA processing genes, including their discovery, function, and commonalities.

## Introduction

Amyotrophic lateral sclerosis (ALS) is a devastating fatal neurodegenerative disease, which typically develops in the fifth or sixth decade of life and has a survival of less than five years.<sup>1-3</sup> The etiology of ALS is complex, combining both environmental- and genetic factors. Since the discovery of superoxide dismutase-1 (*SOD1*) in 1993 as a cause of ~20% of familial cases,<sup>4</sup> several genes have been identified as a cause or risk-factor for ALS.<sup>5</sup> Interestingly, a common theme for several ALS-related genes is a role in RNA processing pathways. RNA processing is a highly-regulated pathway that includes RNA transcription, removal of non-coding introns by pre-mRNA splicing, editing, transportation, translation and degradation (Figure 16.1). Numerous proteins and regulatory RNAs are involved in RNA processing; splicing, for instance, is mediated by the spliceosome, consisting of small nuclear ribonucleoprotein complexes (snRNPs) and splicing factors like RNA-binding proteins (RBPs, e.g. heterogeneous nuclear RNPs [hnRNPs]) and enzymes (e.g. helicases). In this review we will discuss the role of six RNA processing genes implicated in ALS and other motor neuron diseases (Table 16.1).



\* ELP3=1, ANG=2, SETX=3, SMN=4, TDP-43=5 and FUS/TLS=6

**Figure 16.1** ALS-related genes in the RNA processing pathway. See Appendix page 387 for Figure 16.1 in color.

**Table 16.1** Role of ALS genes in RNA processing

| Gene           | RNA transcription regulation | RNA transcription                 | RNA splicing       | RNA post-transcriptional processing/editing | RNA transport | RNA translation regulation | RNA degradation |
|----------------|------------------------------|-----------------------------------|--------------------|---|---------------|----------------------------|-----------------|
| <i>ANG</i>     | rRNA, tRNA                   |                                   |                    |   |               | <i>Initiator</i>           | tRNA RNase      |
| <i>ELP3</i>    | Histone acetylation          | Part of RNA polymerase II complex |                    | tRNA  |               |                            |                 |
| <i>FUS/TLS</i> | mRNA                         |                                   | Splicing factor    | Maturation mRNA                             | mRNA          |                            |                 |
| <i>SETX</i>    | RNA helicase                 |                                   | mRNA               | tRNA, rRNA, snRNA, mRNA                     | mRNA          | <i>Initiator</i>           | mRNA            |
| <i>SMN</i>     | mRNA                         |                                   | mRNA               | rRNA, mRNA                                  | mRNA          |                            | mRNA            |
| <i>TARDBP</i>  | mRNA                         |                                   | Splicing inhibitor |   | mRNA          | Repressor                  | mRNA            |

Abbreviations: rRNA = ribosomal RNA, tRNA = transfer RNA derived, stress-induced small RNA, mRNA = messenger RNA, tRNA = transfer RNA, and snRNA = small nuclear RNA. Suggested roles are shown in *italic*.



## Angiogenin (ANG)

ANG is a 14.1 kDa protein that belongs to the pancreatic ribonuclease superfamily. Mutations in *ANG* were originally identified in both familial and sporadic ALS cases in the Irish and Scottish population.<sup>6</sup> Subsequently, more than fifteen variants in the *ANG* gene have been reported.<sup>7-12</sup> ANG is a downstream effector of Vascular Endothelial Growth Factor (VEGF) in endothelial cells and is up-regulated in response to hypoxic/ischemic events.<sup>13</sup> The expression of *ANG* is widespread, including vascular endothelial cells, fibroblasts, mast cells and tumor cells.<sup>14;15</sup> Recently, *ANG* was also shown to be expressed by neurons in rat brain and motor neurons in humans.<sup>16</sup>

Endothelial cells are capable of endocytosing ANG; subsequently, ANG is translocated to the nucleus and accumulates in the nucleolus.<sup>17;18</sup> ANG contains four Ribonuclease A (RNase A) residues that are critical for enzymatic activity; three residues form the catalytic apparatus (His-13, Lys-40 and His-114), and a fourth (Thr-44) is present within a pyrimidine-binding component.<sup>19</sup> In addition, ANG contains a nuclear localization signal (NLS [residue 31-35]) and a signal peptide (residue 1-24). The ribonucleolytic activity of ANG is weak; approximately 100-fold lower than bovine RNase A.

Several lines of evidence demonstrate that the ANG protein promotes motor neuron survival. Knockdown of *ANG* expression causes excitotoxic motor neuron death, whereas increased expression of *ANG* protects against stress-induced cell death.<sup>20</sup> In the *SOD1*<sup>G93A</sup> ALS mouse model, ANG delivery increases lifespan and motor neuron survival, possibly through the Akt-1 signaling pathway.<sup>20</sup> The neuroprotective effects of ANG are absent when *ANG* is mutated.<sup>20;21</sup> Hypoxic/ischemic events appear to activate ANG,<sup>13;21</sup> and ANG is a known target gene of hypoxia-inducible factor-1 (HIF-1), which causes up-regulation of both ANG mRNA and ANG protein in motor neurons.<sup>21</sup> It has also been shown that a modest elevation in serum ANG in ALS patients can be seen at time of diagnosis.<sup>22</sup> Interestingly, a lack of up-regulation of *ANG* has been shown during hypoxemia in cerebrospinal fluids (CSF) of ALS patients.<sup>23</sup> ANG can also be detected in growth cones and neurite outgrowths and plays an important role in neurite extension and pathfinding. Mutations in *ANG*, or exposure to the ANG inhibitor 65828, have even been shown to inhibit neurite pathfinding.<sup>24;25</sup> Interestingly, ANG has been extensively genetically associated with numerous disorders including many carcinomas,<sup>26-34</sup> diabetes mellitus,<sup>35-37</sup> asthma,<sup>38;39</sup> chronic heart failure<sup>40</sup> and endometriosis.<sup>41-43</sup>

ANG can also act as a cytotoxic transfer RNA (tRNA)-specific RNase<sup>44</sup> capable of degrading tRNAs *in vivo*.<sup>45</sup> This function is thought to eliminate redundant tRNA molecules. Furthermore, it has been shown that ANG is required for tRNA derived

production of stress-induced small RNAs (tiRNAs), and that knockdown of *ANG* inhibits arsenite-induced tiRNA production and causes translational arrest.<sup>46</sup> Consequently, secreted *ANG* may activate a stress response program that allows stressed cells to warn for noxious stimuli.<sup>46</sup> *ANG* is also a regulator of ribosomal RNA (rRNA) transcription.<sup>47,48</sup> Since rRNA transcription is the rate-limiting step in ribosome biogenesis and a supply of ribosomes, and protein synthesis is required to allow sustained cell growth and new blood vessel formation, *ANG* mutations could potentially cause deregulation of protein synthesis, and thereby, neoplastic transformation.<sup>49</sup> It has already been shown that mutant *ANG* proteins are unable to induce angiogenesis because of a deficiency in RNase activity or nuclear translocation.<sup>12</sup> Thus, this loss-of-function most likely contributes to ALS as well.

## Elongator protein 3 (*ELP3*)

The *ELP3* gene has been associated with an increased susceptibility to sporadic ALS (SALS), and risk-associated *ELP3* alleles correlate with lower *ELP3* expression in human brain tissues.<sup>50</sup> Supporting this association, two loss-of-function mutations in the *Drosophila ELP3* result in abnormal axonal targeting and synaptic development. Additionally, *ELP3* knockdown in zebrafish-embryos results in shortening and abnormal branching of motor neurons.<sup>50</sup> Lastly, silencing of *ELP3* in mice results in delayed migration and impairs the branching of projection neurons.<sup>51</sup>

*ELP3* is part of the Elongator-complex, also known as holo-Elongator.<sup>52</sup> Elongator is a component of the RNA polymerase II complex and consists of a core unit of *ELP1*, *ELP2* and *ELP3*, and a smaller unit of *ELP4*, *ELP5* and *ELP6*.<sup>53</sup> Elongator can acetylate histone H<sub>3</sub> and to a lesser extent H<sub>4</sub> to make DNA accessible for transcription.<sup>54</sup> In addition, Elongator is also necessary for post-transcriptional processing of tRNA, and *ELP1* to *ELP3* are especially important for uridine modification at the wobble position in tRNA.<sup>55</sup> Interestingly, mutations in IκB kinase complex-associated protein (*IKAP*), a component of Elongator and a homologue of *ELP1* in humans, lead to the development of familial dysautonomia (FD), a hereditary sensory and autonomic neurodegenerative disease.<sup>56</sup>

*ELP3* is crucial for the integrity of holo-Elongator and essential for RNA-binding.<sup>57-59</sup> It possesses an N-terminal iron-sulfur (FeS) cluster motif and a C-terminal histone acetyltransferase (HAT) elongation domain. *ELP3* also regulates the expression of heat shock protein 70 (*HSP70*) by acetylation of histone H<sub>3</sub>.<sup>60</sup> *HSP70* is implicated in several processes, including stabilization of protein structure, prevention of aggregation, regulation of protein activity and protection against apoptosis.<sup>60</sup> These observations

suggest that the association of lower *ELP3* expression with SALS, may be due to an increase of motor neuron susceptibility to cellular stress.

## Fused in sarcoma / translated in liposarcoma (*FUS/TLS*)

Mutations in *FUS/TLS* have been reported in familial ALS (FALS) patients.<sup>61,62</sup> Kwiatkowski et al. described a loss-of-heterozygosity (LOH) cluster on chromosome sixteen in a family of Cape Verdean origin. The p.H517Q variant in exon fifteen of the *FUS/TLS* gene was revealed by genomic sequencing, and additional sequencing resulted in thirteen different mutations in seventeen FALS families, ten of which are located in exon fifteen. Vance et al. previously reported linkage to a 42-Mb region on chromosome sixteen in a large multigenerational British kindred,<sup>63</sup> and subsequently detected a p.R521C mutation in exon fifteen of *FUS/TLS*. Additional screening resulted in detection of the same mutation in four other families, and detection of two other mutations in another four families, one in exon fifteen and one in exon thirteen. Currently, *FUS/TLS* mutations (including five novel mutations) have been identified in families of Italian, Japanese, Dutch and German origin, and in SALS and FALS in the French and French-Canadian population.<sup>64-69</sup> Combining data from these studies results in a *FUS/TLS* mutation frequency of approximately ~4% of FALS patients.

*FUS/TLS* is 526 amino acids long, and characterized by an N-terminal serine, tyrosine, glycine and glutamine (SYGQ)-rich region, an RNA-recognition motif (RRM), a C2/C2 zinc finger motif, multiple RGG-repeat regions and a NLS at the extreme C-terminus. A vast majority of the ALS mutations occur in the NLS and result in cytoplasmic retention of the *FUS/TLS* protein.<sup>61,62</sup> The zinc finger motif binds the DGP-bound form of Ran GTPase, participates in trafficking through the nuclear membrane and is also able to bind GGUG-containing RNA both *in vitro* and *in vivo*.<sup>70-72</sup> The specificity of this RNA interaction is mediated by RGG boxes and the RRM.<sup>71</sup> Originally, *FUS/TLS* was identified as translocation t (12; 16) (q13: p11) in myxoid liposarcoma, consisting of N-terminal parts of *FUS/TLS* juxtaposed to the DNA-binding parts of transcription factor *CHOP*.<sup>73</sup> The *FUS/TLS* domain is a key determinant in developing human liposarcomas, since transgenic mice expressing a fusion of *FUS/TLS* domain to *CHOP* develop liposarcomas, whereas a lack of *FUS/TLS* activation domain does not generate tumors.<sup>74</sup>

*FUS/TLS* is also known as hnRNP P2<sup>75</sup> and belongs to a family with Ewing's sarcoma (EWS) and TATA-binding protein-associated factor (TAFII68) called TET or FET (*FUS/TLS*, EWS, TAFII68). Both *FUS/TLS* and TAFII68 are present in Polymerase II transcription complexes suggesting a role in the transcription process.<sup>76</sup> Furthermore, it has been

shown that FUS/TLS and EWS associate *in vivo* with products of RNA polymerase II transcription to form complexes with hnRNPs like A1 and C1/C2.<sup>77</sup> FUS/TLS is also a component of RNA granules that transport dendritic mRNAs<sup>78</sup> and associates with an actin-dependent motor protein myosin Va (MyoVa).<sup>79;80</sup> Additionally, FUS/TLS associates with the N-methyl-D-aspartate receptor 1 (NMDA receptor 1 (NR1)) complex that is translocated in neurites and appears to play a role in its trafficking.<sup>79</sup> The hypothesis that FUS/TLS functions as a chaperone of RNA is supported by analysis of interspecific heterokaryons formed between human and mouse or *Xenopus* cells that confirms FUS/TLS engages in rapid nucleocytoplasmic shuttling.<sup>72</sup>

In addition, FUS/TLS is a partner of Spi-1, required for the development of myeloid and B-lymphoid lineages, and influences the alternative splice sites in erythroid cells, thus interfering with gene transcription regulation and maturation of pre-mRNA.<sup>81</sup> FUS/TLS also interacts with the transcription factor nuclear factor kB (NF-kB), regulating transcriptionally active members such as c-Rel, RelA (p65) and RelB and DNA-binding subunits NF-kB1 (p50/p105) and NFkB2 (p52/p100).<sup>82;83</sup> Furthermore, FUS/TLS inhibits the acetyltransferase activities of CREB-binding protein (CBP) and p300 on cyclin D1 (CCND1) in human cell lines. Both CBP and p300 are co-activators of multiple classes of signal dependent transcription factors and FUS/TLS-CPB/p300 interactions could result in the inhibition of HAT and the repression of transcription.<sup>84</sup> Moreover, FUS/TLS forms a complex with splicing factors like serine-arginine (SR) proteins (SC35, SRp75 and TLS-associated SR protein [TASR]), SRm160 and PTB; and removal of FUS/TLS from the nuclear extract causes a disturbance of the splicing factor equilibrium, thereby interrupting the splicing machinery.<sup>85;86</sup> Cells over-expressing Green Fluorescent Protein (GFP)-tagged *FUS/TLS* show cytoplasmic aggregates that co-localize with the stress granule marker TIA-1, indicating involvement in the cellular stress response.<sup>87</sup> FUS/TLS also modulates the stress-induced Y-box binding-1 (YB-1) transcription factor by activation of the MMP-1 gene. YB-1 is involved in transcriptional regulation and mRNA processing, and is activated by cytotoxic and genotoxic stress, whereby it binds to the single stranded response element (RE-1), the Y-box or inverted CCAAT box.<sup>88</sup>

## Senataxin (*SETX*)

Mutations in the *SETX* gene result in an autosomal dominant form of juvenile ALS,<sup>89</sup> with slow progressive distal muscle weakness and an onset prior to 25 years of age. In addition, a novel mutation in *SETX* was recently identified in a Chinese patient with SALS.<sup>90</sup> Mutations in *SETX* were originally reported in another neurodegenerative

disease called ataxia-oculomotor apraxia type 2 (AOA2).<sup>91</sup> AOA is an autosomal recessive disease characterized by a slowly progressive degeneration of the cerebellum, spinal cord and peripheral nerves, causing ocular apraxia, cerebellar ataxia and sensory-motor neuropathy. To date more than fifty mutations in AOA patients have been reported.<sup>91-98</sup>

*SETX* encodes a 302.8-kDa protein consisting of 2677 amino acids that is ubiquitously expressed.<sup>65;89</sup> *SETX* is diffusely present in the cytoplasm and discrete regions in the nucleus.<sup>99</sup> The C-terminus of *SETX* contains a classical seven-motif domain characteristic for RNA/DNA helicases. DNA helicases can unwind long double stranded DNA, while RNA helicases have the ability to unwind folded RNAs and modify RNA-RNA interactions. RNA helicases are frequently found in large ribonucleoprotein (RNP) complexes with a generic catalytic core and a specific external surface. In comparison with DNA helicases, processive unwinding activity of RNA helicases is uncommon, since continuous double stranded RNA is rare. In general, helicases maintain the genome integrity and are involved in many processes including replication, transcription, ribosome biogenesis, pre-mRNA editing and splicing, RNA export to the cytoplasm, translation initiation and termination, RNA degradation, organelle gene expression, recombination, repair and virus propagation.<sup>100;101</sup> Helicases could potentially function in these processes by modification of protein interactions or conformations, or as energy-dependent enzymes to drive reactions.<sup>101</sup>

*SETX* has strong homology to Regulator of Nonsense Transcripts-1 (*RENT1* or *UPF1*), Immunoglobulin Mu-Binding Protein 2 (*IGHMBP2*) and Splicing endonuclease 1 (*Sen1p*), all involved in RNA processing. *RENT1/Upf1* is involved in mRNA nuclear export and nonsense mediated mRNA decay. Inhibition of *RENT1/Upf1* expression results in abrogation of both nonsense-mediated mRNA decay (NMD) and nonsense-mediated altered splicing (NAS),<sup>102</sup> which alters gene expression by affecting the amount of cytoplasmic mRNA.<sup>103</sup> *IGHMBP2* is a 993 amino acid protein that is ubiquitously expressed, predominantly in the cytoplasm, and contains a RNA/DNA helicase domain. It has been shown that *IGHMBP2* is both involved in ATP-dependent unwinding of DNA and RNA.<sup>104</sup> *IGHMBP2* mutations have been detected in an autosomal recessive neurodegenerative disease, called spinal muscular atrophy with respiratory distress type 1 (*SMARD1*) that affects the unwinding activity and can therefore lead to severely reduced steady-state protein levels *in vivo*.<sup>104-106</sup> *Sen1p* is a 252 kDa protein that is exclusively nuclear and has helicase activity. It is involved in processing tRNA, rRNA and small nuclear RNA (snRNA), and in addition, it is essential for growth.<sup>107</sup> Mutations in *Sen1p* alter the genome-wide distribution of RNA polymerase II and cause transcription termination.<sup>107;108</sup> Furthermore, *Sen1p* interacts with RNA polymerase II subunit Rpo21p and endonuclease Rad2p, both required for nucleotide excision repair after DNA damage. It has been shown that

Sen1p and Rad2p double mutants are hypersensitive to ultraviolet (UV) radiation,<sup>107</sup> and interestingly, AOA2 SETX cells have an increased sensitivity to hydrogen peroxide (H<sub>2</sub>O<sub>2</sub>), camptothecin (CPT) and mitomycin C (MMC), proposing a role for SETX in DNA repair.<sup>109</sup>

## Survival motor neuron (*SMN*)

Spinal muscular atrophy (SMA) is an autosomal recessive neurodegenerative disease that affects motor neurons in the anterior horns of the spinal cord, causing muscular atrophy and paralysis. *SMN* has been identified as the SMA determining gene, encoding the SMN protein.<sup>110</sup> Humans contain two copies of the *SMN* gene; *SMN1* and *SMN2* are located on chromosome 5q13 with *SMN1* on the telomeric side. *SMN2* differs from *SMN1* by a C to T transition in exon seven.<sup>110-112</sup> This transition results in a predominant skipping of exon seven in the *SMN2* transcript, and is regulated by hnRNP A1-dependent splicing silencing elements (ESSs), hnRNP Q and TDP-43.<sup>113-115</sup> The protein product of the exon seven-skipped *SMN2* transcript has a decreased ability to oligomerize and is rapidly degraded.<sup>110,116-119</sup> Mutations or deletions of the *SMN1* results in SMA, due to the fact that *SMN2* cannot compensate for impaired SMN production.<sup>110</sup> Interestingly, patients with milder forms of SMA generally carry more copies of the *SMN2* gene compared to patients with more severe SMA, possibly enhancing their ability to compensate.<sup>120</sup>

Abnormal copy number of the *SMN1* gene has also been genetically associated with the risk of developing ALS.<sup>121-123</sup> In contrast, differing results have been reported for an association between *SMN2* deletions and the risk of developing ALS.<sup>121,123</sup> These conflicting results could be due to variable phenotype definitions, inclusion criteria, random fluctuations, relatively rare polymorphisms, ethnic differences, cohort sizes and variations in control populations.<sup>121,123,124</sup>

The SMN protein is 294 amino acids long and found in the cytoplasm and nucleus, especially in discrete Gemini of Cajal bodies (Gems).<sup>125</sup> In these Cajal bodies, RNA maturation and snRNA modification takes place.<sup>126</sup> SMN is part of an assemblyosome called the SMN complex, consisting of SMN and Gemin2-7 proteins. Gemin2 is tightly associated with SMN, Gemin3 is a DEAD-box RNA helicase, Gemin4 a component of microRNPs, Gemin5 a multi-domain WD-repeat-containing protein that recognizes snRNAs, and Gemin6 and 7 contain a Sm-fold domain.<sup>127,128</sup> The assembly function of the SMN complex is chaperoned by pICln, part of the protein arginine methyltransferase 5 (PRMT5) complex. pICln prevents the association of Sm proteins with snRNA,<sup>129</sup> allowing binding of the SMN complex to a common set of seven Sm proteins (SmB/B', SmD1, SmD2, SmD3, SmE, SmF and SmG). Subsequently, the SMN complex transfers these

proteins to the uridine-rich Sm site of snRNAs to create the ring-shaped core domain of snRNPs. After hypermethylation of the 5' cap, the newly formed snRNPs are imported into the nucleus by snurportin and importin beta to Cajal bodies for further maturation and utilization in splicing.<sup>139</sup> This assemblyosome activity is up-regulated by overexpression of wild-type *SMN* and decreases in cells expressing *SMN* mutants.<sup>131</sup> It has also been shown that the SMN complex interacts with nuclear phosphatases PPM1G/PP2Cgamma and PPP4, which influence the localization of snRNPs and SMN.<sup>132,133</sup> In addition, SMN interacts with proteins such as Sm-like (Lsm) proteins, fibrillarin, GAR1, nucleolin, hnRNP-R, gry-rbp/hnRNP-Q, coilin and KH-type splicing regulatory protein (KSRP), involved in processes like mRNA editing, transport, splicing, transcriptional regulation, mRNA decay and post-transcriptional processing and modification of rRNA.<sup>134-138</sup> Therefore, it is not surprising that SMN deficiency alters the stoichiometry of snRNAs and causes widespread pre-mRNA splicing deficits in numerous transcripts of diverse genes.<sup>59</sup>

In SMA mice, the role of SMN has been intensively studied. The earliest structural defects in SMA mice appear distally and involve the neuromuscular synapse, impairing maturation of acetylcholine receptors (AChR) and leading to poor terminal arborization and filament aggregates.<sup>139,140</sup> Furthermore, a significant increase in synapses lacking motor axon input has been detected, indicating denervation in embryogenesis.<sup>141</sup> It has also been shown that snRNP assembly and the expression of Gemin proteins are dramatically reduced in spinal cord of severe SMA mice, and that the extent of this reduction correlates with disease severity.<sup>142</sup> Additionally, two novel SMN mutations also cause nonsense-mediated mRNA decay, a decrease in SMN protein levels and the development of a SMA phenotype.<sup>143</sup> Transgenic mutant *SOD1* mice on a SMN deficient background have been generated as well. These mice demonstrated a significant decrease in motor performance and survival compared to transgenic *SOD1*<sup>G93A</sup> mice. In contrast, transgenic *SOD1* wild-type overexpression in SMA type I mice is incapable of modulating SMN protein levels or disease progression, suggesting that SMN deficiency acts as an enhancing genetic modifier in ALS.<sup>144</sup>

## TAR DNA-binding protein (*TARDBP*)

The presence of protein aggregates in the central nervous system is a neuropathological hallmark of neurodegenerative diseases. In ALS patients, the major component of these aggregates is hyper-phosphorylated, ubiquitinated and abnormally cleaved TDP-43.<sup>145,146</sup> TDP-43 is a 43 kDa protein of 414 amino acids encoded by the *TARDBP* gene. *TARDBP* mutations are the most frequent cause of FALS after *SOD1*, with a frequency of ~7%.<sup>147</sup>

In SALS, *TARDBP* mutations occur less frequent, accounting for 0.5-2% of the cases.<sup>147-150</sup> To date more than thirty mutations in *TARDBP* have been reported in ALS patients, and all mutations, except for one, have been found in exon six.<sup>145;147;148;150-160</sup>

TDP-43 is intrinsically aggregation-prone, and several ALS-linked *TARDBP* mutations within the C-terminal domain increase the number of TDP-43 aggregates and promote toxicity *in vivo*.<sup>161-163</sup> Furthermore, TDP-43 appears to be recruited to cytoplasmic aggregates of TDP-43 fragments and causes redistribution to the cytoplasm and possibly a loss-of-function, eventually leading to ALS and other neurodegenerative diseases.<sup>164;165</sup> TDP-43 inclusions and mutations have also been identified in patients with frontotemporal dementia (FTD).<sup>146;150;151;153</sup> Additionally, TDP-43 inclusions have been observed in Parkinson's disease (PD), Alzheimer's disease (AD), Lewy Body Dementia, Huntington, Parkinsonism-Dementia complex and ALS of Guam, and familial British dementia.<sup>166-174</sup>

TDP-43 is a hnRNP that contains four regions: a N-terminal sequence with a NLS, two RRM (RRM1 and 2), containing a nuclear export signal (NES), and a Glycine-rich C-terminal that can mediate protein-protein interactions.<sup>175;176</sup> TDP-43 has been shown to promote skipping of exon nine within the Cystic Fibrosis Transmembrane conductance Regulator (*CFTR*) gene as well as to interact with hnRNP family proteins, which are implicated in splicing inhibition.<sup>177;178</sup> Recently, residues 321 to 366 of the TDP-43 C-terminal region were identified as the binding domain for hnRNP A2 and are also required for the splicing inhibitory activity of TDP-43.<sup>179</sup> In general, hnRNPs are known as transcriptional activators and repressors and are involved in telomere length maintenance, mRNA translation and splicing.<sup>180</sup>

Although TDP-43 is predominantly located in the nucleus, TDP-43 continuously shuttles between the nucleus and cytoplasm, and might even play a role in the regulation of mRNAs transport and local translation in dendrites upon neuronal stimuli.<sup>181</sup> This hypothesis is supported by the presence of DNA- and RNA-binding motifs, a strong nuclear export sequence,<sup>182</sup> and an association with  $\beta$ -actin mRNA and CaM-KIIa mRNA.<sup>183</sup> Furthermore, TDP-43 has been localized in the processing body or P-body,<sup>183</sup> cytosolic substructures, which contain components involved in mRNA degradation, storage and microRNA-mediated repression of translation.<sup>184;185</sup> Interestingly, inhibition of RNA polymerase II with actinomycin D causes TDP-43 to accumulate in the cytoplasm, suggesting that continuous mRNA synthesis is required to signal TDP-43 import.<sup>186</sup>

As mentioned above, TDP-43 is also involved in SMA. Overexpression of TDP-43 promotes inclusion of exon seven during splicing of human SMN2 pre-mRNA.<sup>113</sup> Moreover, TDP-43



has been identified as a factor capable of stimulating a two-fold increase of the relative level of SMN2-derived full-length SMN mRNA, suggesting TDP-43 plays a dual role in alternative splicing, promoting both exon in- and exclusion.<sup>113</sup>

TDP-43 is also able to bind to and stabilize neurofilament (NFL) mRNA.<sup>182;187</sup> The interaction between TDP-43 and NFL mRNA 3'-untranslated region (UTR) involves the RRM1 and RRM2 of TDP-43.<sup>182;187</sup> In an analogous manner, mutant SOD1 has been shown to also bind to the NFL mRNA 3'-UTR and destabilize the transcript.<sup>188</sup> NFL aggregates are frequently observed in ALS patients and since both TDP-43 and NFL have been detected in stress- and degradation granules,<sup>187;189</sup> TDP-43 might be responsible for translational silencing and/or degradation of NFL. Interestingly, p190 Rho guanine nuclear exchange factor (p190RhoGEF) was previously identified as a NFL mRNA stability regulator in mice, and shown to enhanced binding with a 43-kDa protein in brain extracts.<sup>190</sup> Aggregation of p190RhoGEF appears to trigger neurotoxicity<sup>191</sup> and mutations lead to disruption of axonal arborization.<sup>192</sup> Moreover, the human homologue of p190RhoGEF, RGNEF, was shown to interact with NFL mRNA in ALS-derived lysates but not within control lysates.<sup>193</sup> Thus, this data suggests that NFL and TDP-43 are likely to be involved in the pathogenesis. Similar degradation mechanisms might also be implicated in sequestration of other proteins in motor neurons of ALS patients. For instance, it has already been shown that mutant SOD1 is able to bind the VEGF mRNA 3'-UTR, causing post-transcriptional dysregulation of VEGF mRNA.<sup>194;195</sup>

## Additional evidence

Apart from the six genes discussed, there is additional support for a role of RNA processing in ALS. One example comes from peripherin (PRPH), a type II neuronal intermediate filament. Currently, only two mutations have been described in SALS: a 228delC frame shift mutation predicting a truncated PRPH species of 85 amino acids and a homozygous p.D141Y mutation.<sup>196;197</sup> The mutant proteins disrupt assembly of the neurofilament network and are aggregation-prone. Significant elevations of PRPH have been reported in ALS cervical and lumbar spinal cords.<sup>198</sup> Furthermore, overexpression of *PRPH* slows down the axonal transport of neurofilamental proteins, results in intermediate filament (IF) inclusions and causes death of motor neurons.<sup>199-201</sup> Particularly interesting are the three peripherin isoforms generated by alternative splicing in mice: Per 58, Per 56 and Per 61. One of the isoforms, Per 61, is neurotoxic and induces motor neuron degeneration.<sup>202</sup> A novel PRPH transcript that results in a 28 kDa splice isoform has been identified as well.<sup>203</sup> This isoform is normally expressed at low levels, but up-

regulated in ALS patients and is able to induce aggregation. PRPH is known to co-localize with TDP-43 in round inclusions,<sup>204</sup> and since TDP-43 acts as a regulator of alternative splicing, these splicing abnormalities could be related to TDP-43 dysfunction.

In addition, proteins involved in RNA transport (e.g. dynein, dynactin (*DCTN1*) and kinesin-associated protein 3 (*KIFAP3*)) have been shown to have a role in ALS pathogenesis.<sup>205-209</sup> Dynein is the major motor driving retrograde transport, but is also essential for endoplasmic reticulum (ER) to Golgi trafficking, endosome and lysosome motility and spindle assembly.<sup>206</sup> Furthermore, dynein may remove misfolded or degraded proteins from the cell periphery and transport them to the cell body for degradation.<sup>206</sup> Noteworthy is dynein's role as the motor driving the minus end-directed movement of RNA granules along microtubules.<sup>206;207</sup> Many of these mRNAs encode cytoskeletal proteins involved in axon regeneration, including  $\beta$ -actin, tau and neurofilament subunits.<sup>209</sup> Dynein requires the accessory activator complex dynactin for most of these functions possibly acting as an adaptor for dynein, linking the motor to membrane bound vesicles and organelles.<sup>210</sup>

Mutations in dynactin have been detected in patients with neurodegenerative disorders. A p.G59S mutation, which is predicted to distort the folding of dynactin's microtubule-binding domain was present in a family with slowly progressive lower motor neuron disease (MND).<sup>211</sup> Heterozygous missense mutations of the *DCTN1* gene have also been identified in a single SALS case (p.T1249I), an individual with FALS (p.M571T), and two FALS patients along with two unaffected relatives (p.R785W).<sup>212</sup> Lastly, a heterozygous p.R1101K mutation of the p150 subunit of dynactin has been reported in a family with ALS and co-occurrence of FTD.<sup>213</sup> In autopsies from patients with ALS, *DCTN1* is markedly down-regulated in residual motor neurons and appears to be an early sign of degeneration.<sup>214</sup> Overexpression of the p150 subunit of dynactin in cell cultures abolishes the association between aggregation-prone SOD1 mutants and the dynein/dynactin complex, and decreases inclusion formation and improves cell survival.<sup>215</sup> Inhibition of the dynein/dynactin complex leads to focal accumulation of neurofilaments within axonal neurites and causes neurite retraction,<sup>216</sup> stressing the importance of the dynein/dynactin complex in neurons. Mice with neuron-specific expression of Bicaudal D2 N-terminus (*BICD2-N*) to impair dynein/dynactin function do not develop signs of motor neuron degeneration or motor abnormalities.<sup>217</sup> However, mice expressing mutant dynactin p150 demonstrate defects in vesicular transport in cell bodies of motor neurons, axonal swelling and axo-terminal degeneration.<sup>218</sup> Overexpression of dynamitin to disassemble dynactin in mice, causes late-onset progressive motor neuron degeneration with decreased strength and endurance, and denervation of muscles.<sup>219</sup>

A single nucleotide polymorphism (SNP; rs1541160) located within the *KIFAP3* gene was found to associate with survival of SALS in a genome-wide association study (GWAS).<sup>220</sup> Homozygosity for the favorable allele results in a fourteen month survival advantage and correlated with reduced expression of the *KIFAP3* gene. Kinesins are a family of microtubule-binding proteins that act as motors for transport of vesicles, organelles, RNA, and protein complexes.<sup>205;207;208;221-223</sup> *KIFAP3* forms a trimeric kinesin motor complex (KIF<sub>3</sub>) with KIF<sub>3</sub>A and KIF<sub>3</sub>B. The KIF<sub>3</sub>-complex is abundantly expressed in neuronal tissue, and is known to function as motor for anterograde transport of membrane-bound organelles and neurite extension. The role of *KIFAP3* is thought to mediate the binding to cargo. Interestingly, *KIFAP3* has been shown to associate with misfolded SOD1 species and incorporates into SOD1 aggregates of FALS patients.<sup>224</sup> In *SOD1*<sup>G86R</sup> mice, *KIFAP3* is up-regulated during the asymptomatic phase in the lumbar spinal cord, long before axonal degeneration. The *KIFAP3* protein also accumulates in large motor neurons of the ventral spinal cord.<sup>225</sup> Down-regulation of other kinesins has also been detected in SALS.<sup>226</sup>

RNA processing is also implicated with the progranulin gene (*PGRN*). Over fifty mutations in *PGRN* have been identified in patients with FTD who have tau-negative, ubiquitin-positive inclusions.<sup>227-232</sup> *PGRN* is a secreted high molecular weight growth factor, which regulates cell division, survival, migration, early embryogenesis, adult tissue repair and inflammation.<sup>233</sup> The *PGRN* gene is highly expressed by motor neurons within the mouse spinal cord, and located within compartments of the secretory pathway including the Golgi apparatus. It is cytoprotective over prolonged periods when overexpressed in neuronal cell lines.<sup>234</sup> A common genetic variant (rs5848) in the *PGRN* gene is located on the 3'-UTR in a binding site for microRNA (miR-569), which regulates *PGRN* expression *in vitro*. This genetic variant is a major susceptibility factor for FTD in the North American population: homozygous carriers of the T-allele have a 3.2-fold increased risk of developing FTD compared to homozygous C-allele carriers.<sup>235</sup> Although replication in other populations has proven to be challenging, translational regulation by microRNAs could represent a common mechanism involved in neurodegenerative disorders.<sup>236-238</sup> Mutations in *PGRN* have been detected in patients with ALS and ALS-FTD as well,<sup>227;239;240</sup> and common variants were significantly associated with a reduction in age of onset and shortened survival.<sup>240</sup> In spinal cord and brainstem sections of ALS patients, increased staining for *PGRN* in motor tracts with vacuolar degeneration and glial cells has been detected, as well as variable upper motor neuron staining and reactive glia in motor cortex samples.<sup>241</sup> *PGRN* has also been shown to mediate proteolytic cleavage of TDP-43 to generate ~35 and ~25 kDa species, and suppression of *PGRN* expression leads to caspase-dependent accumulation of TDP-43 fragments.<sup>242</sup>

Finally, RNA oxidation may play a role in a variety of neurodegenerative disorders as well. It has been shown that both mRNA and rRNA are damaged in ALS and AD, and many of the oxidized mRNAs are implicated in the pathogenesis of these diseases.<sup>243</sup> In transgenic mice expressing ALS-linked mutant SOD<sub>1</sub>, increased mRNA oxidation predominantly occurs in the motor neurons and oligodendrocytes of the spinal cord at an early, pre-symptomatic stage.<sup>244</sup> Oxidative modifications can influence the translational process and cause reduced protein expression. Therefore, RNA oxidation could be a common factor in the pathogenesis of neurodegenerative disorders.

## Conclusions

The recent identification of two RNA-binding proteins, TDP-43 and FUS/TLS, that, when mutated, cause ALS has led researchers to further evaluate the RNA processing pathway as a common pathogenic pathway. Within this review, we have focused on six RNA processing genes implicated in ALS. The pathway of RNA processing is indeed complex, and understanding how alterations can lead to ALS will be a challenging goal. However, knowing that this pathway is involved in ALS will undoubtedly be beneficial in identifying additional genetic components of ALS.

## References

- (1) Chio A, Mora G, Calvo A, Mazzini L, Bottacchi E, Mutani R. Epidemiology of ALS in Italy: a 10-year prospective population-based study. *Neurology* 2009;72:725-731.
- (2) Fang F, Valdimarsdottir U, Bellocchio R et al. Amyotrophic lateral sclerosis in Sweden, 1991-2005. *Arch Neurol* 2009;66:515-519.
- (3) Turner MR, Kiernan MC, Leigh PN, Talbot K. Biomarkers in amyotrophic lateral sclerosis. *Lancet Neurol* 2009;8:94-109.
- (4) Rosen DR, Siddique T, Patterson D et al. Mutations in Cu/Zn superoxide dismutase gene are associated with familial amyotrophic lateral sclerosis. *Nature* 1993;362:59-62.
- (5) Valdmanis PN, Rouleau GA. Genetics of familial amyotrophic lateral sclerosis. *Neurology* 2008;70:144-152.
- (6) Greenway MJ, Andersen PM, Russ C et al. ANG mutations segregate with familial and 'sporadic' amyotrophic lateral sclerosis. *Nat Genet* 2006;38:411-413.
- (7) Conforti FL, Sprovieri T, Mazzei R et al. A novel Angiogenin gene mutation in a sporadic patient with amyotrophic lateral sclerosis from southern Italy. *Neuromuscul Disord* 2008;18:68-70.

- (8) Fernandez-Santiago R, Hoenig S, Lichtner P et al. Identification of novel Angiogenin (ANG) gene missense variants in German patients with amyotrophic lateral sclerosis. *J Neurol* 2009;256:1337-1342.
- (9) Gellera C, Colombrita C, Ticozzi N et al. Identification of new ANG gene mutations in a large cohort of Italian patients with amyotrophic lateral sclerosis. *Neurogenetics* 2008;9:33-40.
- (10) Paubel A, Violette J, Amy M et al. Mutations of the ANG gene in French patients with sporadic amyotrophic lateral sclerosis. *Arch Neurol* 2008;65:1333-1336.
- (11) van Es MA, Diekstra FP, Veldink JH et al. A case of ALS-FTD in a large FALS pedigree with a K17I ANG mutation. *Neurology* 2009;72:287-288.
- (12) Wu D, Yu W, Kishikawa H et al. Angiogenin loss-of-function mutations in amyotrophic lateral sclerosis. *Ann Neurol* 2007;62:609-617.
- (13) Kishimoto K, Liu S, Tsuji T, Olson KA, Hu GF. Endogenous angiogenin in endothelial cells is a general requirement for cell proliferation and angiogenesis. *Oncogene* 2005;24:445-456.
- (14) Kulka M, Fukuishi N, Metcalfe DD. Human mast cells synthesize and release angiogenin, a member of the ribonuclease A (RNase A) superfamily. *J Leukoc Biol* 2009;86:1217-1226.
- (15) Moenner M, Gusse M, Hatzi E, Badet J. The widespread expression of angiogenin in different human cells suggests a biological function not only related to angiogenesis. *Eur J Biochem* 1994;226:483-490.
- (16) Huang L, Huang Y, Guo H. Dominant expression of angiogenin in NeuN positive cells in the focal ischemic rat brain. *J Neurol Sci* 2009;285:220-223.
- (17) Moroianu J, Riordan JF. Identification of the nucleolar targeting signal of human angiogenin. *Biochem Biophys Res Commun* 1994;203:1765-1772.
- (18) Moroianu J, Riordan JF. Nuclear translocation of angiogenin in proliferating endothelial cells is essential to its angiogenic activity. *Proc Natl Acad Sci USA* 1994;91:1677-1681.
- (19) Shapiro R. Structural features that determine the enzymatic potency and specificity of human angiogenin: threonine-80 and residues 58-70 and 116-123. *Biochemistry* 1998;37:6847-6856.
- (20) Kieran D, Sebastia J, Greenway MJ et al. Control of motoneuron survival by angiogenin. *J Neurosci* 2008;28:14056-14061.
- (21) Sebastia J, Kieran D, Breen B et al. Angiogenin protects motoneurons against hypoxic injury. *Cell Death Differ* 2009;16:1238-1347.
- (22) Cronin S, Greenway MJ, Ennis S et al. Elevated serum angiogenin levels in ALS. *Neurology* 2006;67:1833-1836.
- (23) Moreau C, Gosset P, Brunaud-Danel V et al. CSF profiles of angiogenic and inflammatory factors depend on the respiratory status of ALS patients. *Amyotroph Lateral Scler* 2009;10:175-181.

- (24) Subramanian V, Crabtree B, Acharya KR. Human angiogenin is a neuroprotective factor and amyotrophic lateral sclerosis associated angiogenin variants affect neurite extension/pathfinding and survival of motor neurons. *Hum Mol Genet* 2008;17:130-149.
- (25) Subramanian V, Feng Y. A new role for angiogenin in neurite growth and pathfinding: implications for amyotrophic lateral sclerosis. *Hum Mol Genet* 2007;16:1445-1453.
- (26) Campo L, Turley H, Han C et al. Angiogenin is up-regulated in the nucleus and cytoplasm in human primary breast carcinoma and is associated with markers of hypoxia but not survival. *J Pathol* 2005;205:585-591.
- (27) Chopra V, Dinh TV, Hannigan EV. Angiogenin, interleukins, and growth-factor levels in serum of patients with ovarian cancer: correlation with angiogenesis. *Cancer J Sci Am* 1996;2:279-285.
- (28) Chopra V, Dinh TV, Hannigan EV. Circulating serum levels of cytokines and angiogenic factors in patients with cervical cancer. *Cancer Invest* 1998;16:152-159.
- (29) Chopra V, Dinh TV, Hannigan EV. Serum levels of interleukins, growth factors and angiogenin in patients with endometrial cancer. *J Cancer Res Clin Oncol* 1997;123:167-172.
- (30) Shimoyama S, Gansauge F, Gansauge S, Negri G, Oohara T, Beger HG. Increased angiogenin expression in pancreatic cancer is related to cancer aggressiveness. *Cancer Res* 1996;56:2703-2706.
- (31) Shimoyama S, Kaminishi M. Increased angiogenin expression in gastric cancer correlated with cancer progression. *J Cancer Res Clin Oncol* 2000;126:468-474.
- (32) Shimoyama S, Yamasaki K, Kawahara M, Kaminishi M. Increased serum angiogenin concentration in colorectal cancer is correlated with cancer progression. *Clin Cancer Res* 1999;5:1125-1130.
- (33) Vihinen P, Kallioinen M, Vuoristo MS et al. Serum angiogenin levels predict treatment response in patients with stage IV melanoma. *Clin Exp Metastasis* 2007;24:567-574.
- (34) Zhao H, Grossman HB, Delclos GL et al. Increased plasma levels of angiogenin and the risk of bladder carcinoma: from initiation to recurrence. *Cancer* 2005;104:30-35.
- (35) Chiarelli F, Pomilio M, Mohn A et al. Serum angiogenin concentrations in young patients with diabetes mellitus. *Eur J Clin Invest* 2002;32:110-114.
- (36) Malamitsi-Puchner A, Sarandakou A, Dafogianni C, Tziotis J, Bartsocas CS. Serum angiogenin levels in children and adolescents with insulin-dependent diabetes mellitus. *Pediatr Res* 1998;43:798-800.
- (37) Siebert J, Reiwer-Gostomska M, Babinska Z et al. Low serum angiogenin concentrations in patients with type 2 diabetes. *Diabetes Care* 2007;30:3086-3087.
- (38) Kristan SS, Malovrh MM, Silar M et al. Airway angiogenesis in patients with rhinitis and controlled asthma. *Clin Exp Allergy* 2009;39:354-360.
- (39) Simcock DE, Kanabar V, Clarke GW, O'Connor BJ, Lee TH, Hirst SJ. Proangiogenic activity in bronchoalveolar lavage fluid from patients with asthma. *Am J Respir Crit Care Med* 2007;176:146-153.

- (40) Patel JV, Sosin M, Gunarathne A et al. Elevated angiogenin levels in chronic heart failure. *Ann Med* 2008;40:474-479.
- (41) Kim SH, Choi YM, Chae HD, Kim CH, Kang BM. Decreased expression of angiogenin in the eutopic endometrium from women with advanced stage endometriosis. *J Korean Med Sci* 2008;23:802-807.
- (42) Steff AM, Gagne D, Page M, Rioux A, Hugo P, Gosselin D. Serum concentrations of insulin-like growth factor-1, soluble tumor necrosis factor receptor-1 and angiogenin in endometriosis patients. *Am J Reprod Immunol* 2004;51:166-173.
- (43) Suzumori N, Zhao XX, Suzumori K. Elevated angiogenin levels in the peritoneal fluid of women with endometriosis correlate with the extent of the disorder. *Fertil Steril* 2004;82:93-96.
- (44) Saxena SK, Rybak SM, Davey RT Jr, Youle RJ, Ackerman EJ. Angiogenin is a cytotoxic, tRNA-specific ribonuclease in the RNase A superfamily. *J Biol Chem* 1992;267:21982-21986.
- (45) Fu H, Feng J, Liu Q et al. Stress induces tRNA cleavage by angiogenin in mammalian cells. *FEBS Lett* 2009;583:437-442.
- (46) Yamasaki S, Ivanov P, Hu GF, Anderson P. Angiogenin cleaves tRNA and promotes stress-induced translational repression. *J Cell Biol* 2009;185:35-42.
- (47) Xu ZP, Tsuji T, Riordan JF, Hu GF. Identification and characterization of an angiogenin-binding DNA sequence that stimulates luciferase reporter gene expression. *Biochemistry* 2003;42:121-128.
- (48) Xu ZP, Tsuji T, Riordan JF, Hu GF. The nuclear function of angiogenin in endothelial cells is related to rRNA production. *Biochem Biophys Res Commun* 2002;294:287-292.
- (49) Tsuji T, Sun Y, Kishimoto K et al. Angiogenin is translocated to the nucleus of HeLa cells and is involved in ribosomal RNA transcription and cell proliferation. *Cancer Res* 2005;65:1352-1360.
- (50) Simpson CL, Lemmens R, Miskiewicz K et al. Variants of the elongator protein 3 (ELP3) gene are associated with motor neuron degeneration. *Hum Mol Genet* 2009;18:472-481.
- (51) Creppe C, Malinouskaya L, Volvert ML et al. Elongator controls the migration and differentiation of cortical neurons through acetylation of alpha-tubulin. *Cell* 2009;136:551-564.
- (52) Falcioni T, Papa S, Campana R et al. Flow cytometric evaluation of *Vibrio parahaemolyticus* adhesion inhibition to human epithelial cells. *Cytometry B Clin Cytom* 2005;66:25-35.
- (53) Winkler GS, Petrakis TG, Ethelberg S et al. RNA polymerase II elongator holoenzyme is composed of two discrete subcomplexes. *J Biol Chem* 2001;276:32743-32749.
- (54) Winkler GS, Kristjuhan A, Erdjument-Bromage H, Tempst P, Svejstrup JQ. Elongator is a histone H3 and H4 acetyltransferase important for normal histone acetylation levels in vivo. *Proc Natl Acad Sci USA* 2002;99:3517-3522.
- (55) Huang B, Johansson MJ, Bystrom AS. An early step in wobble uridine tRNA modification requires the Elongator complex. *RNA* 2005;11:424-436.

- (56) Anderson SL, Coli R, Daly IW et al. Familial dysautonomia is caused by mutations of the IKAP gene. *Am J Hum Genet* 2001;68:753-758.
- (57) Greenwood C, Selth LA, Dirac-Svejstrup AB, Svejstrup JQ. An iron-sulfur cluster domain in Elp3 important for the structural integrity of elongator. *J Biol Chem* 2009;284:141-149.
- (58) Kristjuhan A, Svejstrup JQ. Evidence for distinct mechanisms facilitating transcript elongation through chromatin in vivo. *EMBO J* 2004;23:4243-4252.
- (59) Zhang Z, Lotti F, Dittmar K et al. SMN deficiency causes tissue-specific perturbations in the repertoire of snRNAs and widespread defects in splicing. *Cell* 2008;133:585-600.
- (60) Han Q, Lu J, Duan J et al. Gcn5- and Elp3-induced histone H3 acetylation regulates hsp70 gene transcription in yeast. *Biochem J* 2008;409:779-788.
- (61) Kwiatkowski TJ Jr, Bosco DA, Leclerc AL et al. Mutations in the FUS/TLS gene on chromosome 16 cause familial amyotrophic lateral sclerosis. *Science* 2009;323:1205-1208.
- (62) Vance C, Rogelj B, Hortobagyi T et al. Mutations in FUS, an RNA processing protein, cause familial amyotrophic lateral sclerosis type 6. *Science* 2009;323:1208-1211.
- (63) Ruddy DM, Parton MJ, Al-Chalabi A et al. Two families with familial amyotrophic lateral sclerosis are linked to a novel locus on chromosome 16q. *Am J Hum Genet* 2003;73:390-396.
- (64) Belzil VV, Valdmanis PN, Dion PA et al. Mutations in FUS cause FALS and SALS in French and French Canadian populations. *Neurology* 2009;73:1176-1179.
- (65) Chio A, Restagno G, Brunetti M et al. Two Italian kindreds with familial amyotrophic lateral sclerosis due to FUS mutation. *Neurobiol Aging* 2009;30:1272-1275.
- (66) Drepper C, Herrmann T, Wessig C, Beck M, Sendtner M. C-terminal FUS/TLS mutations in familial and sporadic ALS in Germany. *Neurobiol Aging* 2011;32:548.e1-e4.
- (67) Groen EJ, van Es MA, van Vught PW. FUS mutations in familial amyotrophic lateral sclerosis in the Netherlands. *Arch Neurol* 2010;67:224-230.
- (68) Tateishi T, Hokonohara T, Yamasaki R et al. Multiple system degeneration with basophilic inclusions in Japanese ALS patients with FUS mutation. *Acta Neuropathol* 2010;119:355-364.
- (69) Ticozzi N, Silani V, Leclerc AL et al. Analysis of FUS gene mutation in familial amyotrophic lateral sclerosis within an Italian cohort. *Neurology* 2009;73:1180-1185.
- (70) Iko Y, Kodama TS, Kasai N et al. Domain architectures and characterization of an RNA-binding protein, TLS. *J Biol Chem* 2004;279:44834-44840.
- (71) Lerga A, Hallier M, Delva L et al. Identification of an RNA binding specificity for the potential splicing factor TLS. *J Biol Chem* 2001;276:6807-6816.
- (72) Zinszner H, Sok J, Immanuel D, Yin Y, Ron D. TLS (FUS) binds RNA in vivo and engages in nucleocytoplasmic shuttling. *J Cell Sci* 1997;110 ( Pt 15):1741-1750.



- (73) Rabbitts TH, Forster A, Larson R, Nathan P. Fusion of the dominant negative transcription regulator CHOP with a novel gene FUS by translocation t(12;16) in malignant liposarcoma. *Nat Genet* 1993;4:175-180.
- (74) Perez-Losada J, Sanchez-Martin M, Rodriguez-Garcia MA et al. Liposarcoma initiated by FUS/TLS-CHOP: the FUS/TLS domain plays a critical role in the pathogenesis of liposarcoma. *Oncogene* 2000;19:6015-6022.
- (75) Calvio C, Neubauer G, Mann M, Lamond AI. Identification of hnRNP P2 as TLS/FUS using electrospray mass spectrometry. *RNA* 1995;1:724-733.
- (76) Bertolotti A, Lutz Y, Heard DJ, Chambon P, Tora L. hTAF(II)68, a novel RNA/ssDNA-binding protein with homology to the pro-oncoproteins TLS/FUS and EWS is associated with both TFIID and RNA polymerase II. *EMBO J* 1996;15:5022-5031.
- (77) Zinzner H, Albalat R, Ron D. A novel effector domain from the RNA-binding protein TLS or EWS is required for oncogenic transformation by CHOP. *Genes Dev* 1994;8:2513-2526.
- (78) Belly A, Moreau-Gachelin F, Sadoul R, Goldberg Y. Delocalization of the multifunctional RNA splicing factor TLS/FUS in hippocampal neurones: exclusion from the nucleus and accumulation in dendritic granules and spine heads. *Neurosci Lett* 2005;379:152-157.
- (79) Selamat W, Jamari I, Wang Y, Takumi T, Wong F, Fujii R. TLS interaction with NMDA R1 splice variant in retinal ganglion cell line RGC-5. *Neurosci Lett* 2009;450:163-166.
- (80) Yoshimura A, Fujii R, Watanabe Y, Okabe S, Fukui K, Takumi T. Myosin-Va facilitates the accumulation of mRNA/protein complex in dendritic spines. *Curr Biol* 2006;16:2345-2351.
- (81) Delva L, Gallais I, Guillouf C, Denis N, Orvain C, Moreau-Gachelin F. Multiple functional domains of the oncoproteins Spi-1/PU.1 and TLS are involved in their opposite splicing effects in erythroleukemic cells. *Oncogene* 2004;23:4389-4399.
- (82) Goransson M, Andersson MK, Forni C et al. The myxoid liposarcoma FUS-DDIT3 fusion oncoprotein deregulates NF-kappaB target genes by interaction with NFKBIZ. *Oncogene* 2009;28:270-278.
- (83) Uranishi H, Tetsuka T, Yamashita M et al. Involvement of the pro-oncoprotein TLS (translocated in liposarcoma) in nuclear factor-kappa B p65-mediated transcription as a coactivator. *J Biol Chem* 2001;276:13395-13401.
- (84) Wang X, Arai S, Song X et al. Induced ncRNAs allosterically modify RNA-binding proteins in cis to inhibit transcription. *Nature* 2008;454:126-130.
- (85) Meissner M, Lopato S, Gotzmann J, Sauermann G, Barta A. Proto-oncoprotein TLS/FUS is associated to the nuclear matrix and complexed with splicing factors PTB, SRm160, and SR proteins. *Exp Cell Res* 2003;283:184-195.
- (86) Yang L, Embree LJ, Tsai S, Hickstein DD. Oncoprotein TLS interacts with serine-arginine proteins involved in RNA splicing. *J Biol Chem* 1998;273:27761-27764.

- (87) Andersson MK, Stahlberg A, Arvidsson Y et al. The multifunctional FUS, EWS and TAF<sub>15</sub> oncoproteins show cell type-specific expression patterns and involvement in cell spreading and stress response. *BMC Cell Biol* 2008;9:37.
- (88) Law WJ, Cann KL, Hicks GG. TLS, EWS and TAF<sub>15</sub>: a model for transcriptional integration of gene expression. *Brief Funct Genomic Proteomic* 2006;5:8-14.
- (89) Chen YZ, Bennett CL, Huynh HM et al. DNA/RNA helicase gene mutations in a form of juvenile amyotrophic lateral sclerosis (ALS<sub>4</sub>). *Am J Hum Genet* 2004;74:1128-1135.
- (90) Zhao ZH, Chen WZ, Wu ZY et al. A novel mutation in the senataxin gene identified in a Chinese patient with sporadic amyotrophic lateral sclerosis. *Amyotroph Lateral Scler* 2009;10:118-122.
- (91) Moreira MC, Klur S, Watanabe M et al. Senataxin, the ortholog of a yeast RNA helicase, is mutant in ataxia-ocular apraxia 2. *Nat Genet* 2004;36:225-227.
- (92) Anheim M, Fleury MC, Franques J et al. Clinical and molecular findings of ataxia with oculomotor apraxia type 2 in 4 families. *Arch Neurol* 2008;65:958-962.
- (93) Anheim M, Monga B, Fleury M et al. Ataxia with oculomotor apraxia type 2: clinical, biological and genotype/phenotype correlation study of a cohort of 90 patients. *Brain* 2009;132:2688-2698.
- (94) Arning L, Schols L, Cin H, Souquet M, Epplen JT, Timmann D. Identification and characterisation of a large senataxin (SETX) gene duplication in ataxia with ocular apraxia type 2 (AOA2). *Neurogenetics* 2008;9:295-299.
- (95) Criscuolo C, Chessa L, Di Giandomenico S et al. Ataxia with oculomotor apraxia type 2: a clinical, pathologic, and genetic study. *Neurology* 2006;66:1207-1210.
- (96) Fogel BL, Perlman S. Novel mutations in the senataxin DNA/RNA helicase domain in ataxia with oculomotor apraxia 2. *Neurology* 2006;67:2083-2084.
- (97) Schols L, Arning L, Schule R, Epplen JT, Timmann D. "Pseudodominant inheritance" of ataxia with ocular apraxia type 2 (AOA2). *J Neurol* 2008;255:495-501.
- (98) Tazir M, Ali-Pacha L, M'Zahem A et al. Ataxia with oculomotor apraxia type 2: a clinical and genetic study of 19 patients. *J Neurol Sci* 2009;278:77-81.
- (99) Chen YZ, Hashemi SH, Anderson SK et al. Senataxin, the yeast Sen1p orthologue: characterization of a unique protein in which recessive mutations cause ataxia and dominant mutations cause motor neuron disease. *Neurobiol Dis* 2006;23:97-108.
- (100) Hickson ID. RecQ helicases: caretakers of the genome. *Nat Rev Cancer* 2003;3:169-178.
- (101) Tanner NK, Linder P. DExD/H box RNA helicases: from generic motors to specific dissociation functions. *Mol Cell* 2001;8:251-262.
- (102) Mendell JT, ap Rhys CM, Dietz HC. Separable roles for rent1/hUpf1 in altered splicing and decay of nonsense transcripts. *Science* 2002;298:419-422.

- (103) Banihashemi L, Wilson GM, Das N, Brewer G. Upf1/Upf2 regulation of 3' untranslated region splice variants of AUF1 links nonsense-mediated and A+U-rich element-mediated mRNA decay. *Mol Cell Biol* 2006;26:8743-8754.
- (104) Guenther UP, Handoko L, Laggerbauer B et al. IGHBMP2 is a ribosome-associated helicase inactive in the neuromuscular disorder distal SMA type 1 (DSMA1). *Hum Mol Genet* 2009;18:1288-1300.
- (105) de Planell-Saguer M, Schroeder DG, Rodicio MC, Cox GA, Mourelatos Z. Biochemical and genetic evidence for a role of IGHBMP2 in the translational machinery. *Hum Mol Genet* 2009;18:2115-2126.
- (106) Grohmann K, Schuelke M, Diers A et al. Mutations in the gene encoding immunoglobulin mu-binding protein 2 cause spinal muscular atrophy with respiratory distress type 1. *Nat Genet* 2001;29:75-77.
- (107) Ursic D, Chinchilla K, Finkel JS, Culbertson MR. Multiple protein/protein and protein/RNA interactions suggest roles for yeast DNA/RNA helicase Sen1p in transcription, transcription-coupled DNA repair and RNA processing. *Nucleic Acids Res* 2004;32:2441-2452.
- (108) Steinmetz EJ, Warren CL, Kuehner JN, Panbehi B, Ansari AZ, Brow DA. Genome-wide distribution of yeast RNA polymerase II and its control by Sen1 helicase. *Mol Cell* 2006;24:735-746.
- (109) Suraweera A, Becherel OJ, Chen P et al. Senataxin, defective in ataxia oculomotor apraxia type 2, is involved in the defense against oxidative DNA damage. *J Cell Biol* 2007;177:969-979.
- (110) Lefebvre S, Bürglen L, Reboullet S et al. Identification and characterization of a spinal muscular atrophy-determining gene. *Cell* 1995;80:155-165.
- (111) Lorson CL, Hahnen E, Androphy EJ, Wirth B. A single nucleotide in the SMN gene regulates splicing and is responsible for spinal muscular atrophy. *Proc Natl Acad Sci U S A* 1999;96:6307-6311.
- (112) Monani UR, Lorson CL, Parsons DW et al. A single nucleotide difference that alters splicing patterns distinguishes the SMA gene SMN1 from the copy gene SMN2. *Hum Mol Genet* 1999;8:1177-1183.
- (113) Bose JK, Wang IF, Hung L, Tarn WY, Shen CK. TDP-43 overexpression enhances exon 7 inclusion during the survival of motor neuron pre-mRNA splicing. *J Biol Chem* 2008;283:28852-28859.
- (114) Chen HH, Chang JG, Lu RM, Peng TY, Tarn WY. The RNA binding protein hnRNP Q modulates the utilization of exon 7 in the survival motor neuron 2 (SMN2) gene. *Mol Cell Biol* 2008;28:6929-6938.
- (115) Kashima T, Rao N, David CJ, Manley JL. hnRNP A1 functions with specificity in repression of SMN2 exon 7 splicing. *Hum Mol Genet* 2007;16:3149-3159.
- (116) Barnes JW, Brown RH, Turtle EP et al. A 5-micron-bright spot on Titan: evidence for surface diversity. *Science* 2005;310:92-95.
- (117) Gennarelli M, Lucarelli M, Capon F et al. Survival motor neuron gene transcript analysis in muscles from spinal muscular atrophy patients. *Biochem Biophys Res Commun* 1995;213:342-348.
- (118) Lorson CL, Strasswimmer J, Yao JM et al. SMN oligomerization defect correlates with spinal muscular atrophy severity. *Nat Genet* 1998;19:63-66.

- (119) Martins de Araujo M, Bonnal S, Hastings ML, Krainer AR, Valcarcel J. Differential 3' splice site recognition of SMN1 and SMN2 transcripts by U2AF and U2 snRNP. *RNA* 2009;15:515-523.
- (120) Coover DD, Le TT, McAndrew PE et al. The survival motor neuron protein in spinal muscular atrophy. *Hum Mol Genet* 1997;6:1205-1214.
- (121) Corcia P, Camu W, Halimi JM et al. SMN1 gene, but not SMN2, is a risk factor for sporadic ALS. *Neurology* 2006;67:1147-1150.
- (122) Corcia P, Mayeux-Portas V, Khoris J et al. Abnormal SMN1 gene copy number is a susceptibility factor for amyotrophic lateral sclerosis. *Ann Neurol* 2002;51:243-246.
- (123) Veldink JH, Kalmijn S, Van der Hout A. H et al. SMN genotypes producing less SMN protein increase susceptibility to and severity of sporadic ALS. *Neurology* 2005;65:820-825.
- (124) Veldink JH, van den Berg LH, Cobben JM et al. Homozygous deletion of the survival motor neuron 2 gene is a prognostic factor in sporadic ALS. *Neurology* 2001;56:749-752.
- (125) Liu Q, Dreyfuss G. A novel nuclear structure containing the survival of motor neurons protein. *EMBO J* 1996;15:3555-3565.
- (126) Ogg SC, Lamond AI. Cajal bodies and coilin--moving towards function. *J Cell Biol* 2002;159:17-21.
- (127) Battle DJ, Kasim M, Wang J, Dreyfuss G. SMN-independent subunits of the SMN complex. Identification of a small nuclear ribonucleoprotein assembly intermediate. *J Biol Chem* 2007;282:27953-27959.
- (128) Gubitza AK, Feng W, Dreyfuss G. The SMN complex. *Exp Cell Res* 2004;296:51-56.
- (129) Chari A, Golas MM, Klingenhager M et al. An assembly chaperone collaborates with the SMN complex to generate spliceosomal SnRNPs. *Cell* 2008;135:497-509.
- (130) Battle DJ, Kasim M, Yong J et al. The SMN complex: an assembly machine for RNPs. *Cold Spring Harb Symp Quant Biol* 2006;71:313-320.
- (131) Zou T, Ilangovan R, Yu F, Xu Z, Zhou J. SMN protects cells against mutant SOD1 toxicity by increasing chaperone activity. *Biochem Biophys Res Commun* 2007;364:850-855.
- (132) Carnegie GK, Sleeman JE, Morrice N et al. Protein phosphatase 4 interacts with the Survival of Motor Neurons complex and enhances the temporal localisation of snRNPs. *J Cell Sci* 2003;116:1905-1913.
- (133) Petri S, Grimmler M, Over S, Fischer U, Gruss OJ. Dephosphorylation of survival motor neurons (SMN) by PPM1G/PP2Cgamma governs Cajal body localization and stability of the SMN complex. *J Cell Biol* 2007;179:451-465.
- (134) Hebert MD, Szymczyk PW, Shpargel KB, Matera AG. Coilin forms the bridge between Cajal bodies and SMN, the spinal muscular atrophy protein. *Genes Dev* 2001;15:2720-2729.
- (135) Lefebvre S, Burlet P, Viollet L et al. A novel association of the SMN protein with two major non-ribosomal nucleolar proteins and its implication in spinal muscular atrophy. *Hum Mol Genet* 2002;11:1017-1027.

- (136) Pellizzoni L, Baccon J, Charroux B, Dreyfuss G. The survival of motor neurons (SMN) protein interacts with the snoRNP proteins fibrillarin and GAR1. *Curr Biol* 2001;11:1079-1088.
- (137) Rossoll W, Kroning AK, Ohndorf UM, Steegborn C, Jablonka S, Sendtner M. Specific interaction of Smn, the spinal muscular atrophy determining gene product, with hnRNP-R and gry-rbp/hnRNP-Q: a role for Smn in RNA processing in motor axons? *Hum Mol Genet* 2002;11:93-105.
- (138) Tadesse H, Deschenes-Furry J, Boisvenue S, Cote J. KH-type splicing regulatory protein interacts with survival motor neuron protein and is misregulated in spinal muscular atrophy. *Hum Mol Genet* 2008;17:506-524.
- (139) Kariya S, Park GH, Maeno-Hikichi Y et al. Reduced SMN protein impairs maturation of the neuromuscular junctions in mouse models of spinal muscular atrophy. *Hum Mol Genet* 2008;17:2552-2569.
- (140) Murray LM, Comley LH, Thomson D, Parkinson N, Talbot K, Gillingwater TH. Selective vulnerability of motor neurons and dissociation of pre- and post-synaptic pathology at the neuromuscular junction in mouse models of spinal muscular atrophy. *Hum Mol Genet* 2008;17:949-962.
- (141) McGovern VL, Gavrilina TO, Beattie CE, Burghes AH. Embryonic motor axon development in the severe SMA mouse. *Hum Mol Genet* 2008;17:2900-2909.
- (142) Gabanella F, Butchbach ME, Saieva L, Carissimi C, Burghes AH, Pellizzoni L. Ribonucleoprotein assembly defects correlate with spinal muscular atrophy severity and preferentially affect a subset of spliceosomal snRNPs. *PLoS One* 2007;2:e921.
- (143) Brichta L, Garbes L, Jedrzejowska M et al. Nonsense-mediated messenger RNA decay of survival motor neuron 1 causes spinal muscular atrophy. *Hum Genet* 2008;123:141-153.
- (144) Turner BJ, Parkinson NJ, Davies KE, Talbot K. Survival motor neuron deficiency enhances progression in an amyotrophic lateral sclerosis mouse model. *Neurobiol Dis* 2009;34:511-517.
- (145) Kuhnlein P, Sperfeld AD, Vanmassenhove B et al. Two German kindreds with familial amyotrophic lateral sclerosis due to TARDBP mutations. *Arch Neurol* 2008;65:1185-1189.
- (146) Neumann M, Sampathu DM, Kwong LK et al. Ubiquitinated TDP-43 in frontotemporal lobar degeneration and amyotrophic lateral sclerosis. *Science* 2006;314:130-133.
- (147) Corrado L, Ratti A, Gellera C et al. High frequency of TARDBP gene mutations in Italian patients with amyotrophic lateral sclerosis. *Hum Mutat* 2009;30:688-694.
- (148) Daoud H, Valdmanis PN, Kabashi E et al. Contribution of TARDBP mutations to sporadic amyotrophic lateral sclerosis. *J Med Genet* 2009;46:112-114.
- (149) Ticozzi N, Leclerc AL, van Blitterswijk M et al. Mutational analysis of TARDBP in neurodegenerative diseases. *Neurobiol Aging* 2011;32:2096-2099.
- (150) Van Deerlin VM, Leverenz JB, Bekris LM et al. TARDBP mutations in amyotrophic lateral sclerosis with TDP-43 neuropathology: a genetic and histopathological analysis. *Lancet Neurol* 2008;7:409-416.

- (151) Benajiba L, Le Ber I, Camuzat A et al. TARDBP mutations in motoneuron disease with frontotemporal lobar degeneration. *Ann Neurol* 2009;65:470-473.
- (152) Del Bo R, Ghezzi S, Corti S et al. TARDBP (TDP-43) sequence analysis in patients with familial and sporadic ALS: identification of two novel mutations. *Eur J Neurol* 2009;16:727-732.
- (153) Gitcho MA, Baloh RH, Chakraverty S et al. TDP-43 A315T mutation in familial motor neuron disease. *Ann Neurol* 2008;63:535-538.
- (154) Kabashi E, Valdmanis PN, Dion P et al. TARDBP mutations in individuals with sporadic and familial amyotrophic lateral sclerosis. *Nat Genet* 2008;40:572-574.
- (155) Kamada M, Maruyama H, Tanaka E et al. Screening for TARDBP mutations in Japanese familial amyotrophic lateral sclerosis. *J Neurol Sci* 2009;284:69-71.
- (156) Kirby J, Goodall EF, Smith W et al. Broad clinical phenotypes associated with TAR-DNA binding protein (TARDBP) mutations in amyotrophic lateral sclerosis. *Neurogenetics* 2010;11:217-225.
- (157) Origone P, Caponnetto C, Bandettini di Poggio M et al. Enlarging clinical spectrum of FALS with TARDBP gene mutations: S393L variant in an Italian family showing phenotypic variability and relevance for genetic counselling. *Amyotroph Lateral Scler* 2009;27:1-5.
- (158) Rutherford NJ, Zhang YJ, Baker M et al. Novel mutations in TARDBP (TDP-43) in patients with familial amyotrophic lateral sclerosis. *PLoS Genet* 2008;4:e1000193.
- (159) Sreedharan J, Blair IP, Tripathi VB et al. TDP-43 mutations in familial and sporadic amyotrophic lateral sclerosis. *Science* 2008;319:1668-1672.
- (160) Xiong H L, Wang JY, Sun Y M et al. Association between novel TARDBP mutations and Chinese patients with amyotrophic lateral sclerosis. *BMC Med Genet* 2010;11:8.
- (161) Arai T, Hasegawa M, Nonaka T et al. Phosphorylated and cleaved TDP-43 in ALS, FTLD and other neurodegenerative disorders and in cellular models of TDP-43 proteinopathy. *Neuropathology* 2010;30:170-181.
- (162) Johnson BS, Snead D, Lee JJ, McCaffery JM, Shorter J, Gitler AD, TDP-43 is intrinsically aggregation-prone, and amyotrophic lateral sclerosis-linked mutations accelerate aggregation and increase toxicity. *J Biol Chem* 2009;284:20329-20339.
- (163) Kabashi E, Lin L, Tradewell ML. Gain and loss of function of ALS-related mutations of TARDBP (TDP-43) cause motor deficits in vivo. *Hum Mol Genet* 2010;19:671-683.
- (164) Barmada SJ, Skibinski G, Korb E, Rao EJ, Wu JY, Finkbeiner S. Cytoplasmic mislocalization of TDP-43 is toxic to neurons and enhanced by a mutation associated with familial amyotrophic lateral sclerosis. *J Neurosci* 2010;30:639-649.
- (165) Nonaka T, Kametani F, Arai T, Akiyama H, Hasegawa M. Truncation and pathogenic mutations facilitate the formation of intracellular aggregates of TDP-43. *Hum Mol Genet* 2009;18:3353-3364.

- (166) Amador-Ortiz C, Lin WL, Ahmed Z et al. TDP-43 immunoreactivity in hippocampal sclerosis and Alzheimer's disease. *Ann Neurol* 2007;61:435-445.
- (167) Geser F, Winton MJ, Kwong LK et al. Pathological TDP-43 in parkinsonism-dementia complex and amyotrophic lateral sclerosis of Guam. *Acta Neuropathol* 2008;115:133-145.
- (168) Hasegawa M, Arai T, Akiyama H et al. TDP-43 is deposited in the Guam parkinsonism-dementia complex brains. *Brain* 2007;130:1386-1394.
- (169) Higashi S, Iseki E, Yamamoto R et al. Concurrence of TDP-43, tau and alpha-synuclein pathology in brains of Alzheimer's disease and dementia with Lewy bodies. *Brain Res* 2007;1184:284-294.
- (170) King A, Sweeney F, Bodi I, Troakes C, Maekawa S, Al-Sarraj S. Abnormal TDP-43 expression is identified in the neocortex in cases of dementia pugilistica, but is mainly confined to the limbic system when identified in high and moderate stages of Alzheimer's disease. *Neuropathology* 2010;30:408-419.
- (171) Lippa CF, Rosso AL, Stutzbach LD, Neumann M, Lee VM, Trojanowski JQ, Transactive response DNA-binding protein 43 burden in familial Alzheimer disease and Down syndrome. *Arch Neurol* 2009;66:1483-1488.
- (172) Nakashima-Yasuda H, Uryu K, Robinson J et al. Co-morbidity of TDP-43 proteinopathy in Lewy body related diseases. *Acta Neuropathol* 2007;114:221-229.
- (173) Schwab C, Arai T, Hasegawa M, Akiyama H, Yu S, McGeer PL. TDP-43 pathology in familial British dementia. *Acta Neuropathol* 2009;118:303-311.
- (174) Schwab C, Arai T, Hasegawa M, Yu S, McGeer PL. Colocalization of transactivation-responsive DNA-binding protein 43 and huntingtin in inclusions of Huntington disease. *J Neuropathol Exp Neurol* 2008;67:1159-1165.
- (175) Kuo PH, Doudeva LG, Wang YT, Shen CK, Yuan HS. Structural insights into TDP-43 in nucleic-acid binding and domain interactions. *Nucleic Acids Res* 2009;37:1799-1808.
- (176) Ou SH, Wu F, Harrich D, Garcia-Martinez LF, Gaynor RB. Cloning and characterization of a novel cellular protein, TDP-43, that binds to human immunodeficiency virus type 1 TAR DNA sequence motifs. *J Virol* 1995;69:3584-3596.
- (177) Buratti E, Brindisi A, Giombi M, Tisminetzky S, Ayala YM, Baralle FE. TDP-43 binds heterogeneous nuclear ribonucleoprotein A/B through its C-terminal tail: an important region for the inhibition of cystic fibrosis transmembrane conductance regulator exon 9 splicing. *J Biol Chem* 2005;280:37572-37584.
- (178) Buratti E, Dork T, Zuccato E, Pagani F, Romano M, Baralle FE. Nuclear factor TDP-43 and SR proteins promote in vitro and in vivo CFTR exon 9 skipping. *EMBO J* 2001;20:1774-1784.
- (179) D'Ambrogio A, Buratti E, Stuani C et al. Functional mapping of the interaction between TDP-43 and hnRNP A2 in vivo. *Nucleic Acids Res* 2009;37:4116-4126.

- (180) Krecic AM, Swanson MS. hnRNP complexes: composition, structure, and function. *Curr Opin Cell Biol* 1999;11:363-371.
- (181) Lagier-Tourenne C, Cleveland DW. Rethinking ALS: the FUS about TDP-43. *Cell* 2009;136:1001-1004.
- (182) Strong MJ, Volkening K, Hammond R et al. TDP43 is a human low molecular weight neurofilament (hNFL) mRNA-binding protein. *Mol Cell Neurosci* 2007;35:320-327.
- (183) Wang IF, Wu LS, Chang HY, Shen CK. TDP-43, the signature protein of FTLD-U, is a neuronal activity-responsive factor. *J Neurochem* 2008;105:797-806.
- (184) Brengues M, Teixeira D, Parker R. Movement of eukaryotic mRNAs between polysomes and cytoplasmic processing bodies. *Science* 2005;310:486-489.
- (185) Kiebler MA, Bassell GJ. Neuronal RNA granules: movers and makers. *Neuron* 2006;51:685-690.
- (186) Ayala YM, Zago P, D'Ambrogio A et al. Structural determinants of the cellular localization and shuttling of TDP-43. *J Cell Sci* 2008;121:3778-3785.
- (187) Volkening K, Leystra-Lantz C, Yang W, Jaffee H, Strong MJ. Tar DNA binding protein of 43 kDa (TDP-43), 14-3-3 proteins and copper/zinc superoxide dismutase (SOD<sub>1</sub>) interact to modulate NFL mRNA stability. Implications for altered RNA processing in amyotrophic lateral sclerosis (ALS). *Brain Res* 2009;1305:168-182
- (188) Ge WW, Wen W, Strong W, Leystra-Lantz C, Strong MJ. Mutant copper-zinc superoxide dismutase binds to and destabilizes human low molecular weight neurofilament mRNA. *J Biol Chem* 2005;280:118-124.
- (189) Butcher LM, Meaburn E, Liu L et al. Genotyping pooled DNA on microarrays: a systematic genome screen of thousands of SNPs in large samples to detect QTLs for complex traits. *Behav Genet* 2004;34:549-555.
- (190) Canete-Soler R, Wu J, Zhai J, Shamim M, Schlaepfer WW. p190RhoGEF Binds to a destabilizing element in the 3' untranslated region of light neurofilament subunit mRNA and alters the stability of the transcript. *J Biol Chem* 2001;276:32046-32050.
- (191) Lin H, Zhai J, Schlaepfer WW. RNA-binding protein is involved in aggregation of light neurofilament protein and is implicated in the pathogenesis of motor neuron degeneration. *Hum Mol Genet* 2005;14:3643-3659.
- (192) Rico B, Beggs HE, Schahin-Reed D, Kimes N, Schmidt A, Reichardt LF. Control of axonal branching and synapse formation by focal adhesion kinase. *Nat Neurosci* 2004;7:1059-1069.
- (193) Volkening K, Leystra-Lantz C, Strong MJ. Human low molecular weight neurofilament (NFL) mRNA interacts with a predicted p190RhoGEF homologue (RGNEF) in humans. *Amyotroph Lateral Scler Jun* 2009;1:1-7.
- (194) Li X, Lu L, Bush D J et al. Mutant copper-zinc superoxide dismutase associated with amyotrophic lateral sclerosis binds to adenine/uridine-rich stability elements in the vascular endothelial growth factor 3'-untranslated region. *J Neurochem* 2009;108:1032-1044.



- (195) Lu L, Zheng L, Viera L et al. Mutant Cu/Zn-superoxide dismutase associated with amyotrophic lateral sclerosis destabilizes vascular endothelial growth factor mRNA and downregulates its expression. *J Neurosci* 2007;27:7929-7938.
- (196) Gros-Louis F, Lariviere R, Gowing G et al. A frameshift deletion in peripherin gene associated with amyotrophic lateral sclerosis. *J Biol Chem* 2004;279:45951-45956.
- (197) Leung CL, He CZ, Kaufmann P et al. A pathogenic peripherin gene mutation in a patient with amyotrophic lateral sclerosis. *Brain Pathol* 2004;14:290-296.
- (198) Strong MJ, Leystra-Lantz C, Ge WW. Intermediate filament steady-state mRNA levels in amyotrophic lateral sclerosis. *Biochem Biophys Res Commun* 2004;316:317-322.
- (199) Beaulieu JM, Nguyen MD, Julien JP. Late onset of motor neurons in mice overexpressing wild-type peripherin. *J Cell Biol* 1999;147:531-544.
- (200) Millicamps S, Robertson J, Lariviere R, Mallet J, Julien JP. Defective axonal transport of neurofilament proteins in neurons overexpressing peripherin. *J Neurochem* 2006;98:926-938.
- (201) Robertson J, Beaulieu JM, Doroudchi MM, Durham HD, Julien JP, Mushynski WE. Apoptotic death of neurons exhibiting peripherin aggregates is mediated by the proinflammatory cytokine tumor necrosis factor-alpha. *J Cell Biol* 2001;155:217-226.
- (202) Robertson J, Doroudchi MM, Nguyen MD et al. A neurotoxic peripherin splice variant in a mouse model of ALS. *J Cell Biol* 2003;160:939-949.
- (203) Xiao S, Tjostheim S, Sanelli T et al. An aggregate-inducing peripherin isoform generated through intron retention is upregulated in amyotrophic lateral sclerosis and associated with disease pathology. *J Neurosci* 2008;28:1833-1840.
- (204) Sanelli T, Xiao S, Horne P, Bilbao J, Zinman L, Robertson J. Evidence that TDP-43 is not the major ubiquitinated target within the pathological inclusions of amyotrophic lateral sclerosis. *J Neuropathol Exp Neurol* 2007;66:1147-1153.
- (205) Betley JN, Heinrich B, Vernos I, Sardet C, Prodon F, Deshler JO. Kinesin II mediates Vg1 mRNA transport in *Xenopus* oocytes. *Curr Biol* 2004;14:219-224.
- (206) Chevalier-Larsen E, Holzbaur EL. Axonal transport and neurodegenerative disease. *Biochim Biophys Acta* 2006;1762:1094-1108.
- (207) Kanai Y, Dohmae N, Hirokawa N. Kinesin transports RNA: isolation and characterization of an RNA-transporting granule. *Neuron* 2004;43:513-525.
- (208) Messitt TJ, Gagnon JA, Kreiling JA, Pratt CA, Yoon YJ, Mowry KL. Multiple kinesin motors coordinate cytoplasmic RNA transport on a subpopulation of microtubules in *Xenopus* oocytes. *Dev Cell* 2008;15:426-436.
- (209) Piper M, Holt C. RNA translation in axons. *Annu Rev Cell Dev Biol* 2004;20:505-523.

- (210) Waterman-Storer CM, Karki SB, Kuznetsov S. A et al. The interaction between cytoplasmic dynein and dynactin is required for fast axonal transport. *Proc Natl Acad Sci U S A* 1997;94:12180-12185.
- (211) Puls I, Jonnakuty C, LaMonte B et al. Mutant dynactin in motor neuron disease. *Nat Genet* 2003;33:455-456.
- (212) Munch C, Sedlmeier R, Meyer T et al. Point mutations of the p150 subunit of dynactin (DCTN1) gene in ALS. *Neurology* 2004;63:724-726.
- (213) Munch C, Rosenbohm A, Sperfeld AD et al. Heterozygous R1101K mutation of the DCTN1 gene in a family with ALS and FTD. *Ann Neurol* 2005;58:777-780.
- (214) Jiang YM, Yamamoto M, Tanaka F et al. Gene expressions specifically detected in motor neurons (dynactin 1, early growth response 3, acetyl-CoA transporter, death receptor 5, and cyclin C) differentially correlate to pathologic markers in sporadic amyotrophic lateral sclerosis. *J Neuropathol Exp Neurol* 2007;66:617-627.
- (215) Strom AL, Shi P, Zhang F et al. Interaction of amyotrophic lateral sclerosis (ALS)-related mutant copper-zinc superoxide dismutase with the dynein-dynactin complex contributes to inclusion formation. *J Biol Chem* 2008;283:22795-22805.
- (216) Motil J, Dubey M, Chan WK, Shea TB. Inhibition of dynein but not kinesin induces aberrant focal accumulation of neurofilaments within axonal neurites. *Brain Res* 2007;1164:125-131.
- (217) Teuling E, van Dis V, Wulf PS et al. A novel mouse model with impaired dynein/dynactin function develops amyotrophic lateral sclerosis (ALS)-like features in motor neurons and improves lifespan in SOD1-ALS mice. *Hum Mol Genet* 2008;17:2849-2862.
- (218) Laird FM, Farah MH, Ackerley S et al. Motor neuron disease occurring in a mutant dynactin mouse model is characterized by defects in vesicular trafficking. *J Neurosci* 2008;28:1997-2005.
- (219) LaMonte BH, Wallace KE, Holloway BA et al. Disruption of dynein/dynactin inhibits axonal transport in motor neurons causing late-onset progressive degeneration. *Neuron* 2002;34:715-727.
- (220) Landers JE, Melki J, Meininger V et al. Reduced expression of the Kinesin-Associated Protein 3 (KIFAP3) gene increases survival in sporadic amyotrophic lateral sclerosis. *Proc Natl Acad Sci U S A* 2009;106:9004-9009.
- (221) Gottardi CJ, den Elzen NR, Yap AS. When domestiques rebel: kinesins, cadherins and neuronal proliferation. *Nat Cell Biol* 2005;7:445-447.
- (222) Hirokawa N. Stirring up development with the heterotrimeric kinesin KIF3. *Traffic* 2000;1:29-34.
- (223) Takeda S, Yamazaki H, Seog DH, Kanai Y, Terada S, Hirokawa N. Kinesin superfamily protein 3 (KIF3) motor transports fodrin-associating vesicles important for neurite building. *J Cell Biol* 2000;148:1255-1265.

- (224) Tateno M, Kato S, Sakurai T, Nukina N, Takahashi R, Araki T. Mutant SOD1 impairs axonal transport of choline acetyltransferase and acetylcholine release by sequestering KAP3. *Hum Mol Genet* 2009;18:942-955.
- (225) Dupuis L, de Tapia M, Rene F et al. Differential screening of mutated SOD1 transgenic mice reveals early up-regulation of a fast axonal transport component in spinal cord motor neurons. *Neurobiol Dis* 2000;7:274-285.
- (226) Pantelidou M, Zographos SE, Lederer CW, Kyriakides T, Pfaffl MW, Santama N. Differential expression of molecular motors in the motor cortex of sporadic ALS. *Neurobiol Dis* 2007;26:577-589.
- (227) Benussi L, Ghidoni R, Pegoiani E, Moretti DV, Zanetti O, Binetti G. Progranulin Leu271LeufsX10 is one of the most common FTL and CBS associated mutations worldwide. *Neurobiol Dis* 2009;33:379-385.
- (228) Bernardi L, Tomaino C, Anfossi M et al. Novel PSEN1 and PGRN mutations in early-onset familial frontotemporal dementia. *Neurobiol Aging* 2009;30:1825-1833.
- (229) Cruts M, Kumar-Singh S, Van Broeckhoven C. Progranulin mutations in ubiquitin-positive frontotemporal dementia linked to chromosome 17q21. *Curr Alzheimer Res* 2006;3:485-491.
- (230) Le Ber I, Camuzat A, Hannequin D et al. Phenotype variability in progranulin mutation carriers: a clinical, neuropsychological, imaging and genetic study. *Brain* 2008;131:732-746.
- (231) Pickering-Brown SM, Rollinson S, Du Plessis D et al. Frequency and clinical characteristics of progranulin mutation carriers in the Manchester frontotemporal lobar degeneration cohort: comparison with patients with MAPT and no known mutations. *Brain* 2008;131:721-731.
- (232) van Swieten JC, Heutink P. Mutations in progranulin (GRN) within the spectrum of clinical and pathological phenotypes of frontotemporal dementia. *Lancet Neurol* 2008;7:965-974.
- (233) Bateman A, Bennett HP. The granulin gene family: from cancer to dementia. *Bioessays* 2009;31:1245-1254.
- (234) Ryan CL, Baranowski DC, Chitramuthu BP et al. Progranulin is expressed within motor neurons and promotes neuronal cell survival. *BMC Neurosci* 2009;10:130.
- (235) Rademakers R, Eriksen JL, Baker M et al. Common variation in the miR-659 binding-site of GRN is a major risk factor for TDP43-positive frontotemporal dementia. *Hum Mol Genet* 2008;17:3631-3642.
- (236) Galimberti D, Fenoglio C, Cortini F et al. GRN Variability Contributes to Sporadic Frontotemporal Lobar Degeneration. *J Alzheimers Dis* 2009;19:171-177.
- (237) Rollinson S, Rohrer JD, van der Zee J et al. No association of PGRN 3'UTR rs5848 in frontotemporal lobar degeneration. *Neurobiol Aging* 2011;32:754-755.
- (238) Simon-Sanchez J, Seelaar H, Bochdanovits Z, Deeg DJ, van Swieten JC, Heutink P. Variation at GRN 3'-UTR rs5848 is not associated with a risk of frontotemporal lobar degeneration in Dutch population. *PLoS One* 2009;4:e7494.

- (239) Schymick JC, Yang Y, Andersen PM et al. Progranulin mutations and amyotrophic lateral sclerosis or amyotrophic lateral sclerosis-frontotemporal dementia phenotypes. *J Neurol Neurosurg Psychiatry* 2007;78:754-756.
- (240) Sleegers K, Brouwers N, Maurer-Stroh S et al. Progranulin genetic variability contributes to amyotrophic lateral sclerosis. *Neurology* 2008;71:253-259.
- (241) Irwin D, Lippa CF, Rosso A. Progranulin (PGRN) expression in ALS: an immunohistochemical study. *J Neurol Sci* 2009;276:9-13.
- (242) Zhang YJ, Xu YF, Dickey CA et al. Progranulin mediates caspase-dependent cleavage of TAR DNA binding protein-43. *J Neurosci* 2007;27:10530-10534.
- (243) Kong Q, Shan X, Chang Y, Tashiro H, Lin CL. RNA oxidation: a contributing factor or an epiphenomenon in the process of neurodegeneration. *Free Radic Res* 2008;42:773-777.
- (244) Chang Y, Kong Q, Shan X et al. Messenger RNA oxidation occurs early in disease pathogenesis and promotes motor neuron degeneration in ALS. *PLoS One* 2008;3:e2849.



# 17

**“In ons lichaam ontstond niets om wille van het nut, maar wat ontstaan is, scheidt zijn eigen functie.”**

Lucretius, De Natuur van de Dingen.

# Characterization of *FUS/TLS* mutations in amyotrophic lateral sclerosis using RNA-Seq

Marka van Blitterswijk, Eric T. Wang, Brad A. Friedman, Pamela J. Keagle,  
Patrick Lowe, Ashley Lyn Leclerc, Leonard H. van den Berg, David E. Housman,  
Jan H. Veldink\*, John E. Landers\*

\* Contributed equally to this work.

Submitted for publication.

## Abstract

Amyotrophic lateral sclerosis (ALS) is a neurodegenerative disease resulting in severe muscle weakness and eventual death by respiratory failure. Although little is known about its pathogenesis, mutations in fused in sarcoma / translated in liposarcoma (*FUS/TLS*) are causative for familial ALS. *FUS/TLS* is a multifunctional protein that is involved in many aspects of RNA processing. To elucidate the role of *FUS/TLS* in ALS, we overexpressed wild-type and two mutant forms of *FUS/TLS* in HEK-293T cells, as well as *FUS/TLS* knockdown. This was followed by RNA-Seq to identify genes which displayed differential expression or altered splicing patterns. Pathway analysis revealed that overexpression of wild-type *FUS/TLS* regulates ribosomal genes, whereas knockdown of *FUS/TLS* additionally affects expression of spliceosome related genes. Furthermore, cells expressing mutant *FUS/TLS* displayed global transcription patterns more similar to cells overexpressing wild-type *FUS/TLS* than to the knockdown condition. This observation suggests that *FUS/TLS* mutants do not contribute to the pathogenesis of ALS through a loss-of-function. Finally, our results demonstrate that the p.R522G and p.R521G mutations display differences in their influence on transcription and splicing. Taken together, these results provide additional insights into the function of *FUS/TLS* and how mutations contribute to the development of ALS.



## Introduction

Amyotrophic lateral sclerosis (ALS) is a fatal neurodegenerative disease affecting upper and lower motor neurons causing progressive muscle weakness. Patients typically die within three to five years after onset of symptoms due to respiratory failure.<sup>1-3</sup> Although most cases are sporadic, approximately 10% of ALS cases are familial (FALS). Mutations in several genes are causative for FALS, including fused in sarcoma / translated in liposarcoma (*FUS/TLS*), superoxide dismutase-1 (*SOD1*), TAR DNA-binding protein (*TARDBP*), angiogenin (*ANG*), vesicle-associated membrane protein B (*VAPB*), optineurin (*OPTN*), and valosin-containing protein (*VCP*).<sup>4-8</sup> Recently, an expanded hexanucleotide repeat (GGGGCC) within chromosome 9 open reading frame 72 (*C9orf72*) has been identified in a large percentage (23.5-46%) of patients with ALS and frontotemporal dementia (FTD).<sup>9,10</sup>

Mutations in *FUS/TLS* have been reported in ~4% of FALS patients and infrequently in sporadic ALS cases.<sup>11</sup> *FUS/TLS* is also known as heterogeneous nuclear ribonucleoprotein P2 (hnRNP P2) and is involved in numerous aspects of RNA processing.<sup>12,13</sup> The *FUS/TLS* protein is 526 amino acids long and contains an N-terminal serine, tyrosine, glycine and glutamine (SYGQ)-rich region, an RNA-recognition motif (RRM), a C2/C2 zinc finger motif, multiple RGG-repeat regions and a nuclear localization signal (NLS) at the extreme C-terminus.<sup>14</sup> Together with Ewing's sarcoma (EWS) and TATA-binding protein-associated factor (TAFII68/TAF15), *FUS/TLS* belongs to a family called TET or FET. Since the vast majority of the ALS mutations occur in the NLS (amino acids 514-526) and result in cytoplasmic retention of the *FUS/TLS* protein, mutations could impair its function or lead to a toxic gain-of-function.<sup>15,16</sup> Even though mutations in *FUS/TLS* account for only a small fraction of FALS and sporadic ALS (SALS) patients, it has been suggested that *FUS/TLS* protein may be a common component of the cellular inclusions in non-*SOD1* ALS and other neurodegenerative conditions, implying a shared pathogenic pathway underlying SALS, non-*SOD1* FALS, ALS/FTD, and related disorders.<sup>17</sup>

Given the role of *FUS/TLS* in RNA processing, it could be hypothesized that mutant *FUS/TLS* contributes to ALS by altering expression of numerous genes. However, the influence of wild-type and mutant *FUS/TLS* on global expression has yet to be studied. Therefore, we have utilized RNA-Seq to investigate the normal function of *FUS/TLS* and to identify the spectrum of wild-type and mutant *FUS/TLS* targets. RNA-Seq is based on short-read high-throughput sequencing of the transcriptome which overcomes several of the limitations of microarrays, including relatively high background noise, small dynamic range, and a limited ability to distinguish different isoforms and allelic expression.<sup>18</sup> Towards this goal, we have performed RNA-Seq on cells expressing exogenous wild-

type *FUS/TLS*, two mutant forms of *FUS/TLS* (p.R521G, p.R522G) or small interfering RNA (siRNA) against *FUS/TLS*.

## Materials and methods

### Plasmid constructs

Human wild-type *FUS/TLS* (clone MGC-8537, Invitrogen), was inserted into a pcDNA3.1 vector containing an N-terminal V5 (Invitrogen) epitope tag BP and LR Clonase kits (Invitrogen). Mutations located in exon fifteen (p.Arg521Gly (p.R521G) and p.Arg522Gly (p.R522G)) were generated by using QuikChange II Site-Directed Mutagenesis kit (Stratagene). Sequencing was used to verify the orientation of the inserts and absence of PCR-induced mutations.

### Cell culture

HEK-293 cells optimized for transfections (HEK-293T) were cultured in Dulbecco's Modified Eagle's medium (DMEM) supplemented with 10% fetal calf serum and 4 mM L-glutamine. Transfections were performed with Lipofectamine 2000 transfection reagent (Invitrogen) according to the manufacturer's recommendations. Cells were transfected with either 4 µg of expression constructs or 50.0 pmol *Silencer* pre-designed siRNA directed against *FUS/TLS* (s5402, Applied Biosystems). To test the efficiency of transfections, cells were co-transfections with 0.4 µg pEGFP-C1 plasmid which expresses Green Fluorescent Protein (GFP, Clontech). After 24 hours, the medium was changed to DMEM and cells were analyzed at 48 hours post-transfection. Transfection efficiencies for all conditions were greater than 75%, as determined by immunofluorescence staining.

### Preparation of cell lysates

Transfected cells were washed in phosphate-buffered saline (PBS) and then detached with a cell scraper. An aliquot of the cell suspension was centrifuged, resuspended in TENN buffer ((50 mM Tris-HCl [pH 7.4], 5 mM EDTA, 150 mM NaCl, 0.5% Nonidet P-40) with Protease Inhibitor Cocktail (Roche) and analyzed by Western blot. Western blot analysis was performed using the following antibodies: rabbit anti-FUS/TLS (1:5,000, Bethyl Laboratories, A300-302A), mouse anti-V5 (1:5,000, Invitrogen, catalog # 37-7500), rabbit anti-GAPDH (1:15,000; Abcam, catalog # Ab22555), Odyssey IRDye anti-rabbit IgG (1:20,000) and Odyssey IRDye anti-mouse IgG (1:20,000). The Odyssey Infrared Imaging System (Li-cor) was used for quantification of the western blots.

RNA was isolated from the remaining cell suspension according to the RNeasy Mini Kit protocol (Qiagen).

### RNA-Seq and data analysis

RNA-Seq libraries were generated as described previously.<sup>19</sup> Briefly, polyA+ RNA was reverse transcribed using Superscript III and converted to double strand cDNA. Illumina adapters were ligated and libraries were amplified by PCR and size selected by gel electrophoresis prior to sequencing on an Illumina Genome Analyzer. Analysis of RNA-Seq was performed utilizing the software package ExpressionPlot:<sup>20</sup> gene expression levels were estimated by counting the number of reads mapping to constitutive exons for each gene and determining RPKM values (reads per kilobase of exon model per million uniquely mapped reads). P-values were calculated using Fisher's exact test for pairwise comparison between samples. For skipped exon analysis, p-values were determined based on the ratio of inclusion reads to the sum of skipping and flanking reads (Supplementary Materials and methods) using Fisher's exact test, which is shown to be conservative, as described elsewhere.<sup>20</sup> For intron retention analysis, p-values were based on the Fisher's exact test of inclusion and flanking reads between conditions (Supplementary Materials and methods). We generated MA plots per condition comparison to check for expression level dependent differential signals, which were absent (Supplementary Figure 17.1).

Events with Ensemble gene identifiers were subjected to further analysis. For the differential expression analysis, events without RPKM units were excluded. After Bonferroni multiple test correction, significant events (p-value < 0.05) were selected and used to perform functional annotation and functional domain analysis by KEGG pathway analysis. To avoid length-dependent bias,<sup>21</sup> two different background lists were initially utilized: the *Homo sapiens* background list as supplied by DAVID Functional Annotation Tool (<http://david.abcc.ncifcrf.gov/home.jsp>) and the list we generated for cells transfected with the vector. However, the results from the two approaches displayed few differences. Therefore, only analysis using the *Homo sapiens* background list is reported for all conditions.

### RT-PCR

To confirm gene expression levels detected by RNA-Seq, we performed RT-PCR for a subset of genes with SYBR Green PCR mix (Qiagen), according to the manufactures guidelines. For each of these genes the expression was compared between our five conditions (wild-type FUS/TLS, siRNA, mutants and vector). Ct values were collected

in quadruplicate for each condition, and delta-Ct values were normalized using GAPDH values for the same condition. Hereafter, the average Ct value for the vector condition was subtracted from the normalized Ct values (delta delta Ct) and the fold decrease change was calculated ( $2^{-(\text{delta delta Ct})}$ ). Subsequently, the relative expression was calculated ( $1/\text{fold decrease change}$ ). For analysis of alternative splicing, quadruplicate PCR products of our five conditions ran on a 2% gel, and bands were analyzed with ImageJ (<http://rsbweb.nih.gov/ij/>). For each condition, an unspliced:spliced ratio was calculated (average between quadruplicates).

## Results

To investigate the global effects of wild-type and mutant *FUS/TLS* protein on cellular transcription and splicing, HEK-293T cells were transfected with expression vectors encoding wild-type *FUS/TLS*, two *FUS/TLS* mutants (p.R521G and p.R522G) or siRNA directed against *FUS/TLS*. Transfection with an empty vector served as a control condition. RNA-Seq resulted in 24 to 31 million reads for each transfection condition (Supplementary Table 17.1). Quality control assessments revealed that >69.9% of reads uniquely mapped to the genome and less than 2.72% of reads were derived from ribosomal RNA (Supplementary Table 17.1). Analysis of the RNA-Seq data demonstrated that cells expressing either the wild-type or mutant *FUS/TLS* displayed a ~2-fold increase in expression whereas harboring cells siRNA displayed a ~4-fold decrease in *FUS/TLS* expression (Supplementary Figure 17.2). Interestingly, western blot analysis of an aliquot of the transfected cells used for RNA-Seq displayed lower levels of overexpression of the *FUS/TLS* mutants relative to the wild-type, suggesting that post-transcriptional regulation may influence *FUS/TLS* protein levels (Supplementary Figure 17.3).

To investigate the global influence on transcription, pathway analysis was performed for differentially expressed genes using the DAVID Functional Annotation Tool. This analysis revealed that overexpression of wild-type *FUS/TLS* (wild-type *FUS/TLS* versus vector) influences expression of ribosomal related genes, whereas knockdown of *FUS/TLS* expression (siRNA versus vector) influences expression of both ribosome and spliceosome related genes (Table 17.1, Supplementary Table 17.2). The differentially expressed genes encoded several ribosomal proteins, DEAD box proteins, RNA-binding motif proteins, hnRNPs, and splicing factors (Supplementary Table 17.3). Further analysis revealed that the differentially expressed genes often encoded proteins containing RNA recognition motifs, endoplasmic reticulum (ER) targeting sequences, and nucleotide-binding with alpha-beta plaits (Supplementary Table 17.4).

To understand the mechanism by which FUS/TLS mutants may contribute ALS pathogenesis, we determined whether the expression patterns induced by mutant *FUS/TLS* were more similar to reduced *FUS/TLS* expression or overexpressed wild-type *FUS/TLS*. Similarity to the reduced expression of *FUS/TLS* would suggest that the mutants act by a loss-of-function mechanism whereas similarity to overexpressed wild-type *FUS/TLS* would suggest a gain-of function for the mutants. Towards this end, the number of differentially expressed genes between each of the two FUS/TLS mutants and either

**Table 17.1** Functional pathway analysis of differentially expressed genes

| Group              | KEGG Pathway    | Count | P-value              | Benjamini and Hochberg, FDR, p-value |
|--------------------|-----------------|-------|----------------------|--------------------------------------|
| WT-FUS vs. vector  | Ribosome        | 14    | $5.1 \times 10^{-5}$ | $6.6 \times 10^{-3}$                 |
| siRNA vs. vector   | Spliceosome     | 34    | $1.4 \times 10^{-8}$ | $2.2 \times 10^{-6}$                 |
|                    | Ribosome        | 26    | $1.2 \times 10^{-7}$ | $1.0 \times 10^{-5}$                 |
| p.R521G vs. vector | Spliceosome     | 18    | $1.0 \times 10^{-8}$ | $9.2 \times 10^{-7}$                 |
| p.R522G vs. vector | Ribosome        | 15    | $4.0 \times 10^{-7}$ | $4.0 \times 10^{-5}$                 |
|                    | Spliceosome     | 15    | $3.5 \times 10^{-5}$ | $1.8 \times 10^{-3}$                 |
|                    | Mismatch repair | 6     | $8.0 \times 10^{-4}$ | $2.7 \times 10^{-2}$                 |
|                    | DNA replication | 7     | $9.1 \times 10^{-4}$ | $2.3 \times 10^{-2}$                 |

Abbreviations: WT-FUS = wild-type FUS/TLS, and FDR = False Discovery Rate.

**Table 17.2** Functional pathway analysis of differentially expressed genes

|         |                 | WT-FUS (n) | siRNA (n) | Fisher's exact, p-value |
|---------|-----------------|------------|-----------|-------------------------|
| p.R521G | Significant     | 566        | 863       | $5.4 \times 10^{-17}$   |
|         | Non-significant | 17,122     | 16,511    |                         |
| p.R522G | Significant     | 1,198      | 1,938     | $7.4 \times 10^{-47}$   |
|         | Non-significant | 16,610     | 15,582    |                         |
| p.R521G | Up-regulated    | 509        | 423       | $1.3 \times 10^{-62}$   |
|         | Down-regulated  | 57         | 440       |                         |
| p.R522G | Up-regulated    | 112        | 88        | $1.6 \times 10^{-7}$    |
|         | Down-regulated  | 1,086      | 1,849     |                         |

Abbreviation: n = number.

siRNA or wild-type *FUS/TLS* conditions was calculated. As shown in Table 17.2, both the p.R521G and p.R522G mutants displayed an increased number of differentially expressed genes when compared to reduced *FUS/TLS* expression than to overexpressed wild-type conditions (p-value < 0.0001 for both). In other words, the transcriptional profiles of cells expressing this *FUS/TLS* mutant more closely resembled that of overexpressed wild-type *FUS/TLS* than of reduced levels of *FUS/TLS*. These results suggest that the *FUS/TLS* mutants do not contribute to ALS pathogenesis through a loss-of-function.

To investigate whether the two *FUS/TLS* mutants differed in their influence on transcription, the direction of change for differentially expressed genes was compared. Interestingly, although the total number of genes that was regulated by p.R521G and p.R522G was not significantly different, there was a significant difference in the number of genes that was up/down-regulated. As shown in Table 17.3, p.R521G dramatically favored up-regulation of the differentially identified genes, whereas p.R522G favored down-regulation. Despite the fact that the two *FUS/TLS* mutants appeared to have opposite effects on differential gene expression, pathway analysis revealed that both mutants significantly influenced spliceosome related genes (Table 17.1). Additionally, the p.R522G mutant also altered ribosome, mismatch repair and DNA replication related genes. The identified genes encoded, amongst others, DEAD box proteins, hnRNPs, splicing factors, ribosomal proteins, exonuclease, replication factors, mini-chromosome maintenance complex components, and proliferating cell nuclear antigen (Supplementary Table 17.3). The top most differentially expressed gene (increased) in both mutants versus vector was nucleolin (*NCL*, ENSG00000115053), which was validated using RT-PCR (Supplementary Figure 17.4). In addition, eukaryotic translation elongation factor 2 (*EEF2*, ENSG00000167658) was the third most differentially expressed gene (increased) in p.R521G, and less so in p.R522G, which validated as well using RT-PCR (Supplementary Figure 17.4). The most significantly enriched protein domains were RNA recognition motifs, nucleotide-binding alpha-beta plaits and helicases (Supplementary Table 17.4).

**Table 17.3** The *FUS/TLS* p.R521G mutant causes increased up-regulation of genes as compared to the p.R522G mutant

|        |                      | p.R521G (n) | p.R522G (n) | Fisher's exact, p-value  |
|--------|----------------------|-------------|-------------|--------------------------|
| Vector | Significant          | 332         | 328         | 0.78                     |
|        | Non-significant      | 17,052      | 17,214      |                          |
| Vector | Increased expression | 297         | 8           | 3.7 x 10 <sup>-134</sup> |
|        | Decreased expression | 35          | 320         |                          |

We extended our analysis to investigate the influence on alternative splicing, in particular skipped exons. Comparison of overexpressed wild-type *FUS/TLS* to vector transfected cells resulted in only 32 significant events and did not reveal any functional pathways enriched by these events (Supplementary Table 17.2). In contrast, knockdown of *FUS/TLS* expression resulted in 579 significant changes in skipped exons splicing patterns, regardless of the relative amount of exon skipping between conditions (LORG, Supplementary Materials and methods). These changes were enriched in ribosome and spliceosome related genes (Supplementary Table 17.2). Pathway analysis of the p.R521G mutant revealed involvement of the ribosome related genes, whereas the p.R522G mutant also affected spliceosome related genes (Supplementary Table 17.2). Additionally, we detected a small significant difference in the number of genes that were affected by the p.R521G and p.R522G mutations, but there was no significant difference in the direction of this change (Table 17.4).

To further investigate the influence of *FUS/TLS* on alternative splicing, we similarly analyzed our results for genes displaying changes in retained introns. Overexpression of wild-type *FUS/TLS* revealed 3,116 significant retained intron events. Pathway analysis revealed these event were enriched in spliceosome, Huntington's disease, proteasome,

**Table 17.4** The *FUS/TLS* p.R521G mutant induces increased skipping of exons relative to the R522G mutant

|        |                    | p.R521G (n) | p.R522G (n) | Fisher's exact, p-value |
|--------|--------------------|-------------|-------------|-------------------------|
| Vector | Significant        | 106         | 64          | 0.0031                  |
|        | Non-significant    | 65,812      | 63,215      |                         |
| Vector | Increased skipping | 42          | 30          | 0.35                    |
|        | Decreased skipping | 64          | 34          |                         |

**Table 17.5** The *FUS/TLS* p.R522G mutant induces increased retention of introns relative to the R521G mutant

|        |                     | p.R521G (n) | p.R522G (n) | Fisher's exact, p-value |
|--------|---------------------|-------------|-------------|-------------------------|
| Vector | Significant         | 2,932       | 2,521       | $5.2 \times 10^{-8}$    |
|        | Non-significant     | 109,789     | 109,655     |                         |
| Vector | Increased retention | 621         | 1,086       | $6.3 \times 10^{-68}$   |
|        | Decreased retention | 2,311       | 1,435       |                         |

Parkinson's disease, oxidative phosphorylation, cell cycle, DNA replication, and pyrimidine metabolism related genes (Supplementary Table 17.2). Down-regulation of *FUS/TLS* resulted in 3,054 significant retained intron events that were involved in the same pathways. There was a significant difference in the number of genes that was affected by p.R521G and p.R522G (p-value  $5.2 \times 10^{-8}$ ). There was also a significant difference in the direction of this change. The p.R522G mutant displayed increased intron retention relative to the p.R521G mutant (Table 17.5). Pathway analysis revealed enrichment for genes related to the spliceosome, Huntington's disease, proteasome, DNA replication, cell cycle, pyrimidine metabolism oxidative phosphorylation, and RNA polymerase (Supplementary Table 17.2). If we restricted this analysis to the most differentially retained intron events (absolute LORF value above two (<sup>20</sup>)) then the number of events dropped to 75 for wild-type *FUS/TLS*. These 75 events included spliceosomal gene pre-mRNA-processing-splicing factor 8 (*PRPF8*, ENSG00000174231). We validated the RNA-Seq data for this gene by RT-PCR, and demonstrated similar splicing patterns across conditions between RT-PCR and RNA-Seq (Supplementary Figure 17.5).

## Discussion

To study the effects of wild-type and mutant forms of *FUS/TLS*, we utilized RNA-Seq analysis to investigate alterations in gene expression and alternative splicing. Our results show that wild-type *FUS/TLS* affects ribosomal and spliceosome related genes and that proteins containing RNA recognition motifs and nucleotide-binding alpha-beta plaits were most frequently influenced, confirming the important role of *FUS/TLS* in RNA processing pathways.<sup>12</sup> This role is strengthened by previous reports; it has already been shown that *FUS/TLS* associates with products of RNA polymerase II transcription, forms complexes with hnRNPs, and represses RNA polymerase III transcription.<sup>22-24</sup> Furthermore, *FUS/TLS* inhibits the acetyltransferase activities of CREB-binding protein (CBP) and p300 on cyclin D1 (*CCND1*),<sup>25</sup> and regulates the transcription factor nuclear factor kB (NF-kB).<sup>26;27</sup> *FUS/TLS* also engages in rapid nucleocytoplasmic shuttling,<sup>28</sup> associates with actin-dependent motor protein myosin Va (*MyoVa*),<sup>29;30</sup> and is a component of RNA granules that transport mRNAs.<sup>31</sup> Splicing factors, such as serine-arginine (SR) proteins form complexes with *FUS/TLS* and removal of *FUS/TLS* from the nuclear extract causes disturbances of the splicing factor equilibrium.<sup>32</sup>

*FUS/TLS* shows several structural and functional similarities with TDP-43. Mutations in TAR DNA-binding protein (*TARDBP*), which encodes TDP-43, have been identified in ~5% of the ALS patients.<sup>33</sup> Similar to *FUS/TLS*, the role of TDP-43 is diverse and includes



transcriptional regulation, splicing inhibition, regulation of mRNA transport, repression of translation, and mRNA degradation.<sup>32</sup> Recently, it has been shown that TDP-43 interacts with a diverse spectrum of RNAs with important functions in the brain.<sup>34</sup> Depletion of TDP-43 from mouse adult brain resulted in a reduction of long introns, which encode proteins involved in synaptic activity.<sup>35</sup> Deep sequencing further identified more than 4,300 TDP-43 RNA-binding partners in rat cortical neurons.<sup>36</sup> These RNA partners were particularly enriched for genes related to synaptic function, RNA metabolism, and neuronal development.<sup>36</sup> Thus, the RNA targets of both FUS/TLS and TDP-43 emphasize that alterations in RNA processing pathways play a central role in neurodegenerative diseases.<sup>33</sup>

In the present study, we have also revealed that FUS/TLS mutants are more similar to overexpression of wild-type *FUS/TLS* than to our knockdown condition. These results suggest that mutants do not contribute to ALS pathogenesis through a loss-of-function. These observations are supported by the recent finding that mutant phenotypes in *Caenorhabditis elegans* could not be rescued by overexpression of wild-type *FUS/TLS*.<sup>37</sup> In addition, our analysis identified differences between p.R521G and p.R522G FUS/TLS mutants. Differential expression analysis demonstrated that these mutations appeared to have opposite effects on transcriptional regulation. Moreover, both mutations influenced the spliceosome, but the p.R522G mutation also altered genes involved in ribosomal processes, mismatch repair, and DNA replication. Analysis of skipped exons revealed that both FUS/TLS mutants affected ribosomal genes; however, the p.R522G mutant additionally influenced spliceosome related genes. Retained intron analysis displayed that intron retention was more frequently detected for p.R522G than for p.R521G. These findings suggest that p.R522G mutations cause more profound changes than p.R521G mutations.

Previously, p.R521G and p.R522G mutations have been studied in several experimental models. Yeast strains have been developed expressing wild-type and mutant *FUS/TLS*.<sup>38-41</sup> Overexpression of both resulted in punctuate aggregates in the cytoplasm; p.R521G aggregated with very similar kinetics to wild-type FUS/TLS in protein aggregation assays.<sup>38-41</sup> *In vitro* studies, demonstrated that the p.R521G mutant caused a relatively mild cytoplasmic mislocalization, whereas p.R522G caused a strong mislocalization.<sup>42</sup> The p.R522G mutant was also investigated in neuroblastoma cells, and was shown to predominantly accumulate in the cytoplasm and formed aggregates varying in size and shape.<sup>43</sup> In *Caenorhabditis elegans*, the motor function and lifespan of the animals expressing p.R521G mutations was indistinguishable from wild-type FUS/TLS, whereas the p.R522G mutations caused a significant decrease in motor function and lifespan.<sup>44</sup>

These observations suggest that *FUS/TLS* mutants may act through differing but converging mechanism leading to ALS.

Among the specific molecular targets that were affected by the *FUS/TLS* mutants, we displayed that *NCL* and *EEF2* were in the top most differentially expressed genes. Both *NCL* and *EEF* are crucial for ribosomal and spliceosomal function, as are many other targets of the *FUS/TLS* mutants. We were able to validate the expression pattern of both *NCL* and *EEF2* using RT-PCR. In the skipped exons and retained introns analysis, we also identified proteins with spliceosomal and ribosomal functions among the most prominent molecular targets. These results underscore the function of *FUS/TLS* in the translation of mRNA to proteins and splicing of introns from pre-mRNAs, respectively. No overrepresentation was observed of other targets that are not directly involved in these pathways.

To summarize, we have shown that *FUS/TLS* is implicated in the regulation of ribosomal and spliceosome related genes, highlighting the importance of RNA processing pathways in the pathogenesis of ALS. Furthermore, the expression changes induced by the *FUS/TLS* mutants suggest that they do not contribute to ALS pathogenesis through a loss-of-function. Finally, our results demonstrate that the p.R522G and p.R521G mutations display differences in their influence on transcription and splicing. Taken together, these observations provide additional insights into the normal function of *FUS/TLS* and how mutations lead to the development of ALS.

## Acknowledgements

JEL acknowledges grant support from NIH/NINDS (1R01NS065847 and 1R01NS073873) and the UMASS CTSA Pilot Award Program (NIH Grant No. UL1RR031982).

## References

- (1) McGuire V, Longstreth WT, Jr., Koepsell TD, van BG. Incidence of amyotrophic lateral sclerosis in three counties in western Washington state. *Neurology* 1996;47:571-573.
- (2) Logroscino G, Traynor BJ, Hardiman O et al. Incidence of amyotrophic lateral sclerosis in Europe. *J Neurol Neurosurg Psychiatry* 2010;81:385-390.
- (3) Rowland LP, Shneider NA. Amyotrophic lateral sclerosis. *N Engl J Med* 2001;344:1688-1700.
- (4) van Blitterswijk M, van Vught PW, van Es MA et al. Novel optineurin mutations in sporadic amyotrophic lateral sclerosis patients. *Neurobiol Aging* 2011 Jul 27.

- (5) Johnson JO, Mandrioli J, Benatar M et al. Exome sequencing reveals VCP mutations as a cause of familial ALS. *Neuron* 2010;68:857-864.
- (6) Valdmanis PN, Rouleau GA. Genetics of familial amyotrophic lateral sclerosis. *Neurology* 2008;70:144-152.
- (7) Van Damme P, Robberecht W. Recent advances in motor neuron disease. *Curr Opin Neurol* 2009;22:486-492.
- (8) Maruyama H, Morino H, Ito H et al. Mutations of optineurin in amyotrophic lateral sclerosis. *Nature* 2010;465:223-226.
- (9) DeJesus-Hernandez M, Mackenzie IR, Boeve BF et al. Expanded GGGGCC Hexanucleotide Repeat in Noncoding Region of C9ORF72 Causes Chromosome 9p-Linked FTD and ALS. *Neuron* 2011;72:245-256.
- (10) Renton AE, Majounie E, Waite A et al. A Hexanucleotide Repeat Expansion in C9ORF72 Is the Cause of Chromosome 9p21-Linked ALS-FTD. *Neuron* 2011;72:257-268.
- (11) Mackenzie IR, Rademakers R, Neumann M. TDP-43 and FUS in amyotrophic lateral sclerosis and frontotemporal dementia. *Lancet Neurol* 2010;9:995-1007.
- (12) van Blitterswijk M, Landers JE. RNA processing pathways in amyotrophic lateral sclerosis. *Neurogenetics* 2010;11:275-290.
- (13) Calvio C, Neubauer G, Mann M, Lamond AI. Identification of hnRNP P2 as TLS/FUS using electrospray mass spectrometry. *RNA* 1995;1:724-733.
- (14) Gal J, Zhang J, Kwinter DM et al. Nuclear localization sequence of FUS and induction of stress granules by ALS mutants. *Neurobiol Aging* 2011;32:2323.e27-e40.
- (15) Kwiatkowski TJ, Jr., Bosco DA, Leclerc AL et al. Mutations in the FUS/TLS gene on chromosome 16 cause familial amyotrophic lateral sclerosis. *Science* 2009;323:1205-1208.
- (16) Vance C, Rogelj B, Hortobagyi T et al. Mutations in FUS, an RNA processing protein, cause familial amyotrophic lateral sclerosis type 6. *Science* 2009;323:1208-1211.
- (17) Deng HX, Zhai H, Bigio EH et al. FUS-immunoreactive inclusions are a common feature in sporadic and non-SOD1 familial amyotrophic lateral sclerosis. *Ann Neurol* 2010;67:739-748.
- (18) Wang Z, Gerstein M, Snyder M. RNA-Seq: a revolutionary tool for transcriptomics. *Nat Rev Genet* 2009;10:57-63.
- (19) Wang ET, Sandberg R, Luo S et al. Alternative isoform regulation in human tissue transcriptomes. *Nature* 2008;456:470-476.
- (20) Friedman BA, Maniatis T. ExpressionPlot: a web-based framework for analysis of RNA-Seq and microarray gene expression data. *Genome Biol* 2011;12:R69.
- (21) Oshlack A, Wakefield MJ. Transcript length bias in RNA-seq data confounds systems biology. *Biol Direct* 2009;4:14.

- (22) Zinszner H, Albalat R, Ron D. A novel effector domain from the RNA-binding protein TLS or EWS is required for oncogenic transformation by CHOP. *Genes Dev* 1994;8:2513-2526.
- (23) Bertolotti A, Lutz Y, Heard DJ, Chambon P, Tora L. hTAF(II)68, a novel RNA/ssDNA-binding protein with homology to the pro-oncoproteins TLS/FUS and EWS is associated with both TFIID and RNA polymerase II. *EMBO J* 1996;15:5022-5031.
- (24) Tan AY, Manley JL. TLS inhibits RNA polymerase III transcription. *Mol Cell Biol* 2010;30:186-196.
- (25) Wang X, Arai S, Song X et al. Induced ncRNAs allosterically modify RNA-binding proteins in cis to inhibit transcription. *Nature* 2008;454:126-130.
- (26) Goransson M, Andersson MK, Forni C et al. The myxoid liposarcoma FUS-DDIT3 fusion oncoprotein deregulates NF-kappaB target genes by interaction with NFKBIZ. *Oncogene* 2009;28:270-278.
- (27) Uranishi H, Tetsuka T, Yamashita M et al. Involvement of the pro-oncoprotein TLS (translocated in liposarcoma) in nuclear factor-kappa B p65-mediated transcription as a coactivator. *J Biol Chem* 2001;276:13395-13401.
- (28) Zinszner H, Sok J, Immanuel D, Yin Y, Ron D. TLS (FUS) binds RNA in vivo and engages in nucleocytoplasmic shuttling. *J Cell Sci* 1997;110 ( Pt 15):1741-1750.
- (29) Selamat W, Jamari I, Wang Y, Takumi T, Wong F, Fujii R. TLS interaction with NMDA R1 splice variant in retinal ganglion cell line RGC-5. *Neurosci Lett* 2009;450:163-166.
- (30) Yoshimura A, Fujii R, Watanabe Y, Okabe S, Fukui K, Takumi T. Myosin-Va facilitates the accumulation of mRNA/protein complex in dendritic spines. *Curr Biol* 2006;16:2345-2351.
- (31) Belly A, Moreau-Gachelin F, Sadoul R, Goldberg Y. Delocalization of the multifunctional RNA splicing factor TLS/FUS in hippocampal neurones: exclusion from the nucleus and accumulation in dendritic granules and spine heads. *Neurosci Lett* 2005;379:152-157.
- (32) Meissner M, Lopato S, Gotzmann J, Sauermann G, Barta A. Proto-oncoprotein TLS/FUS is associated to the nuclear matrix and complexed with splicing factors PTB, SRm160, and SR proteins. *Exp Cell Res* 2003;283:184-195.
- (33) Da Cruz S, Cleveland DW. Understanding the role of TDP-43 and FUS/TLS in ALS and beyond. *Curr Opin Neurobiol* 2011;21:904-919.
- (34) Tollervey JR, Curk T, Rogelj B et al. Characterizing the RNA targets and position-dependent splicing regulation by TDP-43. *Nat Neurosci* 2011;14:452-458.
- (35) Polymenidou M, Lagier-Tourenne C, Hutt KR et al. Long pre-mRNA depletion and RNA missplicing contribute to neuronal vulnerability from loss of TDP-43. *Nat Neurosci* 2011;14:459-468.
- (36) Sephton CF, Cenik C, Kucukural A et al. Identification of neuronal RNA targets of TDP-43-containing ribonucleoprotein complexes. *J Biol Chem* 2011;286:1204-1215.
- (37) Hoell JI, Larsson E, Runge S et al. RNA targets of wild-type and mutant FET family proteins. *Nat Struct Mol Biol* 2011;18:1428-1431.
- (38) Ju S, Tardiff DF, Han H et al. A Yeast Model of FUS/TLS-Dependent Cytotoxicity. *PLoS Biol* 2011;9:e1001052.

- (39) Sun Z, Diaz Z, Fang X et al. Molecular Determinants and Genetic Modifiers of Aggregation and Toxicity for the ALS Disease Protein FUS/TLS. *PLoS Biol* 2011;9:e1000614.
- (40) Kryndushkin D, Wickner RB, Shewmaker F. FUS/TLS forms cytoplasmic aggregates, inhibits cell growth and interacts with TDP-43 in a yeast model of amyotrophic lateral sclerosis. *Protein Cell* 2011;2:223-236.
- (41) Fushimi K, Long C, Jayaram N, Chen X, Li L, Wu JY. Expression of human FUS/TLS in yeast leads to protein aggregation and cytotoxicity, recapitulating key features of FUS proteinopathy. *Protein Cell* 2011;2:141-149.
- (42) Dormann D, Rodde R, Edbauer D et al. ALS-associated fused in sarcoma (FUS) mutations disrupt Transportin-mediated nuclear import. *EMBO J* 2010;29:2841-2857.
- (43) Shelkownikova TA, Ustyugov AA, Smirnov AP et al. FUS gene mutations associated with familial forms of amyotrophic lateral sclerosis affect cellular localization and aggregation properties of the encoded protein. *Dokl Biochem Biophys* 2011;438:123-126.
- (44) Murakami T, Yang SP, Xie L et al. ALS mutations in FUS cause neuronal dysfunction and death in *Caenorhabditis elegans* by a dominant gain-of-function mechanism. *Hum Mol Genet* 2012;21:1-9.

## SUPPLEMENT

### Supplementary Materials and methods

#### Formulas used for RNA-Seq analysis

Exon skipping:  $\text{Log}_2(\text{Inclusion:Skip+General Ratio})$  in the two groups, respectively. In formula  $LISGR_1 = \log_2((jup_1 + eal_1 + jdn_1) / (eup_1 + jsk_1 + edn_1))$  and analogously for  $LISGR_2$ .

Intron retention:  $\text{Log}_2(\text{Intron:Flank Ratio})$ . Log-Odds-Ratio (Flanking). In formula  $LORF = LIFR_2 - LIFR_1$ . The sign convention means that higher value indicates more intron retention (unspliced isoform) in the second group. This indicates the level of the intron relative to the flanking exons.

## Supplementary Tables

**Supplementary Table 17.1** Summary of RNA-Seq analysis

| Sample  | No. reads  | No. reads passing QC | % passing QC | Uniquely mapping | % uniquely mapping | No. ribosomal | % ribosomal | Splice junctions | % splice junctions |
|---------|------------|----------------------|--------------|------------------|--------------------|---------------|-------------|------------------|--------------------|
| WT-FUS  | 31,051,162 | 31,022,757           | 99.91        | 21,865,318       | 70.48              | 446,094       | 2.04        | 2,222,084        | 10.16              |
| p.R521G | 31,077,360 | 31,057,750           | 99.94        | 21,710,924       | 69.91              | 488,727       | 2.25        | 2,292,605        | 10.56              |
| p.R522G | 24,491,122 | 24,476,034           | 99.94        | 17,427,598       | 71.20              | 474,659       | 2.72        | 1,754,345        | 10.07              |
| siRNA   | 28,196,024 | 28,179,703           | 99.94        | 20,640,291       | 73.25              | 291,210       | 1.41        | 2,242,343        | 10.86              |
| Vector  | 27,295,832 | 27,273,639           | 99.92        | 19,416,054       | 71.19              | 421,688       | 2.17        | 1,983,350        | 10.22              |
| Average | 28,422,300 | 28,401,977           | 99.93        | 20,212,037       | 71.20              | 424,476       | 2.12        | 2,098,945        | 10.37              |

Abbreviations: WT-FUS = wild-type FUS/TLS, no. = number, and QC = quality control.

Supplementary Table 17.2 Functional annotation KEGG pathways

| Analysis                | Group                                    | KEGG pathway                | Count                | P-value               | Benjamini             |     |
|-------------------------|--|-----------------------------|----------------------|-----------------------|-----------------------|-----|
| Differential expression | WT-FUS vs. vector<br>siRNA vs. vector    | Ribosome                    | 14                   | $5.6 \times 10^{-6}$  | $7.2 \times 10^{-4}$  |     |
|                         |  | Spliceosome                 | 34                   | $7.1 \times 10^{-11}$ | $1.2 \times 10^{-8}$  |     |
|                         | p.R521G vs. vector<br>p.R522G vs. vector | Ribosome                    | 26                   | $1.9 \times 10^{-9}$  | $1.6 \times 10^{-7}$  |     |
|                         |  | Spliceosome                 | 18                   | $4.4 \times 10^{-10}$ | $4.1 \times 10^{-8}$  |     |
|                         | N/A                                      | Ribosome                    | 15                   | $3.1 \times 10^{-8}$  | $3.1 \times 10^{-6}$  |     |
|                         |  | Spliceosome                 | 15                   | $3.3 \times 10^{-6}$  | $1.7 \times 10^{-4}$  |     |
|                         |  | Mismatch repair             | 6                    | $2.4 \times 10^{-4}$  | $8.2 \times 10^{-3}$  |     |
|                         |  | DNA replication             | 7                    | $2.7 \times 10^{-4}$  | $6.8 \times 10^{-3}$  |     |
|                         |  | Cell cycle                  | 11                   | $1.3 \times 10^{-3}$  | $2.6 \times 10^{-2}$  |     |
|                         |  | N/A                         | N/A                  | N/A                   | N/A                   | N/A |
|                         |  | Ribosome                    | 18                   | $8.6 \times 10^{-11}$ | $8.9 \times 10^{-9}$  |     |
| Skipped exons           | WT-FUS vs. vector<br>siRNA vs. vector    | Spliceosome                 | 17                   | $2.0 \times 10^{-7}$  | $1.1 \times 10^{-5}$  |     |
|                         |  | Ribosome                    | 6                    | $1.6 \times 10^{-4}$  | $6.7 \times 10^{-3}$  |     |
|                         | p.R521G vs. vector<br>p.R522G vs. vector | Spliceosome                 | 6                    | $3.7 \times 10^{-4}$  | $1.4 \times 10^{-2}$  |     |
|                         |  | Ribosome                    | 5                    | $9.0 \times 10^{-4}$  | $1.6 \times 10^{-2}$  |     |
|                         | N/A                                      | Spliceosome                 | 50                   | $1.0 \times 10^{-16}$ | $1.9 \times 10^{-14}$ |     |
|                         |  | Huntington's disease        | 54                   | $3.9 \times 10^{-12}$ | $3.3 \times 10^{-10}$ |     |
|                         |  | Proteasome                  | 21                   | $2.7 \times 10^{-8}$  | $1.5 \times 10^{-6}$  |     |
|                         |  | Parkinson's disease         | 37                   | $4.9 \times 10^{-8}$  | $2.1 \times 10^{-6}$  |     |
|                         |  | Oxidative phosphorylation   | 37                   | $7.6 \times 10^{-8}$  | $2.6 \times 10^{-6}$  |     |
|                         |  | Cell cycle                  | 36                   | $8.6 \times 10^{-8}$  | $2.4 \times 10^{-6}$  |     |
|                         |  | DNA replication             | 17                   | $3.3 \times 10^{-7}$  | $7.9 \times 10^{-6}$  |     |
| Pyrimidine metabolism   |  | 29                          | $5.5 \times 10^{-7}$ | $1.2 \times 10^{-5}$  |                       |     |
| RNA polymerase          |  | 14                          | $2.3 \times 10^{-6}$ | $4.4 \times 10^{-5}$  |                       |     |
| Retained introns        | WT-FUS vs. vector                        | Aminoacyl-tRNA biosynthesis | 17                   | $2.7 \times 10^{-6}$  | $4.6 \times 10^{-5}$  |     |
|                         |  | Alzheimer's disease         | 38                   | $9.9 \times 10^{-6}$  | $1.5 \times 10^{-4}$  |     |
|                         |  | Nucleotide excision repair  | 16                   | $3.8 \times 10^{-5}$  | $5.3 \times 10^{-4}$  |     |
|                         |  |                             |                      |                       |                       |     |





Supplementary Table 17.2 Continued

| Analysis | Group              | KEGG pathway                | Count | P-value               | Benjamini             |
|----------|--------------------|-----------------------------|-------|-----------------------|-----------------------|
|          |                    | Oxidative phosphorylation   | 33    | $2.1 \times 10^{-6}$  | $5.2 \times 10^{-5}$  |
|          |                    | Aminoacyl-tRNA biosynthesis | 16    | $7.4 \times 10^{-6}$  | $1.6 \times 10^{-4}$  |
|          |                    | RNA polymerase              | 13    | $9.2 \times 10^{-6}$  | $1.7 \times 10^{-4}$  |
|          |                    | Parkinson's disease         | 31    | $1.3 \times 10^{-5}$  | $2.2 \times 10^{-4}$  |
|          |                    | Alzheimer's disease         | 34    | $1.1 \times 10^{-4}$  | $1.8 \times 10^{-3}$  |
|          |                    | Purine metabolism           | 32    | $1.8 \times 10^{-4}$  | $2.6 \times 10^{-3}$  |
|          |                    | Mismatch repair             | 10    | $2.9 \times 10^{-4}$  | $3.8 \times 10^{-3}$  |
|          |                    | Nucleotide excision repair  | 14    | $3.6 \times 10^{-4}$  | $4.4 \times 10^{-3}$  |
|          |                    | RNA degradation             | 15    | $1.7 \times 10^{-3}$  | $1.9 \times 10^{-2}$  |
|          |                    | Spliceosome                 | 46    | $4.3 \times 10^{-16}$ | $7.3 \times 10^{-14}$ |
|          |                    | Huntington's disease        | 47    | $1.5 \times 10^{-10}$ | $1.2 \times 10^{-8}$  |
|          |                    | Proteasome                  | 20    | $1.5 \times 10^{-8}$  | $8.4 \times 10^{-7}$  |
|          |                    | Pyrimidine metabolism       | 29    | $2.5 \times 10^{-8}$  | $1.0 \times 10^{-6}$  |
|          |                    | Cell cycle                  | 34    | $2.9 \times 10^{-8}$  | $9.4 \times 10^{-7}$  |
|          |                    | DNA replication             | 16    | $3.3 \times 10^{-7}$  | $8.9 \times 10^{-6}$  |
|          |                    | RNA polymerase              | 14    | $4.4 \times 10^{-7}$  | $1.0 \times 10^{-5}$  |
|          |                    | Purine metabolism           | 33    | $1.2 \times 10^{-5}$  | $2.5 \times 10^{-4}$  |
|          |                    | Aminoacyl-tRNA biosynthesis | 15    | $1.3 \times 10^{-5}$  | $2.4 \times 10^{-4}$  |
|          |                    | Parkinson's disease         | 29    | $1.8 \times 10^{-5}$  | $2.9 \times 10^{-4}$  |
|          |                    | Oxidative phosphorylation   | 27    | $1.7 \times 10^{-4}$  | $2.6 \times 10^{-3}$  |
|          |                    | Alzheimer's disease         | 30    | $6.1 \times 10^{-4}$  | $8.3 \times 10^{-3}$  |
|          |                    | Citrate cycle (TCA cycle)   | 10    | $1.8 \times 10^{-3}$  | $2.2 \times 10^{-2}$  |
|          |                    | Nucleotide excision repair  | 12    | $2.2 \times 10^{-3}$  | $2.5 \times 10^{-2}$  |
|          |                    | RNA degradation             | 14    | $2.2 \times 10^{-3}$  | $2.4 \times 10^{-2}$  |
|          | p.R522G vs. vector |                             |       |                       |                       |

Abbreviation: N/A = not applicable. Significant KEGG pathways are shown for each condition. *Homo sapiens* is used as background, in Table 17.1 the empty vector is used as background. Genes are specified in Supplementary Table 17.3.

**Supplementary Table 17.3** Differentially expressed genes present within identified KEGG pathways

| Group             | KEGG pathway   | Name           | Description  |
|-------------------|--|----------------|--|
| WT-FUS vs. vector | Ribosome   | <i>RPL13</i>   | ribosomal protein L13                                |
|                   |  | <i>RPL18</i>   | ribosomal protein L18                                |
|                   |  | <i>RPL26</i>   | ribosomal protein L26                                |
|                   |  | <i>RPL29</i>   | ribosomal protein L29                                |
|                   |  | <i>RPL37A</i>  | ribosomal protein L37a                               |
|                   |  | <i>RPL8</i>    | ribosomal protein L8                                 |
|                   |  | <i>RPS11</i>   | ribosomal protein S11                                |
|                   |  | <i>RPS16</i>   | ribosomal protein S16                                |
|                   |  | <i>RPS19</i>   | ribosomal protein S19                                |
|                   |  | <i>RPS3</i>    | ribosomal protein S3                                 |
|                   |  | <i>RPS4X</i>   | ribosomal protein S4X                                |
|                   |  | <i>RPS6</i>    | ribosomal protein S6                                 |
|                   |  | <i>RPLP0</i>   | ribosomal protein, large, P0                         |
|                   |  | <i>RPLP2</i>   | ribosomal protein, large, P2                         |
| siRNA vs. vector  | Spliceosome  | <i>DDX23</i>   | DEAD (Asp-Glu-Ala-Asp) box polypeptide 23            |
|                   |  | <i>DDX46</i>   | DEAD (Asp-Glu-Ala-Asp) box polypeptide 46            |
|                   |  | <i>BAT1</i>    | HLA-B associated transcript 1                        |
|                   |  | <i>LSM2</i>    | LSM2 homolog, U6 small nuclear RNA associated        |
|                   |  | <i>PRP19</i>   | PRP19/PSO4 pre-mRNA processing factor 19 homolog     |
|                   |  | <i>PRPF40A</i> | PRP40 pre-mRNA processing factor 40 homolog A        |
|                   |  | <i>PRPF8</i>   | PRP8 pre-mRNA processing factor 8 homolog            |
|                   |  | <i>RBM17</i>   | RNA-binding motif protein 17                         |
|                   |  | <i>RBM25</i>   | RNA-binding motif protein 25                         |
|                   |  | <i>THOC2</i>   | THO complex 2  |
|                   |  | <i>THOC4</i>   | THO complex 4  |
|                   |  | <i>U2AFBP</i>  | U2 small nuclear RNA auxiliary factor 1              |
|                   |  | <i>SR140</i>   | U2-associated SR140 protein                          |
|                   |  | <i>ACIN1</i>   | apoptotic chromatin condensation inducer 1           |
|                   |  | <i>EFTUD2</i>  | elongation factor Tu GTP binding domain containing 2 |
|                   |  | <i>HSPA1A</i>  | heat shock 70kDa protein 1B                          |
|                   |  | <i>HSPA8</i>   | heat shock 70kDa protein 8                           |
|                   |  | <i>HNRNPA1</i> | heterogeneous nuclear ribonucleoprotein A1-like 3    |
|                   |  | <i>HNRNPM</i>  | heterogeneous nuclear ribonucleoprotein M            |
|                   |  | <i>HNRNPU</i>  | heterogeneous nuclear ribonucleoprotein U            |
| <i>SNRNP200</i>   | similar to U5 snRNP-specific protein, 200 kDa        |                |  |
| <i>SNRPD1</i>     | small nuclear ribonucleoprotein D1 polypeptide 16kDa |                |  |

*Supplementary Table 17.3 continues on next page*

**Supplementary Table 17.3** *Continued*

| Group              | KEGG pathway | Name           | Description   |
|--------------------|--------------|----------------|---|
|                    |              | <i>SNRPB</i>   | small nuclear ribonucleoprotein polypeptides B and B1 |
|                    |              | <i>SF3B1</i>   | splicing factor 3b, subunit 1, 155kDa                 |
|                    |              | <i>SF3B2</i>   | splicing factor 3b, subunit 2, 145kDa                 |
|                    |              | <i>SFRS1</i>   | splicing factor, arginine/serine-rich 1               |
|                    |              | <i>SFRS2</i>   | splicing factor, arginine/serine-rich 2               |
|                    |              | <i>SFRS4</i>   | splicing factor, arginine/serine-rich 4               |
|                    |              | <i>SFRS6</i>   | splicing factor, arginine/serine-rich 6               |
|                    |              | <i>SFRS7</i>   | splicing factor, arginine/serine-rich 7, 35kDa        |
|                    |              | <i>TXNL4A</i>  | thioredoxin-like 4A                                   |
|                    |              | <i>TCERG1</i>  | transcription elongation regulator 1                  |
|                    |              | <i>USP39</i>   | ubiquitin specific peptidase 39                       |
|                    |              | <i>ZMAT2</i>   | zinc finger, matrin type 2                            |
|                    | Ribosome     | <i>RPL10</i>   | ribosomal protein L10                                 |
|                    |              | <i>RPL10A</i>  | ribosomal protein L10a                                |
|                    |              | <i>RPL13</i>   | ribosomal protein L13                                 |
|                    |              | <i>RPL14</i>   | ribosomal protein L14                                 |
|                    |              | <i>RPL15</i>   | ribosomal protein L15                                 |
|                    |              | <i>RPL18</i>   | ribosomal protein L18                                 |
|                    |              | <i>RPL23</i>   | ribosomal protein L23                                 |
|                    |              | <i>RPL24</i>   | ribosomal protein L24                                 |
|                    |              | <i>RPL26</i>   | ribosomal protein L26                                 |
|                    |              | <i>RPL28</i>   | ribosomal protein L28                                 |
|                    |              | <i>RPL29</i>   | ribosomal protein L29                                 |
|                    |              | <i>RPL30</i>   | ribosomal protein L30                                 |
|                    |              | <i>RPL35A</i>  | ribosomal protein L35a                                |
|                    |              | <i>RPL36AL</i> | ribosomal protein L36a-like                           |
|                    |              | <i>RPL38</i>   | ribosomal protein L38                                 |
|                    |              | <i>RPL3</i>    | ribosomal protein L3                                  |
|                    |              | <i>RPL5</i>    | ribosomal protein L5                                  |
|                    |              | <i>RPL7A</i>   | ribosomal protein L7a                                 |
|                    |              | <i>RPS11</i>   | ribosomal protein S11                                 |
|                    |              | <i>RPS16</i>   | ribosomal protein S16                                 |
|                    |              | <i>RPS19</i>   | ribosomal protein S19                                 |
|                    |              | <i>RPS20</i>   | ribosomal protein S20                                 |
|                    |              | <i>RPS23</i>   | ribosomal protein S23                                 |
|                    |              | <i>RPS29</i>   | ribosomal protein S29                                 |
|                    |              | <i>RPS3</i>    | ribosomal protein S3                                  |
|                    |              | <i>RPS6</i>    | ribosomal protein S6                                  |
| p.R521G vs. vector | Spliceosome  | <i>DDX23</i>   | DEAD (Asp-Glu-Ala-Asp) box polypeptide 23             |
|                    |              | <i>PRPF8</i>   | PRP8 pre-mRNA processing factor 8 homolog             |
|                    |              | <i>RBM25</i>   | RNA-binding motif protein 25                          |
|                    |              | <i>THOC4</i>   | THO complex 4   |

| Group              | KEGG pathway | Name            | Description   |
|--------------------|--------------|-----------------|---|
|                    |              | <i>U2AF2</i>    | U2 small nuclear RNA auxiliary factor 2                         |
|                    |              | <i>SR140</i>    | U2-associated SR140 protein                                     |
|                    |              | <i>ACIN1</i>    | apoptotic chromatin condensation inducer 1                      |
|                    |              | <i>CTBL1</i>    | catenin, beta like 1  |
|                    |              | <i>HSPA8</i>    | heat shock 70kDa protein 8                                      |
|                    |              | <i>HNRNPU</i>   | heterogeneous nuclear ribonucleoprotein U                       |
|                    |              | <i>PCBP1</i>    | poly(rC) binding protein 1                                      |
|                    |              | <i>PRPF6</i>    | similar to U5 snRNP-associated 102 kDa protein                  |
|                    |              | <i>SNRNP200</i> | similar to U5 snRNP-specific protein, 200 kDa                   |
|                    |              | <i>SF3A1</i>    | splicing factor 3a, subunit 1, 120kDa                           |
|                    |              | <i>SFRS4</i>    | splicing factor, arginine/serine-rich 4                         |
|                    |              | <i>SART1</i>    | squamous cell carcinoma antigen recognized by T cells           |
|                    |              | <i>TCERG1</i>   | transcription elongation regulator 1                            |
|                    |              | <i>ZMAT2</i>    | zinc finger, matrin type 2                                      |
| p.R522G vs. vector | Spliceosome  | <i>CDC5L</i>    | CDC5 cell division cycle 5-like                                 |
|                    |              | <i>DDX46</i>    | DEAD (Asp-Glu-Ala-Asp) box polypeptide 46                       |
|                    |              | <i>DDX5</i>     | DEAD (Asp-Glu-Ala-Asp) box polypeptide 5                        |
|                    |              | <i>DDX15</i>    | DEAH (Asp-Glu-Ala-His) box polypeptide 15                       |
|                    |              | <i>FUSIP1</i>   | FUS interacting protein (serine/arginine-rich) 1                |
|                    |              | <i>PRPF38B</i>  | PRP38 pre-mRNA processing factor 38 (yeast) domain containing B |
|                    |              | <i>THOC2</i>    | THO complex 2   |
|                    |              | <i>HNRNPM</i>   | heterogeneous nuclear ribonucleoprotein M                       |
|                    |              | <i>HNRNPU</i>   | heterogeneous nuclear ribonucleoprotein U                       |
|                    |              | <i>NCBP1</i>    | nuclear cap binding protein subunit 1, 80kDa                    |
|                    |              | <i>RNRPB</i>    | small nuclear ribonucleoprotein polypeptides B and B1           |
|                    |              | <i>SF3B1</i>    | splicing factor 3b, subunit 1, 155kDa                           |
|                    |              | <i>SFRS2</i>    | splicing factor, arginine/serine-rich 2                         |
|                    |              | <i>SFRS5</i>    | splicing factor, arginine/serine-rich 5                         |
|                    |              | <i>SFRS7</i>    | splicing factor, arginine/serine-rich 7, 35kDa                  |
|                    | Ribosome     | <i>RPL10</i>    | ribosomal protein L10   |
|                    |              | <i>RPL11</i>    | ribosomal protein L11   |
|                    |              | <i>RPL23</i>    | ribosomal protein L23   |
|                    |              | <i>RPL26</i>    | ribosomal protein L26   |
|                    |              | <i>RPL29</i>    | ribosomal protein L29   |
|                    |              | <i>RPL34</i>    | ribosomal protein L34   |
|                    |              | <i>RPL4</i>     | ribosomal protein L4  |
|                    |              | <i>RPS16</i>    | ribosomal protein S16   |
|                    |              | <i>RPS19</i>    | ribosomal protein S19   |

Supplementary Table 17.3 continues on next page

**Supplementary Table 17.3** *Continued*

| Group | KEGG pathway    | Name          | Description   |
|-------|-----------------|---------------|---|
|       |                 | <i>RPS20</i>  | ribosomal protein S20   |
|       |                 | <i>RPS24</i>  | ribosomal protein S24   |
|       |                 | <i>RPS29</i>  | ribosomal protein S29   |
|       |                 | <i>RPS3</i>   | ribosomal protein S3  |
|       |                 | <i>RPS4X</i>  | ribosomal protein S4, X-linked  |
|       |                 | <i>RPS6</i>   | ribosomal protein S6  |
|       | Mismatch repair | <i>EXO1</i>   | exonuclease 1   |
|       |                 | <i>MSH2</i>   | mutS homolog 2, colon cancer, nonpolyposis type 1   |
|       |                 | <i>PCNA</i>   | proliferating cell nuclear antigen  |
|       |                 | <i>RFC1</i>   | replication factor C (activator 1) 1, 145kDa  |
|       |                 | <i>RFC5</i>   | replication factor C (activator 1) 5, 36.5kDa   |
|       |                 | <i>SSBP1</i>  | single-stranded DNA binding protein 1   |
|       | DNA replication | <i>MCM4</i>   | minichromosome maintenance complex component 4  |
|       |                 | <i>MCM6</i>   | minichromosome maintenance complex component 6  |
|       |                 | <i>MCM7</i>   | minichromosome maintenance complex component 7  |
|       |                 | <i>PCNA</i>   | proliferating cell nuclear antigen  |
|       |                 | <i>RFC1</i>   | replication factor C (activator 1) 1, 145kDa  |
|       |                 | <i>RFC5</i>   | replication factor C (activator 1) 5, 36.5kDa   |
|       |                 | <i>SSBP1</i>  | single-stranded DNA binding protein 1   |
|       | Cell cycle      | <i>CDC25A</i> | cell division cycle 25 homolog A ( <i>S. pombe</i> )                                      |
|       |                 | <i>HDAC2</i>  | histone deacetylase 2   |
|       |                 | <i>MCM4</i>   | minichromosome maintenance complex component 4  |
|       |                 | <i>MCM6</i>   | minichromosome maintenance complex component 6  |
|       |                 | <i>MCM7</i>   | minichromosome maintenance complex component 7  |
|       |                 | <i>PLK1</i>   | polo-like kinase 1 ( <i>Drosophila</i> )  |
|       |                 | <i>PCNA</i>   | proliferating cell nuclear antigen  |
|       |                 | <i>YWHAE</i>  | similar to 14-3-3 protein epsilon (14-3-3E)   |
|       |                 | <i>PRKDC</i>  | similar to protein kinase, DNA-activated, catalytic polypeptide                           |
|       |                 | <i>STAG2</i>  | stromal antigen 2   |
|       |                 | <i>YWHAQ</i>  | tyrosine 3-monooxygenase/tryptophan 5-monooxygenase activation protein, theta polypeptide |

**Supplementary Table 17.4** Significant protein domains present in differentially expressed genes

| Group   | INTERPRO                                    | Count                                | P-value               | Benjamini             |
|---|---|--------------------------------------|-----------------------|-----------------------|
| WT-FUS vs. vector                                     | RNA recognition motif, RNP-1                | 20                                   | $7.2 \times 10^{-7}$  | $6.0 \times 10^{-4}$  |
|   | Endoplasmic reticulum, targeting sequence   | 10                                   | $9.2 \times 10^{-7}$  | $3.8 \times 10^{-4}$  |
|   | Nucleotide-binding, alpha-beta plait        | 17                                   | $5.2 \times 10^{-5}$  | $1.4 \times 10^{-2}$  |
| siRNA vs. vector                                      | Nucleotide-binding, alpha-beta plait        | 48                                   | $3.2 \times 10^{-14}$ | $5.4 \times 10^{-11}$ |
|   | RNA recognition motif, RNP-1                | 46                                   | $4.1 \times 10^{-13}$ | $3.5 \times 10^{-10}$ |
|   | Zinc finger, PHD-type                       | 19                                   | $1.2 \times 10^{-5}$  | $6.6 \times 10^{-3}$  |
|   | Zinc finger, PHD-finger                     | 18                                   | $2.1 \times 10^{-5}$  | $8.6 \times 10^{-3}$  |
|   | Helicase, superfamily 1 and 2, ATP-binding  | 20                                   | $4.0 \times 10^{-5}$  | $1.3 \times 10^{-2}$  |
|   | DEAD-like helicase, N-terminal              | 20                                   | $5.2 \times 10^{-5}$  | $1.5 \times 10^{-2}$  |
|   | Actinin-type, actin-binding, conserved site | 9                                    | $5.4 \times 10^{-5}$  | $1.3 \times 10^{-2}$  |
|   | Zinc finger, PHD-type, conserved site       | 18                                   | $6.9 \times 10^{-5}$  | $1.4 \times 10^{-2}$  |
|   | K Homology                                  | 11                                   | $7.4 \times 10^{-5}$  | $1.4 \times 10^{-2}$  |
|   | DNA/RNA helicase, C-terminal                | 19                                   | $1.3 \times 10^{-4}$  | $2.2 \times 10^{-2}$  |
| p.R521G vs. vector                                    | RNA recognition motif, RNP-1                | 28                                   | $1.9 \times 10^{-15}$ | $1.2 \times 10^{-12}$ |
|   | Nucleotide-binding, alpha-beta plait        | 27                                   | $2.0 \times 10^{-14}$ | $6.3 \times 10^{-12}$ |
|   | DNA/RNA helicase, C-terminal                | 12                                   | $4.3 \times 10^{-6}$  | $8.9 \times 10^{-4}$  |
|   | Helicase, superfamily 1 and 2, ATP-binding  | 12                                   | $4.3 \times 10^{-6}$  | $8.9 \times 10^{-4}$  |
|   | DEAD-like helicase, N-terminal              | 12                                   | $5.2 \times 10^{-6}$  | $8.0 \times 10^{-4}$  |
|   | Zinc finger, PHD-finger                     | 10                                   | $2.6 \times 10^{-5}$  | $3.2 \times 10^{-3}$  |
|   | Zinc finger, PHD-type                       | 10                                   | $4.1 \times 10^{-5}$  | $4.2 \times 10^{-3}$  |
|   | DNA-binding SAP                             | 6                                    | $5.2 \times 10^{-5}$  | $4.6 \times 10^{-3}$  |
|   | SNF2-related                                | 6                                    | $2.7 \times 10^{-4}$  | $2.1 \times 10^{-2}$  |
|   | K Homology, type 1                          | 6                                    | $3.1 \times 10^{-4}$  | $2.1 \times 10^{-2}$  |
|   | K Homology, type 1, subgroup                | 6                                    | $4.2 \times 10^{-4}$  | $2.5 \times 10^{-2}$  |
|   | K Homology                                  | 6                                    | $5.4 \times 10^{-4}$  | $3.0 \times 10^{-2}$  |
|   | p.R521G vs. vector                          | Nucleotide-binding, alpha-beta plait | 20                    | $9.2 \times 10^{-9}$  |
| RNA recognition motif, RNP-1                          |   | 19                                   | $4.6 \times 10^{-8}$  | $1.6 \times 10^{-5}$  |
| HEAT  |   | 10                                   | $5.0 \times 10^{-7}$  | $1.1 \times 10^{-4}$  |
| Armadillo-like helical                                |   | 13                                   | $3.1 \times 10^{-6}$  | $5.3 \times 10^{-4}$  |
| RNA helicase, ATP-dependent, DEAD-box, conserved site |   | 7                                    | $1.9 \times 10^{-5}$  | $2.6 \times 10^{-3}$  |
| Chaperonin TCP-1, conserved site                      |   | 5                                    | $1.9 \times 10^{-5}$  | $2.2 \times 10^{-3}$  |
| Helicase, superfamily 1 and 2, ATP-binding            |   | 11                                   | $2.1 \times 10^{-5}$  | $2.1 \times 10^{-3}$  |
| DNA/RNA helicase, C-terminal                          |   | 11                                   | $2.1 \times 10^{-5}$  | $2.1 \times 10^{-3}$  |
| DEAD-like helicase, N-terminal                        |   | 11                                   | $2.5 \times 10^{-5}$  | $2.1 \times 10^{-3}$  |
| Chaperone, tailless complex polypeptide 1             |   | 5                                    | $3.0 \times 10^{-5}$  | $2.2 \times 10^{-3}$  |
| Nucleic acid-binding, OB-fold                         |   | 8                                    | $4.1 \times 10^{-5}$  | $2.8 \times 10^{-3}$  |

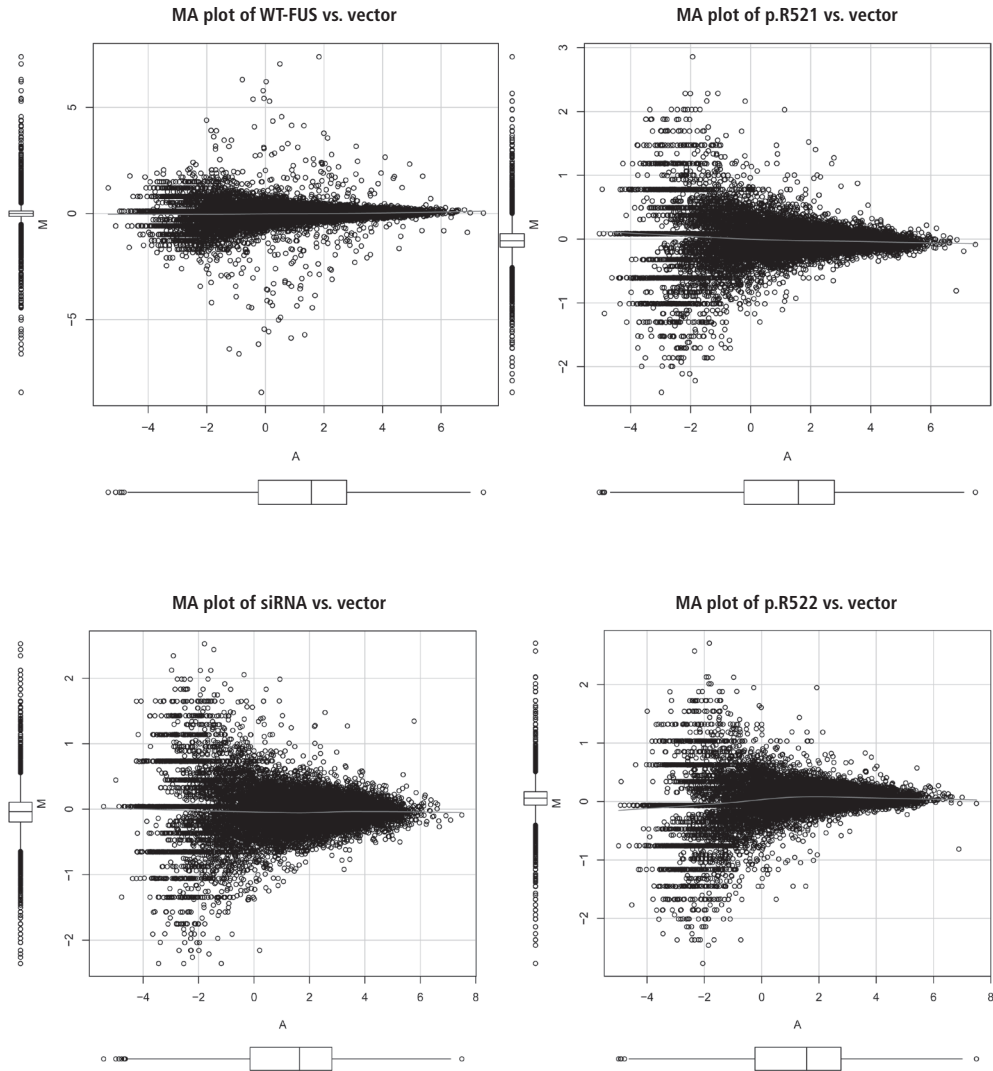
Supplementary Table 17.4 continues on next page

**Supplementary Table 17.4** *Continued*

| Group | INTERPRO   | Count | P-value              | Benjamini            |
|-------|--|-------|----------------------|----------------------|
|       | RNA helicase, DEAD-box type, Q motif   | 7     | $4.5 \times 10^{-5}$ | $2.8 \times 10^{-3}$ |
|       | DNA/RNA helicase, DEAD/DEAH box type, N-terminal                                     | 8     | $1.0 \times 10^{-4}$ | $5.8 \times 10^{-3}$ |
|       | Importin-beta, N-terminal  | 5     | $1.2 \times 10^{-4}$ | $6.1 \times 10^{-3}$ |
|       | Chaperonin Cpn60/TCP-1   | 5     | $1.2 \times 10^{-4}$ | $6.1 \times 10^{-3}$ |
|       | DNA-dependent ATPase MCM, conserved site   | 4     | $2.9 \times 10^{-4}$ | $1.4 \times 10^{-2}$ |
|       | DNA-dependent ATPase MCM   | 4     | $4.4 \times 10^{-4}$ | $2.0 \times 10^{-2}$ |
|       | ATPase, F1/V1/A1 complex, alpha/beta subunit, nucleotide-binding domain, active site | 4     | $1.1 \times 10^{-3}$ | $4.6 \times 10^{-2}$ |
|       | Heat shock protein Hsp90   | 4     | $1.1 \times 10^{-3}$ | $4.6 \times 10^{-2}$ |

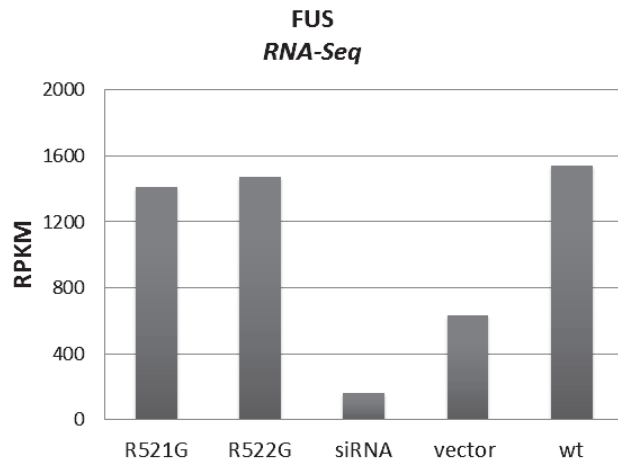


## Supplementary Figures

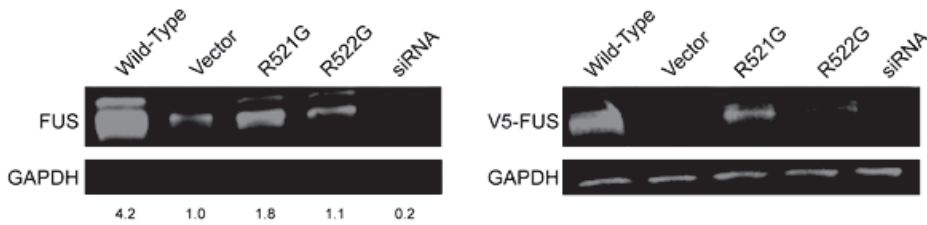


17

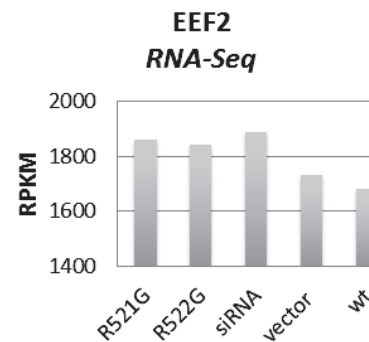
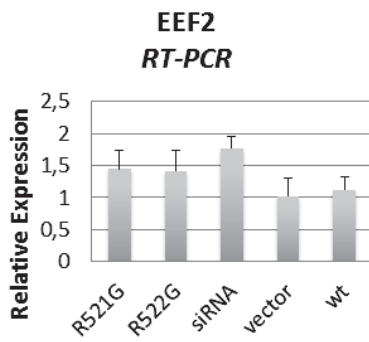
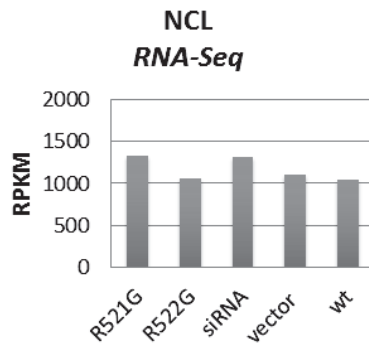
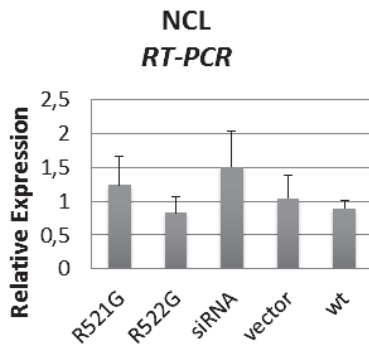
**Supplementary Figure 17.1** MA plots per condition comparison. MA plots per comparison where  $M = \log(\text{rpkm}_{\text{condition}}) - \log(\text{rpkm}_{\text{vector}})$  and  $A = 0.5 * (\log(\text{rpkm}_{\text{condition}}) + \log(\text{rpkm}_{\text{vector}}))$ . See Appendix page 388 for Supplementary Figure 17.1 in color.



**Supplementary Figure 17.2** *FUS/TLS* gene expression levels measured by RNA-Seq. Reads per kilobase of exon model per million uniquely mapped reads (RPKM) counts are displayed for each condition. Transfections with wild type *FUS/TLS*, p.R521G and p.R522G resulted in a ~2-fold increase in expression level, transfections with siRNA in a ~4-fold decrease in expression level.

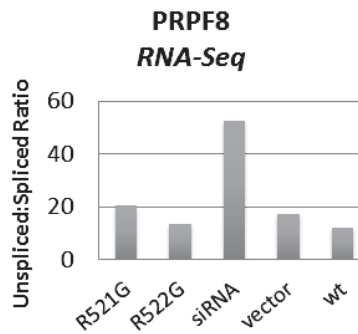
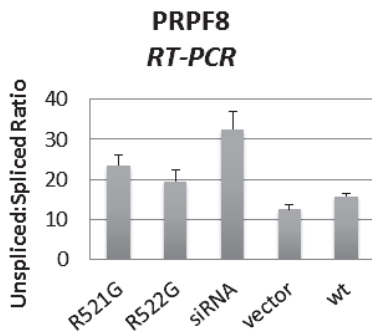


**Supplementary Figure 17.3** *FUS/TLS* protein levels measured by Western blot. We performed quantitative Western blot analysis and demonstrated siRNA caused a decrease in the *FUS/TLS* expression, whereas transfections with wild type *FUS/TLS* and the two mutants caused an increase in the *FUS/TLS* expression. Antibodies against *FUS/TLS* and the V5-tag were used (Materials and methods). See Appendix page 389 for Supplementary Figure 17.3 in color.



**Supplementary Figure 17.4** Correlation of RT-PCR with RNA-Seq data is shown for nucleolin (*NCL*) and eukaryotic translation elongation factor 2 (*EEF2*).

17



**Supplementary Figure 17.5** Correlation of RT-PCR with RNA-Seq data is shown for pre-mRNA-processing-splicing factor 8 (*PRPF8*).

# 18

**“Als inzicht ontstaat door ervaring, wie heeft er dan meer recht op zo’n eervolle kwalificatie: de wijze, die deels door schaamte en deels door zijn angstige karakter niets aanpakt, of de dwaas, die door geen schaamte – want die heeft hij niet – en door geen risico – want dat weegt hij niet – ooit wordt geremd?”**

Desiderius Erasmus, Lof der Zotheid.

# TDP-43 plasma levels: a biomarker for amyotrophic lateral sclerosis?

Esther Verstraete\*, H. Bea Kuiperij\*, Marka van Blitterswijk, Jan H. Veldink, Helenius J. Schelhaas, Leonard H. van den Berg#, Marcel M. Verbeek#

\* # Contributed equally to this work.

Submitted for publication.

## Abstract

**Objective:** TDP-43 has been identified as a major component of protein inclusions in the brains of patients with amyotrophic lateral sclerosis (ALS), and mutations in the corresponding gene (TAR DNA-binding protein [*TARDBP*]) have also been identified. Increased TDP-43 levels have been reported in the cerebrospinal fluid (CSF) of patients with ALS; however, plasma levels have not yet been assessed. We investigated TDP-43 plasma levels and examined a possible genotype-phenotype relation.

**Methods:** TDP-43 levels were quantified by sandwich ELISA in plasma of 219 patients and 100 controls. In addition, we sequenced exon six of *TARDBP*, and performed longitudinal TDP-43 plasma measures in a subset of patients.

**Results:** TDP-43 plasma levels were significantly increased in patients with ALS (p-value 0.023) compared to healthy controls, and showed a positive correlation with age at sampling. Longitudinal measures of TDP-43 plasma levels showed an increase in only one patient, with stable levels in five other patients. Three *TARDBP* mutations were identified in the ALS group (1.7%), but the association with TDP-43 plasma levels is ambiguous.

**Conclusions:** Our data indicate that TDP-43 plasma levels may have potential as biomarker in ALS. In addition, TDP-43 levels were found to increase with age, however, a genotype-phenotype relation could not be established in this cohort.

## Introduction

Amyotrophic lateral sclerosis (ALS) is a neurodegenerative disease characterized by the loss of motor neurons from the brain and spinal cord. Patients suffer from progressive muscle weakness, eventually leading to respiratory failure and death, on average, within three to five years.<sup>1</sup> Approximately one out of three patients with ALS develop behavioural and personality changes besides motor symptoms, 5-15% actually meets the criteria for frontotemporal dementia (FTD).<sup>2</sup> Vice versa, 10% of the patients with FTD will develop clinical or electrophysiological signs of motor neuron disease.<sup>3</sup> Taken together, there is an apparent clinical overlap between ALS and FTD.

A characteristic feature of degenerating motor neurons in ALS is the presence of cytoplasmic inclusions positive for ubiquitin. In 2006, the RNA processing protein TDP-43 was discovered to be the major component of these protein inclusions,<sup>4</sup> and therefore, characteristic for sporadic and most of the familial cases of ALS. Other proteins that have been found in these inclusions are superoxide dismutase-1 (SOD1) and fused in sarcoma / translated in liposarcoma (FUS/TLS).<sup>5</sup> The mechanisms leading to TDP-43 accumulation and neurodegeneration have not yet been elucidated. Mutations in the TAR DNA-binding protein (*TARDBP*), which encodes TDP-43, have been identified in a subset of patients with ALS and cerebral TDP-43 accumulation.<sup>6,7</sup> These mutations account for 4% of all familial and 1-5% of sporadic ALS cases. Most mutations have been detected in exon six of *TARDBP* and affect the C-terminal region of TDP-43, suggesting to affect normal protein-protein interactions.<sup>6</sup> TDP-43-positive protein inclusions have been detected in most cases of tau-negative FTD, providing pathological evidence for the clinical overlap between ALS and FTD.<sup>5</sup>

In patients with FTD, TDP-43 protein levels have been assessed in plasma by use of ELISA, showing increased levels in 46% of the patients with clinical FTD compared to 8% of the control subjects.<sup>8</sup> Nonetheless, pathological studies were unable to correlate these plasma levels of TDP-43 with either the presence or the amount of TDP-43 protein brain pathology.<sup>9</sup> As yet, the significance of increased TDP-43 in plasma needs to be elucidated.

A biochemical marker for the diagnosis and prognosis of ALS is currently lacking, but is urgently needed to shorten diagnostic delay and to optimize patient care. The TDP-43 protein, as a key player in ALS pathogenesis, is an obvious candidate marker.

We hypothesized that a subset of ALS patients would show increased TDP-43 plasma levels, in analogy to FTD patients. TDP-43 plasma levels were measured using ELISA, and cross-sectionally compared between patients with ALS and control subjects. In addition, longitudinal measures were performed in a subset of patients. As mutations in *TARDBP*

can cause ALS, we also screened ALS patients and control subjects for mutations in *TARDBP* and examined the association with TDP-43 plasma levels.

## Materials and methods

### Subjects

Plasma samples of 219 patients with ALS were studied and compared with 100 age- and gender-matched healthy control samples. All subjects gave written informed consent, in line with the Declaration of Helsinki, as approved by the medical ethics committee for research in humans of the University Medical Center Utrecht, The Netherlands. Patients were recruited from a national referral center for motor neuron disease, the University Medical Center Utrecht, and diagnosed with possible, probable or definite ALS according to the El Escorial criteria.<sup>30</sup> The demographic and key clinical features of the participants are outlined in Table 18.1.

Plasma was separated from whole blood samples (10 ml blood with EDTA acting as anti-coagulant) by routine methods, and stored at minus 80°C until the assay.

### Recombinant TDP-43 protein

The full open reading frame of human TDP-43 was obtained by PCR using an IMAGE clone as template and subcloned into the pET-46-EK/LIC system (Novagen, EMD chemicals, Darmstadt, Germany), introducing a N-terminal polyhistidine tag. The protein was expressed in *E. coli* BL21 (DE3) pLysS (Novagen), and purified using Ni-NTA agarose (Qiagen, Venlo, The Netherlands) according to the manufacturers instructions. The

**Table 18.1** Demographic and clinical characteristics of the patients and healthy subjects

|                       | Healthy control subjects (n = 100)<br>Mean ± SD (range) | ALS patients (n = 219)<br>Mean ± SD (range) |
|-----------------------|---|---|
| Age (y)               | 61.2 ± 10.4 (28-84)                                     | 62.6 ± 12.3 (24-89)                         |
| Male / Female         | 62 / 38   | 141 / 79                                    |
| Site of onset (n)     |   | Bulbar 67 (30%)<br>Spinal 153 (70%)         |
| Disease duration (m)* |   | 13.3 ± 1.2 (1-173)                          |

Abbreviations: y = years, n = number, m = months, SD = standard deviation, and ALS = amyotrophic lateral sclerosis.

\* At time of sampling.



protein concentration was determined by BCA protein assay (Pierce, Thermo Scientific, Rockford, Illinois, USA) and the purified protein (estimated purity > 90%) was used as a standard in the ELISA.

### TDP-43 ELISA

The ELISA for TDP-43 was performed essentially as described previously.<sup>8;11</sup> In brief, a mouse monoclonal antibody directed against TDP-43 (clone 2E2-D3, Abnova, Taipei City, Taiwan) was coated over night at 4°C in 0.1 M NaHCO<sub>3</sub> buffer pH 9.6, followed by blocking with 1% bovine serum albumin (BSA) in phosphate-buffered saline (PBS) during one hour at room temperature. Plasma and standard samples were incubated for two hours at 37°C, followed by incubation with a rabbit polyclonal antibody directed against TDP-43 (Proteintech Group, Manchester, UK) for one hour at 37°C. A goat anti-mouse horseradish peroxidase conjugated secondary antibody (Jackson ImmunoResearch Laboratories, Suffolk, UK) was incubated for one hour at 37°C, followed by detection of luminescence using SuperSignal ELISA femto maximum sensitivity substrate (Pierce, Thermo Scientific) and a Lumistar Optima instrument (BMG Labtech, Ortenberg, Germany).

### Sequencing exon six of *TARDBP*

A subset of ALS patients and control subjects was available for sequencing (175 and 83 cases respectively), and these subjects were screened for mutations in exon six of *TARDBP*.<sup>6;7</sup> Primers have been described previously.<sup>7</sup> We used BigDye Terminator 3.1 sequencing kit (Applied Biosystems, Foster City, California, USA) and a DNA Analyzer 3730XL for sequencing. Data analysis was performed with PolyPhred and identified mutations were confirmed on genomic DNA.<sup>12</sup> PMut was used to predict the impact of these mutations on the structure and function of TDP-43 (<http://mmb2.pcb.ub.es:8080/PMut/>).

### Statistical analysis

All data was analysed using the R software package for statistical computing (<http://www.R-project.org>, R Version 2.12-0 GUI 1.35); TDP-43 plasma levels were tested for normality with the Kolmogorov-Smirnov test. As the data was skewed, normality requirements were not met and log-transformation was performed. Subsequently, normality was reached and the difference between patients and healthy control subjects was assessed using a linear model, including covariables such as age, gender and disease duration (at the time of sampling).

## Results

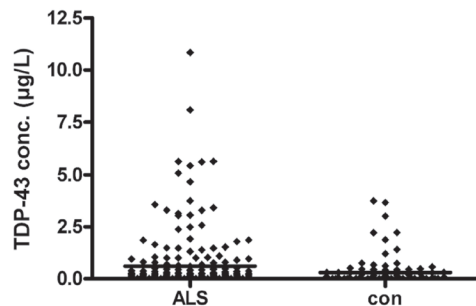
### TDP-43 concentration in plasma

TDP-43 levels were significantly increased in patients with ALS as compared to healthy control subjects ( $p$ -value 0.023; Figure 18.1). In 28% of ALS patients the absolute TDP-43 concentration was above the detection limit (0.31  $\mu\text{g/L}$ ; defined as two standard deviations above the mean background signal) versus 21% of the control subjects. It is important to note that whereas the highest measure in control subjects was 3.76  $\mu\text{g/L}$  it was up to 10.85  $\mu\text{g/L}$  in ALS patients.

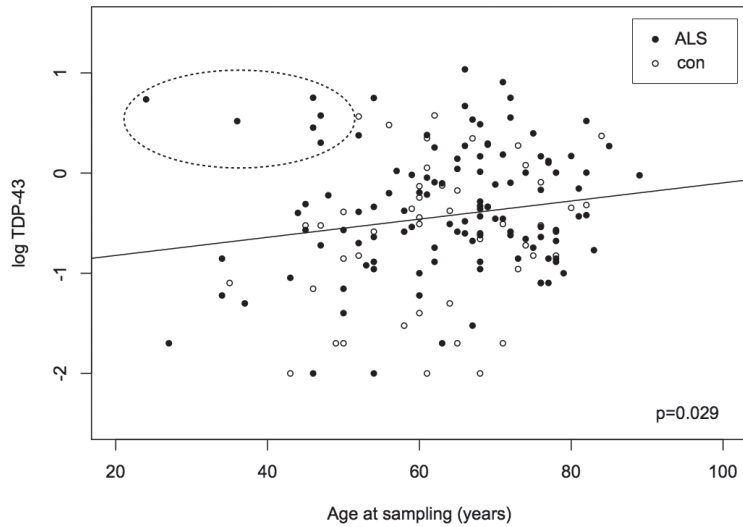
A linear model examining TDP-43 levels and age at sampling showed a significant positive correlation ( $p$ -value 0.029; Figure 18.2), but disease duration and gender were not related to TDP-43 levels (respectively  $p$ -value 0.53 and  $p$ -value 0.86; data not shown). Including both disease status (as factor) and age at sampling in a linear model was statistically significant (F-statistic;  $p$ -value 0.008).

### Longitudinal measures

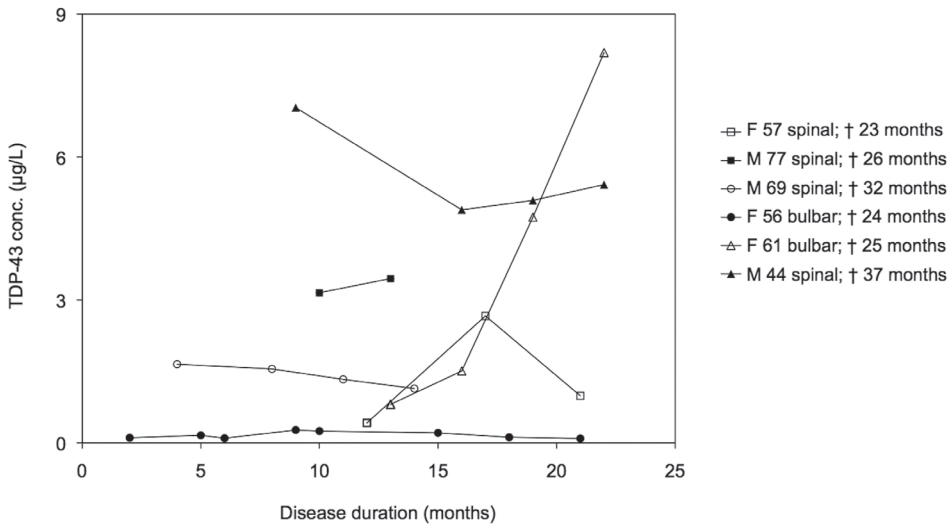
Samples, collected longitudinally at two to eight time points, were available from six patients. In five patients, the TDP-43 plasma levels were relatively consistent in time. However, in one patient, four consecutive measurements showed a marked increase over time (Figure 18.3). This particular subject was a 61-years-old female patient with a bulbar onset who died a few months after the last measurement. Other subjects who died during a similar follow-up did not show an increase in TDP-43 level. There was one other subject with bulbar onset, however, in this case TDP-43 plasma levels were not detectable.



**Figure 18.1** TDP-43 plasma levels in patients with ALS and healthy control subjects. TDP-43 protein levels were determined using ELISA in plasma of ALS patients and healthy controls (con). The horizontal bar indicates the mean TDP-43 level per group. TDP-43 levels are significantly increased in ALS plasma as compared to controls.



**Figure 18.2** Correlation between TDP-43 plasma levels and age at sampling for patients with ALS and control subjects (con). It is noticeable that a small number of relatively young patients have increased TDP-43 levels (encircled in plot).



**Figure 18.3** Longitudinal TDP-43 plasma measures. In six patients we performed two to eight longitudinal measures. This graph displays the TDP-43 plasma levels measured at different time points during the disease course. All patients were deceased at the time we analysed the data. The survival is indicated per subject in the legend. In five out of six patients these measures are relatively stable over time, except for one patient (F 61 bulbar) who had a rising plasma TDP-43 level. Abbreviations: Legend (gender (F = female; M = male); age of onset (years); site of onset (spinal/bulbar); survival (months)); TDP-43 conc. = TDP-43 plasma concentrations.

**Table 18.2** Clinical characteristics of patients with *TARDBP* variants. PMut was used to predict the impact of the identified variants on the function of TDP-43. The p.G295C and p.N352S variants were predicted to be pathogenic.

| Variant | PMut       | Group | Gender | Age at onset (y) | Site of onset | Survival (m) | TDP-43 plasma level (µg/L) |
|---------|------------|-------|--------|------------------|---------------|--------------|----------------------------|
| p.A315A | Silent     | SALS  | M      | 54               | Cervical      | >48*         | 0.00                       |
| p.G295C | Pathogenic | FALS  | F      | 80               | Bulbar        | 43           | 1.01                       |
| p.N352S | Pathogenic | SALS  | M      | 53               | Cervical      | 180          | 0.47                       |

Abbreviations: FALS = familial amyotrophic lateral sclerosis, and SALS = sporadic amyotrophic lateral sclerosis.

\* Alive at the time of data-analysis.

### TDP-43 genotyping

In the group of patients we identified three patients (1.7%) with a *TARDBP* mutation. In two of these patients we found a non-synonymous mutation in exon six of *TARDBP*, most likely pathogenic based on the PMut analysis. One patient had a silent mutation. The clinical characteristics of patients with *TARDBP* variants are displayed in Table 18.2. The two patients with a pathogenic mutation had a measurable TDP-43 concentration in plasma, respectively 0.47 and 1.01 µg/L.

## Discussion

In this study, we investigated whether TDP-43 plasma levels are a suitable biomarker for ALS, especially since nearly all ALS patients, apart from those with *FUS/TLS* or *SOD1* mutations, exhibit TDP-43 protein inclusions as pathological entity in the brain. We show that plasma TDP-43 levels were significantly increased in patients with ALS, compared to healthy control subjects. Furthermore, TDP-43 plasma levels positively correlated with age. In addition, we identified *TARDBP* mutations in three ALS patients, but these were not associated with TDP-43 protein levels in plasma. Longitudinally performed measurements appeared to be consistent over time except for one subject showing a marked increase with disease progression.

With the development of disease modifying therapies, an *in vivo* assessment of the type and extent of neuropathological changes in the brain (e.g. by means of a blood test) is of increasing importance and would facilitate diagnosis and drug discovery. Our finding of significantly increased TDP-43 levels in plasma might be related to the TDP-43 accumulation in the brain, and is supported by a positive relation with age.

In previous studies raised plasma TDP-43 levels have been found in FTD patients,<sup>8</sup> as well as patients with inclusion body myositis (IBM), an important mimic of ALS.<sup>33</sup> FTD patients had detectable TDP-43 levels in 46% of cases, which is a higher number than in our study (28% of ALS patients).<sup>8</sup> This could be due to minor technical differences in assay performance or more extensive protein accumulation in the brains of patients with FTD as compared to ALS. This difference could indicate that TDP-43 plasma levels correlate with neuropathological changes. However, a study in patients with FTD that focused on this issue did not confirm this hypothesis.<sup>9</sup> Similar studies in ALS are currently lacking, so the pathological correlate of elevated TDP-43 in plasma of patients with ALS needs to be established.

Previous studies in ALS have shown increased TDP-43 levels in cerebrospinal fluid (CSF).<sup>11;14;15</sup> One of these studies suggests that patients with a short disease duration (of up to ten months) have higher TDP-43 levels in CSF,<sup>11</sup> as compared to patients with longer disease duration. Another study suggested a relation between increased TDP-43 levels and longer survival.<sup>15</sup> In this study we could not confirm a relation between plasma TDP-43 and disease duration or survival. However, we observed an association of plasma TDP-43 with age.

The small subset of patients in which longitudinal measures were performed revealed stable levels over time in all but one patient. This particular subject did not have any specific characteristics compared to the other patients. The increase in TDP-43 protein levels was not a sign of impending death, since other patients also died within a similar follow-up and did not show increasing plasma TDP-43 levels. Nevertheless, this finding stresses the importance for future studies to include longitudinal analyses on a larger scale.

Mutational analysis of *TARDBP* revealed a mutation in three patients (1.7%), two of which were most likely pathogenic. This percentage is in accordance with previous studies on *TARDBP* gene mutations in sporadic ALS patients.<sup>6;7</sup> The numbers in this cohort are too small to establish a genotype-phenotype relation as was reported in studies on progranulin. Mutations in the progranulin gene (*PGRN*) cause FTD and were found related to plasma levels of progranulin protein.<sup>16</sup> In this context it is relevant to note that, despite overlapping pathological characteristics in ALS and FTD, both showing cerebral TDP-43 accumulation, mutations in *TARDBP* have been identified in only few cases of FTD without signs of motor neuron disease.<sup>17</sup> Taken together, a genetic mutation in *TARDBP* might be associated with an abnormal plasma concentration, however, vice versa an abnormal plasma concentration in most cases is not associated with a mutation in *TARDBP*.

We conclude from this study that patients with ALS, as a group, have significantly raised plasma levels of TDP-43 compared to healthy controls, and this finding could possibly be related to the cerebral accumulation of this protein. Based on analysis of the current small group of patients with *TARDBP* mutations, we did not find a correlation between TDP-43 plasma levels and these mutations. Future studies should include pathological assessments to find a potential correlation between TDP-43 plasma levels and cerebral protein accumulation. Finally, quantification of the pathological, phosphorylated form of TDP-43 in plasma may help to improve differentiation of ALS patients from healthy control subjects.

## Acknowledgements

We would like to thank Alexandra Versleijen for technical assistance. This research was supported by The Alzheimer's Drug Discovery Foundation, the Association for Frontotemporal Dementias and The Netherlands ALS Foundation.

## References

- (1) Logroscino G, Traynor BJ, Hardiman O, et al. Descriptive epidemiology of amyotrophic lateral sclerosis: new evidence and unsolved issues. *J Neurol Neurosurg Psychiatry* 2008;79:6-11.
- (2) Ringholz GM, Appel SH, Bradshaw M, Cooke NA, Mosnik DM, Schulz PE. Prevalence and patterns of cognitive impairment in sporadic ALS. *Neurology* 2005;65:586-590.
- (3) Lillo P, Garcin B, Hornberger M, Bak TH, Hodges JR. Neurobehavioral features in frontotemporal dementia with amyotrophic lateral sclerosis. *Arch Neurol* 2010;67:826-830.
- (4) Neumann M, Sampathu DM, Kwong LK, et al. Ubiquitinated TDP-43 in frontotemporal lobar degeneration and amyotrophic lateral sclerosis. *Science* 2006;314:130-133.
- (5) Mackenzie IR, Rademakers R, Neumann M. TDP-43 and FUS in amyotrophic lateral sclerosis and frontotemporal dementia. *Lancet Neurol* 2010;9:995-1007.
- (6) Kabashi E, Valdmanis PN, Dion P, et al. TARDBP mutations in individuals with sporadic and familial amyotrophic lateral sclerosis. *Nat Genet* 2008;40:572-574.
- (7) Sreedharan J, Blair IP, Tripathi VB, et al. TDP-43 mutations in familial and sporadic amyotrophic lateral sclerosis. *Science* 2008;319:1668-1672.
- (8) Foulds P, McAuley E, Gibbons L, et al. TDP-43 protein in plasma may index TDP-43 brain pathology in Alzheimer's disease and frontotemporal lobar degeneration. *Acta Neuropathol* 2008;116:141-146.

- (9) Foulds PG, Davidson Y, Mishra M, et al. Plasma phosphorylated-TDP-43 protein levels correlate with brain pathology in frontotemporal lobar degeneration. *Acta Neuropathol* 2009;118:647-658.
- (10) Brooks BR, Miller RG, Swash M, Munsat TL, World Federation of Neurology Research Group on Motor Neuron Diseases. El Escorial revisited: revised criteria for the diagnosis of amyotrophic lateral sclerosis. *Amyotroph Lateral Scler* 2000;1:293-299.
- (11) Kasai T, Tokuda T, Ishigami N, et al. Increased TDP-43 protein in cerebrospinal fluid of patients with amyotrophic lateral sclerosis. *Acta Neuropathol* 2009;117:55-62.
- (12) Nickerson DA, Tobe VO, Taylor SL. PolyPhred: automating the detection and genotyping of single nucleotide substitutions using fluorescence-based resequencing. *Nucleic Acids Res* 1997;25:2745-2751.
- (13) Kuiperij HB, Abdo WF, van Engelen BG, Schelhaas HJ, Verbeek MM. TDP-43 plasma levels do not differentiate sporadic inclusion body myositis from other inflammatory myopathies. *Acta Neuropathol* 2010;120:825-826.
- (14) Steinacker P, Hendrich C, Sperfeld AD, et al. TDP-43 in cerebrospinal fluid of patients with frontotemporal lobar degeneration and amyotrophic lateral sclerosis. *Arch Neurol* 2008;65:1481-1487.
- (15) Noto Y, Shibuya K, Sato Y, et al. Elevated CSF TDP-43 levels in amyotrophic lateral sclerosis: Specificity, sensitivity, and a possible prognostic value. *Amyotroph Lateral Scler* 2011;12:140-143.
- (16) Ghidoni R, Benussi L, Glionna M, Franzoni M, Binetti G. Low plasma progranulin levels predict progranulin mutations in frontotemporal lobar degeneration. *Neurology* 2008;71:1235-1239.
- (17) Borroni B, Archetti S, Del Bo R, et al. TARDBP mutations in frontotemporal lobar degeneration: frequency, clinical features, and disease course. *Rejuvenation Res* 2010;13:509-517.

# 19

**“De weg naar boven en naar beneden  
zijn één en dezelfde.”**

Herakleitos, Alles Stroomt.



# **Anti-superoxide dismutase antibodies are associated with survival in patients with sporadic amyotrophic lateral sclerosis**

Marka van Blitterswijk, Sunita Gulati, Elizabeth Smoot, Matthew Jaffa,  
Nancy Maher, Bradley T. Hyman, Adrian J. Ivins, Clemens R. Scherzer,  
David A. Schoenfeld, Merit E. Cudkowicz, Robert H. Brown Jr., Daryl A. Bosco

## Abstract

Our objective was to test the hypothesis that aberrantly modified forms of superoxide dismutase-1 (SOD<sub>1</sub>) influence the disease course for sporadic amyotrophic lateral sclerosis (SALS). We probed for anti-SOD<sub>1</sub> antibodies (IgM and IgG) against both the normal and aberrantly oxidized-SOD<sub>1</sub> (SOD<sub>ox</sub>) antigens in sera from patients with SALS, subjects diagnosed with other neurological disorders and healthy individuals, and correlated the levels of these antibodies to disease duration and/or severity. Anti-SOD<sub>1</sub> antibodies were detected in all cohorts; however, a subset of ~5–10% of SALS cases exhibited elevated levels of anti-SOD<sub>1</sub> antibodies. Those SALS cases with relatively high levels of IgM antibodies against SOD<sub>ox</sub> exhibit a longer survival of 6.4 years, compared to subjects lacking these antibodies. By contrast, SALS subjects expressing higher levels of IgG antibodies reactive for the normal WT-SOD<sub>1</sub> antigen exhibit a shorter survival of 4.1 years. Anti-SOD<sub>1</sub> antibody levels did not correlate with disease severity in either the Alzheimer's or Parkinson's disease cohorts. In conclusion, the association of longer survival with elevated levels of anti-SOD<sub>ox</sub> antibodies suggests that these antibodies may be protective. By extension, these data implicate aberrantly modified forms of WT-SOD<sub>1</sub> (e.g. oxidized SOD<sub>1</sub>) in SALS pathogenesis. In contrast, an immune response against the normal WT-SOD<sub>1</sub> appears to be disadvantageous in SALS, possibly because the anti-oxidizing activity of normal WT-SOD<sub>1</sub> is beneficial to SALS individuals.

## Introduction

Amyotrophic lateral sclerosis (ALS) is the most common motor neuron disease, marked by progressive degeneration of motor neurons.<sup>1</sup> Approximately 20–25% of familial ALS (FALS) cases are due to mutations in superoxide dismutase-1 (*SOD1*), of which more than 150 have been reported to date (<http://alsod.iop.kcl.ac.uk/index.aspx>). While 10% of ALS cases are classified as FALS, the vast majority of cases are sporadic in nature (SALS). Although FALS and SALS are clinically similar, the causative factors involved with SALS remain largely unknown.

An abundance of evidence supports the view that FALS-linked mutations alter the conformational stability of the *SOD1* protein and render it neurotoxic through mechanisms that involve misfolding,<sup>2,3</sup> mutant specific protein interactions,<sup>4</sup> and/or altered subcellular localization.<sup>5</sup> Recent studies suggest that similar cytotoxic mechanisms may be implicated in SALS as a consequence of adverse post-translational modifications of wild-type (WT) *SOD1*.<sup>6</sup> For example, using a monoclonal conformation-specific antibody (C4F6),<sup>7</sup> we showed that an oxidized form of WT-*SOD1* (*SODox*)<sup>8</sup> is conformationally similar to FALS-linked mutant *SOD1* proteins, and that aberrant WT-*SOD1* proteins are present in post mortem SALS spinal cord tissues.<sup>9</sup> Moreover, *SODox* and FALS-linked mutant *SOD1* proteins exert a similar toxic effect in an in vitro assay for fast-axonal transport.<sup>9,10</sup> These observations suggest that a common link between FALS and SALS is the presence of toxic variants of the *SOD1* protein, arising respectively from germline mutations and aberrant post-translational processing.

To further address the role of aberrantly modified WT-*SOD1* in SALS pathogenesis, we performed an ELISA for the detection of anti-*SOD1* antibodies against both normal WT-*SOD1* and *SODox*, and determined whether the levels of these anti-*SOD1* antibodies correlate with SALS patient survival. Although *SOD1* is normally an intracellular protein, data indicate that mutant *SOD1* interacts aberrantly with chromogranin proteins and is thereby secreted into the extracellular milieu where it is potentially accessible to the immune system.<sup>3</sup> Since modified forms of WT-*SOD1* (e.g. *SODox*) in SALS mimic mutant *SOD1* in FALS, we hypothesized that the modified WT-*SOD1* protein is also secreted, and that SALS individuals may generate antibodies against the modified protein. If the putative antibodies reduce the level and toxicity of the offending modified WT-*SOD1*, then the antibody levels are expected to correlate with phenotypic features of the disease. That these antibodies could be neuroprotective is suggested by immunization and immunotherapy studies in ALS mouse models,<sup>7,11</sup> including a recent report demonstrating a neuroprotective effect in *SOD1*<sup>G93A</sup> transgenic mice that were vaccinated with misfolded WT-apo *SOD1*.<sup>12</sup>

## Materials and methods

### Human subjects

Sera from 298 ALS patients with probable or definite sporadic ALS according to revised El Escorial criteria, were obtained from the Clinical Trials Unit, Massachusetts General Hospital (MGH, Table 19.1). MGH also provided sera from 61 healthy controls (HC) and thirteen disease controls with neurological disorders (OND) other than ALS. Additionally, the sera for fifty individuals with a definite diagnosis of Alzheimer's disease (AD), fifty patients with Parkinson's disease (PD) and fifty age-matched HC from the Harvard NeuroDiscovery Center Biomarker Study, Brigham and Women's Hospital, Cambridge, MA, USA (HBS, Table 19.4) were obtained. All subjects signed an informed consent. More information is provided in the Supplementary Materials and methods.

### Production of SOD1 antigens

WT-SOD<sub>1</sub> was expressed as a glutathione-S-transferase (GST)-fusion protein in *Escherichia coli* as described.<sup>13</sup> GST-SOD<sub>1</sub> was purified with glutathione-agarose (Sigma) according to the manufacturer's instructions. Cleavage of the GST tag was accomplished with the PreScission Protease (GE Healthcare Life Sciences), and glutathione-agarose was subsequently employed to remove the protease and cleaved GST. Q-sepharose fast-flow was used as the final step in the purification of WT-SOD<sub>1</sub> as described.<sup>14</sup> Recombinant SODox was then prepared from purified WT-SOD<sub>1</sub> as described.<sup>9</sup>

**Table 19.1** Demographic characteristics of the study subjects from Massachusetts General Hospital

|                                      | SALS                          | Healthy controls | Other neurological diseases |
|--------------------------------------|-------------------------------|------------------|-----------------------------|
| Number of subjects <sup>a</sup>      | 298                           | 61               | 13                          |
| Ratio white/other (%)                | 92/8                          | 97/3             | 85/15                       |
| Ratio male/female (%)                | <b>38/62<sup>b</sup></b>      | 62/38            | 54/46                       |
| Age of collection (mean years, ± SE) | <b>56.6 ± 3.5<sup>c</sup></b> | 47.3 ± 1.7       | 50.9 ± 4.0                  |

Abbreviations: SE = standard error, and SALS = sporadic amyotrophic lateral sclerosis.

<sup>a</sup> Sera samples for all subjects reported in this table were obtained through the Clinical Trials Unit at Massachusetts General Hospital (Methods).

<sup>b</sup> The difference in male/female ratio between the SALS and healthy control cohorts is statistically significant (p-value 0.0005) as determined by the Chi-square test.

<sup>c</sup> The difference in mean age of serum sample collection (years) between the SALS and healthy control cohorts is statistically significant (p-value < 0.0001) as determined by the Wilcoxon Z-test.

<sup>b,c</sup> Statistically significant differences between cohorts are highlighted in bold.

## ELISA

Immulux medium binding flat bottom plates (Dyner Technologies, USA) were coated (50  $\mu\text{L}$ /well) with 5  $\mu\text{g}/\text{ml}$  WT-SOD1 or SODox in  $\text{NaCO}_3$  buffer (pH 9.6).<sup>15</sup> Coated plates were incubated for three hours at 37°C, after which they were stored at 4°C overnight, and then washed in 0.01 M phosphate-buffered saline (PBS, pH 7.4) with 0.05% Tween-20 (polysorbant-20, Fisher Scientific) (PBS-T) for one hour to block the non-specific binding.<sup>16</sup> Serial dilution of human serum was prepared in PBS-T and 50  $\mu\text{L}$  of the diluted serum was added to SOD-WT or SODox-coated wells. The remainder of the assay was performed as described.<sup>17-20</sup> A detailed description is given in the Supplementary Materials and methods.

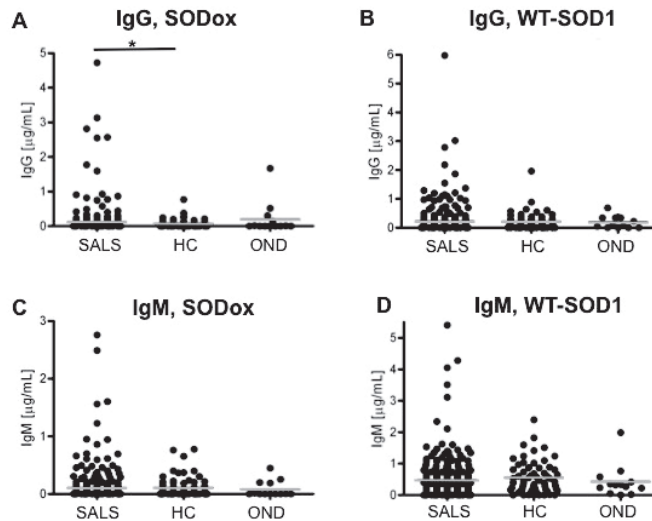
## Statistical analysis

All statistical tests used in this study are listed in the tables and figures. Parametric methods were used in the analyses where distributional assumptions were met, using the SAS Statistical Package (SAS Institute Inc., V9.1). Where normality, variance, or sample size requirements were not met, comparable non-parametric methods available in SAS, the StatXact Statistical Package,<sup>21</sup> or GraphPad Prism software were employed. For all analyses, p-values below 0.05 were considered significant. More information can be found in the Supplementary Materials and methods.

## Results

### Anti-SODox IgG antibodies are elevated in SALS

The first ELISA screen quantified anti-SOD1 antibodies against the normal WT-SOD1 and aberrantly oxidized SOD1 (SODox)<sup>8,9</sup> antigens in sera obtained through the MGH Clinical Trial Unit (Table 19.1 and Methods). WT-SOD1 and SODox were used to probe levels of IgM antibodies, which are generated during the primary antibody response upon acute exposure to antigens, as well as IgG antibodies that are produced during the secondary antibody response.<sup>22</sup> Anti-SOD1 antibodies were detected in all three cohorts (Figure 19.1, Table 19.2), and those cases with the highest concentrations of anti-SOD1 antibodies tested were consistently within the SALS cohort (Figure 19.1). Mean levels of anti-SODox IgG antibodies are significantly higher in SALS patient sera (0.11  $\mu\text{g}/\text{ml}$ ) compared to healthy controls (0.07  $\mu\text{g}/\text{ml}$ ; p-value 0.03), with approximately 5–10% of subjects from the SALS cohort exhibiting anti-SODox IgG levels above those detected in the HC and OND cohorts.



**Figure 19.1** Serum antibody levels are elevated in SALS cases compared to healthy controls (HC) and subjects with other neurological disorders (OND). Sera samples for all subjects reported in this figure were obtained through the Clinical Trials Unit at Massachusetts General Hospital (Methods). Sera concentrations ( $\mu\text{g}/\text{ml}$ ) of IgG antibodies against the SODox antigen (A) and WT-SOD1 antigen (B), and concentrations of IgM antibodies against the SODox antigen (C) and WT-SOD1 antigen (D), are shown in a dot-graph representation for the SALS, HC and OND cohorts. Each dot denotes the antibody concentration for a single subject; multiple subjects with the same concentration are represented by horizontal rows of dots. Mean antibody concentrations (Table 19.2) for the specified cohort are represented by gray bars. \*Mean levels of anti-SODox IgG antibodies are significantly higher in SALS patient sera ( $0.11 \mu\text{g}/\text{ml}$ ) compared to controls ( $0.07 \mu\text{g}/\text{ml}$ ,  $p$ -value 0.03).

We were able to detect SOD1 antigens by a western blot analysis, but only under native (non-denaturing) conditions (data not shown). Under native conditions the specific three-dimensional segment of the SOD1 antigen that is recognized by the antibody (conformational epitope) is conserved, as opposed to a denaturing western blot analysis that disrupts this conformation and only allows recognition of linear sequences. Thus, our findings indicate that human anti-SOD1 antibodies in these cases are reactive for a conformational epitope of SOD1. Native western blot analysis are inherently insensitive and the biological samples employed here were limited, and thus, only those serum samples with the highest levels of anti-SOD1 antibodies were able to detect SOD1 antigens by a native western blot analysis (data not shown).

We subjected a subset ( $n = 7$ ) of cerebrospinal fluid (CSF) samples to our ELISA, and included CSF from individuals who exhibited relatively high levels of serum anti-SOD1

**Table 19.2** Mean serum anti-SOD1 antibody concentrations for SALS, healthy control and other neurological disease cohorts

| Cohort <sup>a</sup>          | IgG, SODox                     |        | IgG, WT-SOD1 |        | IgM, SODox  |        | IgM, WT-SOD1 |        |
|------------------------------|--------------------------------|--------|--------------|--------|-------------|--------|--------------|--------|
|                              | µg/ml ± SE                     | Number | µg/ml ± SE   | Number | µg/ml ± SE  | Number | µg/ml ± SE   | Number |
| SALS                         | <b>0.11 ± 0.03<sup>b</sup></b> | 298    | 0.23 ± 0.03  | 298    | 0.11 ± 0.02 | 298    | 0.48 ± 0.04  | 298    |
| Healthy controls             | 0.07 ± 0.02                    | 61     | 0.22 ± 0.04  | 61     | 0.11 ± 0.02 | 61     | 0.55 ± 0.07  | 61     |
| Other neurological disorders | 0.20 ± 0.13                    | 13     | 0.19 ± 0.06  | 13     | 0.08 ± 0.04 | 13     | 0.43 ± 0.14  | 13     |

<sup>a</sup> Sera samples for all subjects reported in this table were obtained through the Clinical Trials Unit at Massachusetts General Hospital (Methods).

<sup>b</sup> The difference in mean levels of anti-SODox IgG antibodies between SALS and healthy control cohorts is statistically significant (p-value 0.03), which is indicated by the bold font, as determined by the Wilcoxon Z-test; the Bonferroni correction requires an  $\alpha=0.05/\beta=0.0167$  for statistical significance for this comparison.

antibodies. Anti-SOD1 antibodies were not detected in any of our CSF samples (data not shown). Since antibody levels in CSF are approximately 1000-fold lower than in human serum,<sup>23</sup> it is likely that potential anti-SOD1 antibodies in our CSF samples are below the limit of detection of our ELISA.

Demographic analyses confirmed that race and gender are not confounders for the mean anti-SOD1 antibody levels (Table 19.1, Supplementary Tables 19.1, 19.2). Although the mean age for sera-sample collection is higher for the SALS compared to HC cohort (Table 19.1), this difference is not a confounder for the elevated levels of anti-SOD1 IgG detected in SALS because these antibody levels do not correlate with age of collection (Supplementary Table 19.2).

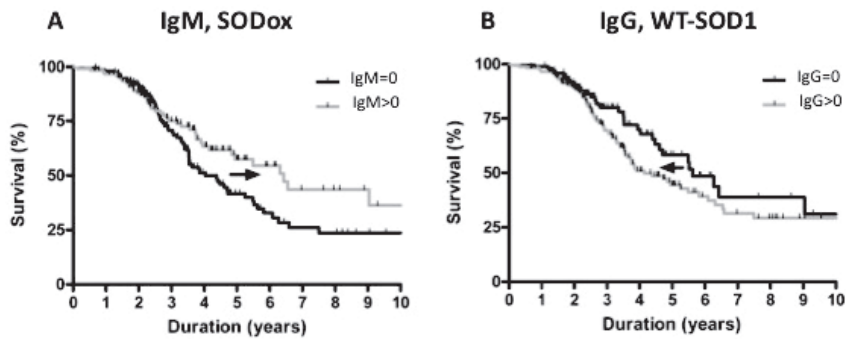
Moreover, in the healthy controls cohort, anti-SOD1 antibody levels do not correlate with age of collection. For the SALS cohort, we have also analyzed the interval between age of collection and onset of symptoms. The mean interval between these time-points was 2.1 years ( $\pm 0.11$ ) and no correlation with the antibody level was detected.

### Anti-SOD antibodies levels predict survival

For those SALS subjects with detectable levels of anti-SOD1 antibodies, we sought to determine whether their antibody levels have an impact on the SALS disease course. First, we investigated whether anti-SOD1 antibody levels correlate with SALS disease duration (survival). The 153 (55%) SALS subjects that expressed SOD1 IgM antibodies (IgM > 0) were compared to the 127 (45%) SALS subjects without SOD1 IgM antibodies (IgM = 0) for which survival data were available, and the survival analysis (Figure 19.2A) revealed that subjects expressing SOD1 IgM antibodies have a longer survival of 6.4 years (confidence interval [CI] 4.1–12.5) compared to those SALS subjects without SOD1 IgM antibodies, who have a mean survival of only 4.0 years (CI 3.5–5.5). This 2.4-year difference results in a hazard ratio of 1.3, and indicates that higher IgM SOD1 antibody levels may confer a survival advantage.

In contrast, there is an inverse correlation between survival and WT-SOD1 IgG antibody levels. The 182 (65%) SALS subjects expressing WT-SOD1 IgG antibodies (IgG > 0) exhibit significantly shorter survivals than the 97 (35%) SALS subjects who lack WT-SOD1 IgG antibodies (IgG = 0). The median survival for SALS patients without WT-SOD1 IgG antibodies is 5.6 years (CI 4.5–16.0), whereas survival is only 4.1 years (CI 3.6–5.8) for subjects with WT-SOD1 IgG antibodies (Figure 19.2B). This 1.5-year difference in the mean survival corresponds to a hazard ratio of 0.6, and suggests that antibodies against the normal, WT-SOD1 protein may be disadvantageous to individuals with SALS.





**Figure 19.2** Anti-SOD1 antibody levels predict disease duration in the SALS cohort. Sera samples for all subjects reported in this figure were obtained through the Clinical Trials Unit at Massachusetts General Hospital (Methods). (A) SALS subjects with SODox IgM antibodies (IgM >0; n = 153) exhibit significantly longer median survival (6.4 years; confidence interval [CI] 4.1–12.5; gray curve) compared to subjects without SODox IgM antibodies (IgM = 0; n = 127) (median survival 4.0 years; CI 3.5–5.5; black curve). The parameter corresponding with IgM rank in a Cox proportional hazards model of survival had a p-value of 0.05. (B) SALS subjects with WT-SOD1 IgG antibodies (IgG >0; n = 182) exhibit significantly shorter median survival (4.1 years; CI 3.6–5.8; gray curve) compared to subjects without WT-SOD1 IgG antibodies (IgG = 0; n = 97) (median survival 5.6 years; CI 4.5–16; black curve). The parameter corresponding with IgG rank in a Cox proportional hazards model of survival had a p-value of 0.04. The p-value remained significant when age was included in the model. (A,B) Black arrows indicate the impact of elevated anti-WT SOD1 IgG or anti-SODox IgM antibody levels on survival.

We note the difference in antibody isotype (IgM versus IgG) for the aforementioned antibodies. An analysis of IgM versus IgG antibody levels revealed an inverse correlation between anti-SODox IgM and IgG antibodies (Spearman's rank =  $-0.46$ , p-value <  $0.0001$ ), and between WT-SOD1 IgM and IgG antibodies (Spearman's rank =  $-0.13$ , p-value  $0.02$ ). Thus, SALS individuals express elevated levels either of anti-SOD1 IgM or IgG antibodies, but rarely elevated levels of both antibody isotypes. The differential expression of anti-SOD1 IgM and IgG antibodies suggests that the immune repertoires of these SALS patients are bimodal, exhibiting either predominantly primary (IgM) or secondary (IgG) responses to SOD1 antigens.

### Correlation of anti-SOD1 antibodies with age and site of SALS onset

Subsequently, we evaluated additional clinical features, including age of disease onset and site of onset, for SALS individuals expressing anti-SOD1 antibodies (IgG, IgM > 0) compared to individuals lacking these antibodies (IgG, IgM = 0). There was no significant difference in age of onset or site of onset for SALS individuals expressing anti-SODox and WT-SOD1 IgM antibodies compared to individuals lacking these antibodies (Table 19.3).

Sera samples containing anti-SODox and WT-SOD1 IgG antibodies corresponded to a mean age of onset of  $55.8 \pm 1.0$  and  $56.2 \pm 0.9$  years, respectively, whereas the respective mean age of onset for individuals lacking these antibodies was  $52.1 \pm 1.1$  and  $51.1 \pm 1.3$  years (Table 19.3). The age of onset for these four groups is similar to the mean age of onset (55 years) for this disease,<sup>24</sup> and thus, it is unlikely that the age differences alone could make a significant impact on the disease course. There were no significant differences for site of onset between groups expressing anti-SOD1 IgG antibodies and those that do not (Table 19.3).

### Anti-SOD1 antibodies do not correlate with disease severity for OND

The small sample size and heterogeneous nature of the initial OND cohort precluded us from evaluating whether anti-SOD1 antibodies are significantly elevated in non-ALS cases. Therefore, a second ELISA screen was performed with sera from fifty AD, fifty PD, and fifty HC cohorts, obtained through the HBS (Methods and Table 19.4). A separate HC cohort was screened to account for potential differences in sample handling/storage between the MGH and HBS facilities. Anti-SOD1 antibodies were detected in all HBS cohorts (Table 19.5 and Supplementary Figure 19.1) as observed for the MGH cohorts

**Table 19.3** Clinical parameters for the SALS cohort as a function of anti-SOD1 antibody levels

|                   |                 | Mean age of onset <sup>b</sup>      |            |            |     | Site of onset <sup>c</sup> |     |                     |     |
|-------------------|-----------------|-------------------------------------|------------|------------|-----|----------------------------|-----|---------------------|-----|
|                   |                 | Ab>0                                |            | Ab = 0     |     | Ab>0                       |     | Ab = 0              |     |
| Antibody          |                 | Years                               | n          | Years      | n   | % limb/<br>% bulbar        | n   | % limb/<br>% bulbar | n   |
| SALS <sup>a</sup> | IgG,<br>SODox   | <b>55.8 ± 1.0</b><br><b>(0.01)</b>  | <b>189</b> | 52.1 ± 1.1 | 106 | 72/28                      | 86  | 81/19               | 204 |
|                   | IgG,<br>WT-SOD1 | <b>56.2 ± 0.9</b><br><b>(0.001)</b> | <b>196</b> | 51.1 ± 1.3 | 99  | 78/22                      | 194 | 76/20               | 96  |
|                   | IgM,<br>SODox   | 53.4 ± 1.1                          | 136        | 55.4 ± 1.0 | 159 | 82/18                      | 131 | 75/24               | 159 |
|                   | IgM,<br>WT-SOD1 | 54.1 ± 0.7                          | 272        | 59.1 ± 3.4 | 23  | 79/21                      | 267 | 70/30               | 23  |

Abbreviation: Ab = antibodies.

<sup>a</sup> Sera samples for all subjects reported in this table were obtained through the Clinical Trials Unit at Massachusetts General Hospital (Methods).

<sup>b</sup> The mean age of onset is compared between SALS patients expressing the indicated antibody and SALS-patients without detectable antibodies.

<sup>c</sup> The ratio of limb/bulbar onset is compared between SALS-patients with- and without detectable antibodies.

<sup>b,c</sup> The Wilcoxon Z-test was used to determine statistically significant differences in mean age; for differences in site of onset a Fisher's exact test was used. Significant comparisons are highlighted in bold, and the corresponding p-values are shown in parentheses within the 'Ab>0' column.

(Figure 19.1, Table 19.2). The mean level of anti-SOD $\alpha$  IgG antibodies is higher in PD patient sera (0.09  $\mu$ g/ml) compared to HC (0.04  $\mu$ g/ml, p-value 0.02; Table 19.5). However, this statistical significance is dependent upon one case (IgG = 3.8  $\mu$ g/ml; Supplementary Figure 19.1) and is not statistically significant after a Bonferroni correction (Table 19.5).

When we combined data from both ELISA screens, we observed that cases with the highest (top 10%) anti-SOD $\alpha$  antibodies are consistently within the SALS cohort (n = 298) relative to all other cohorts (n = 224) (Supplementary Figure 19.2 and Supplementary Table 19.3).

In contrast to the correlations observed between SALS survival and anti-SOD $\alpha$  antibodies (Figure 19.2), there are no statistically significant correlations between anti-SOD $\alpha$  antibodies and AD or PD disease severity, as measured by the Mini Mental State Exam (MMSE) and the lower Unified Parkinson's Disease Rating Scale (UPDRS), respectively. Therefore, the clinical impact of anti-SOD $\alpha$  antibodies is more relevant to SALS survival than to the disease severity measures of other neurodegenerative diseases.

## Discussion

### Aberrant WT-SOD1 is associated with SALS

SOD $\alpha$  mutations acquired through Mendelian inheritance play an unequivocal role in SALS pathogenesis, and recent lines of evidence suggest an analogous role for WT-SOD $\alpha$  in the more common SALS. In vitro studies document that aberrant post-translational modifications to the WT-SOD $\alpha$  proteins, including oxidation,<sup>8,9,25</sup> de-metallation,<sup>26,27</sup> disulfide reduction,<sup>28</sup> and loss of dimer-subunit integrity<sup>29</sup> can induce the WT-SOD $\alpha$  protein to acquire mutant-like properties. Moreover, misfolded WT-SOD $\alpha$  has been detected in post mortem human SALS spinal cord tissues by immunohistochemistry.<sup>5,9</sup> Vaccination

**Table 19.4** Demographic characteristics of the study subjects from the Harvard NeuroDiscovery Center

|  | Alzheimer's disease | Parkinson's disease | Healthy controls |
|--|---------------------|---------------------|------------------|
| Number of subjects <sup>a</sup>          | 50                  | 50                  | 50               |
| Ratio male/female (%)                    | 54/46               | 54/46               | 54/46            |
| Age of collection (mean years, $\pm$ SE) | 74.8 $\pm$ 1.1      | 74.6 $\pm$ 1.1      | 74.6 $\pm$ 1.1   |

<sup>a</sup> Sera samples for all subjects reported in this table were obtained through the Harvard NeuroDiscovery Center (Methods). There is no significant difference in male/female ratio or mean age of serum sample collection (years) between subjects with Alzheimer's disease, Parkinson's disease or healthy controls, as determined by Chi-square test and the Wilcoxon Z-test respectively.

**Table 19.5** Mean serum anti-SOD1 antibody concentrations for Alzheimer's disease, Parkinson's disease, and healthy control cohorts

| Cohort <sup>a</sup> | IgG, SODox                     |        | IgG, WT-SOD1 |        | IgM, SODox  |        | IgM, WT-SOD1 |        |
|---------------------|--------------------------------|--------|--------------|--------|-------------|--------|--------------|--------|
|                     | µg/ml ± SE                     | Number | µg/ml ± SE   | Number | µg/ml ± SE  | Number | µg/ml ± SE   | Number |
| Alzheimer's disease | 0.06 ± 0.03                    | 50     | 0.20 ± 0.08  | 50     | 0.05 ± 0.02 | 50     | 0.13 ± 0.04  | 50     |
| Parkinson's disease | <b>0.09 ± 0.07<sup>b</sup></b> | 50     | 0.16 ± 0.07  | 50     | 0.10 ± 0.04 | 50     | 0.16 ± 0.05  | 50     |
| Healthy controls    | 0.04 ± 0.01                    | 50     | 0.13 ± 0.03  | 50     | 0.12 ± 0.04 | 50     | 0.20 ± 0.05  | 50     |

<sup>a</sup> Sera samples for all subjects reported in this table were obtained through the Harvard NeuroDiscovery Center (Methods).

<sup>b</sup> This comparison is significant (denoted by bold font) with the Wilcoxon Z-test (p-value 0.024), but not after Bonferroni correction, which requires an  $\alpha=0.05/3=0.0167$ .

against WT-apo SOD<sub>1</sub> has been shown to reduce the load and toxic effects of FALS-linked SOD<sub>1</sub><sup>G93A</sup> in the respective transgenic ALS mouse model,<sup>12</sup> further demonstrating that modified WT- and mutant-SOD<sub>1</sub> proteins share a similar ‘toxic’ conformation.

Our ELISA screen revealed that the mean levels of anti-SODox IgG antibodies are significantly higher in SALS patient sera (Table 19.2). We note that while the significance of this result is diminished with a Bonferonni correction, the correlations between anti-SODox antibodies and SALS both in Figure 19.1 and the survival analysis (discussed below) provide cumulative evidence that implicate modified WT-SOD<sub>1</sub> species in SALS pathogenesis. That anti-SOD<sub>1</sub> antibodies are not detected in all SALS samples suggests that modified WT-SOD<sub>1</sub> may be involved in a subset of SALS cases, consistent with previous immunohistochemical results.<sup>9</sup>

### Anti-SOD<sub>1</sub> antibody production and antibody isotypes

Since SOD<sub>1</sub> is intracellular, it is somewhat surprising a priori that the immune system should mount a response to this protein. At least three factors may be important in this regard. First, it is conceivable that the process of cell death simply releases the SOD<sub>1</sub> protein within the CNS, which would account for the presence of anti-SOD<sub>1</sub> antibodies in healthy control cohorts, as well as in the disease (SALS and OND) cohorts. Secondly, recent data indicate that SOD<sub>1</sub> is actively secreted.<sup>30,31</sup> The neurosecretory chromogranin proteins promote the selective secretion of mutant SOD<sub>1</sub> over WT-SOD<sub>1</sub> in cultured cells.<sup>3</sup> In light of the observation that SODox mimics FALS-linked SOD<sub>1</sub> mutants,<sup>8,9</sup> enhanced secretion of SODox or other modified WT-SOD<sub>1</sub> species by chromogranins may explain the elevated levels of anti-SODox IgG antibodies detected in our SALS cohort (Table 19.2). Finally, a third factor that may contribute to the genesis of anti-SOD<sub>1</sub> antibodies is neurodegenerative disease-dependent loss of integrity of the blood-brain and blood-spinal cord barriers, which has been documented in ALS mouse models.<sup>32</sup>

Given that there appears to be a robust humoral immune response to SOD<sub>1</sub> in ALS, can we understand the patterns of immunoglobulin isotypes that we detect? Our ELISAs reveal that SALS subjects differentially express IgG and IgM anti-SOD<sub>1</sub> antibodies, indicative of an isotype class-switch. In addition, younger SALS subjects express higher levels of anti-SOD<sub>1</sub> IgM antibodies, whereas older subjects express higher levels of anti-SOD<sub>1</sub> IgG antibodies (Supplementary Table 19.2).

A longitudinal study, like that reported by Zhang et al.,<sup>33</sup> is needed to further address the possibility that the differential expression of IgM and IgG antibodies reflects early and late stages, respectively, of a SALS immune response to SOD<sub>1</sub>.

## The impact of anti-SOD1 antibodies on disease course

Anti-SOD1 antibodies can potentially play a therapeutic or pathogenic role in SALS. Both active and passive immunization with the recombinant SOD1 antigens have delayed disease onset and/or prolonged survival in ALS mouse models.<sup>7,12</sup> Intracerebroventricular infusion of monoclonal anti-SOD1 antibodies also prolongs the lifespan of ALS mice.<sup>11</sup> These studies support a therapeutic role for anti-SOD1 antibodies. By contrast, several reports have described aberrant accumulation<sup>34,35</sup> and toxicity of IgG isolated from SALS samples. For instance, purified human ALS IgG is toxic to neural cells in culture,<sup>36,37</sup> and induces profound ultrastructural changes to spinal motor neurons when injected into mice.<sup>38</sup>

Our results are consistent with the view that some categories of anti-SOD1 antibodies may attenuate the rate of progression of ALS. Specifically, SALS subjects with anti-SODox IgM antibodies survive longer than subjects lacking these antibodies (Figure 19.2A). A possible mechanism for this beneficial influence is that anti-SODox IgM antibodies reduce SODox levels in the CNS, which in turn permits longer survival, reminiscent of the studies by Urushutani et al.<sup>7</sup> Therefore, the correlation between anti-SODox antibodies and prolonged survival further supports the hypothesis that aberrant WT-SOD1 proteins exhibit toxicity in SALS pathogenesis. In contrast, WT-SOD1 IgG antibody levels correlate with reduced survival for the SALS cohort (Figure 19.2B). By analogy, it may be disadvantageous to reduce levels of WT-SOD1, which may play a role in ameliorating the high levels of oxidative stress associated with SALS.<sup>39</sup>

## The role of anti-SOD1 antibodies: SALS versus non-SALS

An important issue in understanding the biological significance of the anti-SOD1 antibodies we have detected is their specificity. Our data clearly show that anti-SOD1 antibodies are present in subjects with other neurological diseases, and to a lesser extent in healthy control subjects. While anti-SOD1 antibodies correlate with SALS survival, they do not appear to impact disease severity measures associated with AD and PD. The results of our study indicate that the influence of anti-SOD1 antibodies may be more significant to ALS than other neurodegenerative diseases.

## Conclusion

We found that auto-antibodies against an aberrant form of SODox are associated with SALS, and that levels of anti-SOD1 antibodies correlate with ALS disease duration. These findings have important therapeutic implications in light of the observations

that aberrant WT-SOD<sub>1</sub> proteins are associated with SALS pathogenesis, and that immunotherapeutic approaches against aberrant SOD<sub>1</sub> proteins exhibit beneficial effects in mice. Therefore, it may be possible to implement immunotherapeutic strategies against misfolded SOD<sub>1</sub> for both SALS and FALS.

## Acknowledgements

We thank Anne Hunt and the Eunice Kennedy Shriver Center at the University of Massachusetts Medical School (UMMS) for statistical analyses, the UMMS Proteomic and Mass spectrometry Core facility at UMMS, the Northeast ALS Consortium and the Neurology Clinical Trial Unit for contributing sera samples. We acknowledge financial support from the ALS Therapy Alliance-CVS Pharmacy (D.A.B.), the ALS Association (D.A.B., and R.H.B. Jr), the US National Institutes of Health (D.A.B. (National Institute on Neurological Disorders and Stroke)), R.H.B. Jr (National Institute on Neurological Disorders and Stroke), the Angel Fund (R.H.B. Jr) and Project ALS (R.H.B. Jr).

## References

- (1) Bruijn LI, Houseweart MK, Kato S et al. Aggregation and motor neuron toxicity of an ALS-linked SOD<sub>1</sub> mutant independent from wild-type SOD<sub>1</sub>. *Science* 1998 Sep 18;281(5384):1851-1854.
- (2) Chattopadhyay M, Valentine JS. Aggregation of Copper-Zinc Superoxide Dismutase in Familial and Sporadic ALS. *Antioxid Redox Signal* 2009;11:1603-1614.
- (3) Urushitani M, Sik A, Sakurai T, Nukina N, Takahashi R, Julien JP. Chromogranin-mediated secretion of mutant superoxide dismutase proteins linked to amyotrophic lateral sclerosis. *Nat Neurosci* 2006;9:108-118.
- (4) Magrane J, Hervias I, Henning MS, Damiano M, Kawamata H, Manfredi G. Mutant SOD<sub>1</sub> in neuronal mitochondria causes toxicity and mitochondrial dynamics abnormalities. *Hum Mol Genet* 2009;18:4552-4564.
- (5) Forsberg K, Jonsson PA, Andersen PM et al. Novel antibodies reveal inclusions containing non-native SOD<sub>1</sub> in sporadic ALS patients. *PLoS One* 2010;5:e11552.
- (6) Gruzman A, Wood WL, Alpert E et al. Common molecular signature in SOD<sub>1</sub> for both sporadic and familial amyotrophic lateral sclerosis. *Proc Natl Acad Sci USA* 2007;104:12524-12529.
- (7) Urushitani M, Ezzi SA, Julien JP. Therapeutic effects of immunization with mutant superoxide dismutase in mice models of amyotrophic lateral sclerosis. *Proc Natl Acad Sci USA* 2007;104:2495-2500.

- (8) Ezzi SA, Urushitani M, Julien JP. Wild-type superoxide dismutase acquires binding and toxic properties of ALS-linked mutant forms through oxidation. *J Neurochem* 2007;102:170-178.
- (9) Bosco DA, Morfini G, Karabacak NM et al. Wild-type and mutant SOD1 share an aberrant conformation and a common pathogenic pathway in ALS. *Nat Neurosci* 2010;13:1396-1403.
- (10) Morfini GA, Burns M, Binder LI et al. Axonal transport defects in neurodegenerative diseases. *J Neurosci* 2009;29:12776-12786.
- (11) Gros-Louis F, Soucy G, Lariviere R, Julien JP. Intracerebroventricular infusion of monoclonal antibody or its derived Fab fragment against misfolded forms of SOD1 mutant delays mortality in a mouse model of ALS. *J Neurochem* 2010;113:1188-1199.
- (12) Takeuchi S, Fujiwara N, Ido A et al. Induction of protective immunity by vaccination with wild-type apo superoxide dismutase 1 in mutant SOD1 transgenic mice. *J Neuropathol Exp Neurol* 2010;69:1044-1056.
- (13) Ray SS, Nowak RJ, Strokovich K, Brown RH, Jr., Walz T, Lansbury PT, Jr. An intersubunit disulfide bond prevents in vitro aggregation of a superoxide dismutase-1 mutant linked to familial amyotrophic lateral sclerosis. *Biochemistry* 2004;43:4899-4905.
- (14) Hayward LJ, Rodriguez JA, Kim JW et al. Decreased metallation and activity in subsets of mutant superoxide dismutases associated with familial amyotrophic lateral sclerosis. *J Biol Chem* 2002;277:15923-15931.
- (15) Engvall E, Perlmann P. Enzyme-linked immunosorbent assay, Elisa. 3. Quantitation of specific antibodies by enzyme-labeled anti-immunoglobulin in antigen-coated tubes. *J Immunol* 1972;109:129-135.
- (16) Steinitz M. Quantitation of the blocking effect of tween 20 and bovine serum albumin in ELISA microwells. *Anal Biochem* 2000;282:232-238.
- (17) McQuillen DP, Gulati S, Ram S et al. Complement processing and immunoglobulin binding to *Neisseria gonorrhoeae* determined in vitro simulates in vivo effects. *J Infect Dis* 1999;179:124-135.
- (18) Ngampasutadol J, Rice PA, Walsh MT, Gulati S. Characterization of a peptide vaccine candidate mimicking an oligosaccharide epitope of *Neisseria gonorrhoeae* and resultant immune responses and function. *Vaccine* 2006;24:157-170.
- (19) Gnehm HE, Pelton SI, Gulati S, Rice PA. Characterization of antigens from nontypable *Haemophilus influenzae* recognized by human bactericidal antibodies. Role of *Haemophilus* outer membrane proteins. *J Clin Invest* 1985;75:1645-1658.
- (20) Rice PA, Vayo HE, Tam MR, Blake MS. Immunoglobulin G antibodies directed against protein III block killing of serum-resistant *Neisseria gonorrhoeae* by immune serum. *J Exp Med* 1986;164:1735-1748.
- (21) Mehta C, Patel N. StatXact8. In: *Software CS*, editor. Cambridge, MA 2008.
- (22) Rakhit R, Cunningham P, Furtos-Matei A et al. Oxidation-induced misfolding and aggregation of superoxide dismutase and its implications for amyotrophic lateral sclerosis. *J Biol Chem* 2002;277:47551-47556.



- (23) Durazo A, Shaw BF, Chattopadhyay M et al. Metal-free superoxide dismutase-1 and three different ALS variants share a similar partially unfolded {beta}-barrel at physiological temperature. *J Biol Chem* 2009;284:34382-34389.
- (24) Estevez AG, Crow JP, Sampson JB et al. Induction of nitric oxide-dependent apoptosis in motor neurons by zinc-deficient superoxide dismutase. *Science* 1999;286:2498-2500.
- (25) Lindberg MJ, Normark J, Holmgren A, Oliveberg M. Folding of human superoxide dismutase: disulfide reduction prevents dimerization and produces marginally stable monomers. *Proc Natl Acad Sci U S A* 2004;101:15893-15898.
- (26) Rakhit R, Crow JP, Lepock JR, Kondejewski LH, Cashman NR, Chakrabartty A. Monomeric Cu,Zn-superoxide dismutase is a common misfolding intermediate in the oxidation models of sporadic and familial amyotrophic lateral sclerosis. *J Biol Chem* 2004;279:15499-15504.
- (27) Cimini V, Ruggiero G, Buonomo T et al. CuZn-superoxide dismutase in human thymus: immunocytochemical localisation and secretion in thymus-derived epithelial and fibroblast cell lines. *Histochem Cell Biol* 2002;118:163-169.
- (28) Mondola P, Ruggiero G, Seru R et al. The Cu,Zn superoxide dismutase in neuroblastoma SK-N-BE cells is exported by a microvesicles dependent pathway. *Brain Res Mol Brain Res* 2003;110:45-51.
- (29) Garbuzova-Davis S, Saporta S, Haller E et al. Evidence of compromised blood-spinal cord barrier in early and late symptomatic SOD1 mice modeling ALS. *PLoS One* 2007;2:e1205.
- (30) Zhang R, Gascon R, Miller RG et al. Evidence for systemic immune system alterations in sporadic amyotrophic lateral sclerosis (sALS). *J Neuroimmunol* 2005;159:215-224.
- (31) Donnenfeld H, Kasczak RJ, Bartfeld H. Deposits of IgG and C3 in the spinal cord and motor cortex of ALS patients. *J Neuroimmunol* 1984;6:51-57.
- (32) Engelhardt JI, Appel SH. IgG reactivity in the spinal cord and motor cortex in amyotrophic lateral sclerosis. *Arch Neurol* 1990;47:1210-1216.
- (33) Demestre M, Pullen A, Orrell RW, Orth M. ALS-IgG-induced selective motor neurone apoptosis in rat mixed primary spinal cord cultures. *J Neurochem* 2005;94:268-275.
- (34) Smith RG, Alexianu ME, Crawford G, Nyormoi O, Stefani E, Appel SH. Cytotoxicity of immunoglobulins from amyotrophic lateral sclerosis patients on a hybrid motoneuron cell line. *Proc Natl Acad Sci U S A* 1994;91:3393-3397.
- (35) Pullen AH, Humphreys P. Ultrastructural analysis of spinal motoneurons from mice treated with IgG from ALS patients, healthy individuals, or disease controls. *J Neurol Sci* 2000;180:35-45.
- (36) Fridovich I. Superoxide anion radical (O<sub>2</sub><sup>-</sup>), superoxide dismutases, and related matters. *J Biol Chem* 1997;272:18515-18517.

## SUPPLEMENT

### Supplementary Materials and methods

#### Human subjects

The clinical features of the sporadic amyotrophic lateral sclerosis (SALS) cohort studied here are consistent with ALS:<sup>1</sup> the mean age of onset and diagnosis is 54.5 and 55.6 years, respectively; 226/289 (78%) of SALS patients presented with a limb onset compared to 63/289 (22%) with a bulbar onset; the mean duration of disease (from the age of onset to the age of death) is 3.3 years. Massachusetts General Hospital (MGH) also provided sera from 61 healthy controls and thirteen disease controls with neurological disorders other than ALS, including three with lower motor neuron disease (LMN), two with upper motor neuron disease (UMN), two with multiple sclerosis (MS), and one each with aseptic meningitis, demyelinating disease not otherwise specified, diagnostic lumbar puncture (LP), microangiopathic cerebrovascular disorder, peripheral neuropathy (PN) and primary lateral sclerosis (PLS). All healthy controls and 155 ALS patients participated in clinical trials for biomarkers; the remaining 143 ALS patients participated in a non-steroidal anti-inflammatory drug (NSAID) trial of Celebrex. Blood samples were obtained before treatment with Celebrex and, therefore, NSAIDs did not influence the antibody levels. All subjects participating in these studies signed an informed consent approved by the MGH Institutional Review Board (IRB) at the time of enrollment and the further use of their samples for research related to ALS has also been approved by the IRB.

The fifty individuals with a definite diagnosis of Alzheimer's disease (AD), and fifty patients with Parkinson's disease (PD), were obtained with IRB approval. Results of the Mini Mental State Exam (MMSE) were provided for 94% (141/150) of the cases, and results of the lower Unified Parkinson's Disease Rating Scale (UPDRS) were provided for 94% of the PD cases (47/50).

#### ELISA

Wells coated with 1 µg/mL affinity-purified goat anti-human IgG (or IgM) in NaCO<sub>3</sub> buffer (pH 9.6) were used to establish standard curves for the change in optical density as a function of IgG or IgM concentration.<sup>2</sup> The bound IgG (or IgM) was detected by using alkaline phosphatase conjugated to affinity purified goat anti-human IgG (or IgM) diluted 1:1,000 in phosphate-buffered saline with 0.05% Tween-20 (PBS-T). p-Nitrophenyl phosphate (Sigma) was used as the substrate and absorbance at 405 nm was measured at

time points between 0-30 minutes with a Victor X5 Multilabel Plate Reader (PerkinElmer). All antibodies used for this ELISA were purchased from Sigma-Aldrich. Each ELISA experiment was performed in duplicate on 2-3 separate occasions and the standard error of the mean of these experiments was used as a measure of variance. The classification of all sera samples were blinded to the experimentalist performing the ELISAs until after all replicate experiments were completed.

### Statistical analysis

The Spearman correlation between IgG and IgM isotypes for SOD1 antigens included those SALS cases with non-zero levels of both anti-SOD1 IgM and IgG antibodies. Parametric methods were used in the analyses as described below where distributional assumptions were met, using the SAS Statistical Package (SAS Institute Inc., V9.1). Where normality, variance, or sample size requirements were not met, comparable nonparametric methods available in SAS, the StatXact Statistical Package,<sup>3</sup> or GraphPad Prism software were employed. For the correlation of anti-SOD1 antibodies with SALS duration (SALS survival analysis), a Cox proportional hazards model was employed using the rank transforms of the anti-SOD1 antibody concentrations in order to create a uniformly-distributed explanatory variable. A Spearman's rank test was used to investigate correlations between anti-SOD1 antibody concentrations and the MMSE scores for the AD cohort, and UPDRS scores for the PD cohort.

## Supplementary References

- (1) Tandan R, Bradley WG. Amyotrophic lateral sclerosis: Part 1. Clinical features, pathology, and ethical issues in management. *Ann Neurol* 1985;18:271-280.
- (2) Engvall E, Perlmann P. Enzyme-linked immunosorbent assay, Elisa. 3. Quantitation of specific antibodies by enzyme-labeled anti-immunoglobulin in antigen-coated tubes. *J Immunol* 1972;109:129-135.
- (3) Mehta C, Patel N. StatXact8. In: *Software CS*, editor. Cambridge, MA 2008.

## Supplementary Tables

**Supplementary Table 19.1** Demographic and clinical features of anti-SOD1 antibodies for SALS and healthy control cohorts

| Feature                    | Group <sup>a</sup> | Number | IgG, SODox  | IgG, WT-SOD1 | IgM, SODox  | IgM, WT-SOD1 |
|----------------------------|--------------------|--------|-------------|--------------|-------------|--------------|
|                            |                    |        | μg/mL ± SE  | μg/mL ± SE   | μg/mL ± SE  | μg/mL ± SE   |
| Race <sup>b</sup>          | White              | 333    | 0.11 ± 0.02 | 0.23 ± 0.03  | 0.11 ± 0.02 | 0.50 ± 0.03  |
|                            | Other              | 25     | 0.09 ± 0.04 | 0.21 ± 0.06  | 0.05 ± 0.03 | 0.42 ± 0.06  |
| Gender <sup>c</sup>        | Male               | 207    | 0.12 ± 0.03 | 0.24 ± 0.04  | 0.12 ± 0.02 | 0.51 ± 0.05  |
|                            | Female             | 151    | 0.09 ± 0.03 | 0.20 ± 0.03  | 0.10 ± 0.02 | 0.47 ± 0.04  |
| Site of onset <sup>d</sup> | Limb               | 226    | 0.10 ± 0.03 | 0.21 ± 0.03  | 0.12 ± 0.02 | 0.52 ± 0.05  |
|                            | Bulbar             | 63     | 0.17 ± 0.07 | 0.27 ± 0.07  | 0.05 ± 0.01 | 0.36 ± 0.04  |

Abbreviations: WT-SOD1 = wild-type SOD1, SODox = oxidized WT-SOD1, and SE = standard error. <sup>a</sup> Sera samples for all subjects reported in this table were obtained through the Clinical Trials Unit at Massachusetts General Hospital (Methods). <sup>b</sup> Antibody levels were compared for SALS and healthy control subjects within the white-race categories compared to all other race categories. <sup>c</sup> Antibody levels were compared between male and female subjects belonging to the SALS and healthy control cohorts. <sup>d</sup> Antibody levels of SALS are compared between subjects who presented with a limb site of onset versus a bulbar site of onset. <sup>b-d</sup> None of the comparisons are significant.

**Supplementary Table 19.2** Correlation of anti-SOD1 antibodies with ages of serum collection and with the interval between serum collection and onset of symptoms

| Feature   | Number <sup>a</sup> | Spearman correlation coefficient <sup>b</sup> |              |                    |                     |                       |
|---|---------------------|---|--------------|--------------------|---------------------|-----------------------|
|   |                     | IgG, SODox                                    | IgG, WT-SOD1 | IgM, SODox         | IgM, WT-SOD1        |                       |
| Age of collection <sup>c</sup>                      | SALS                | 298   | 0.09         | <b>0.15 (0.01)</b> | <b>-0.11 (0.05)</b> | <b>-0.19 (0.0009)</b> |
|   | Healthy controls    | 61  | 0.11         | 0.15               | 0.17                | -0.08                 |
| Interval between age of collection and age of onset | SALS                | 294   | -0.06        | -0.10              | 0.01                | 0.03                  |

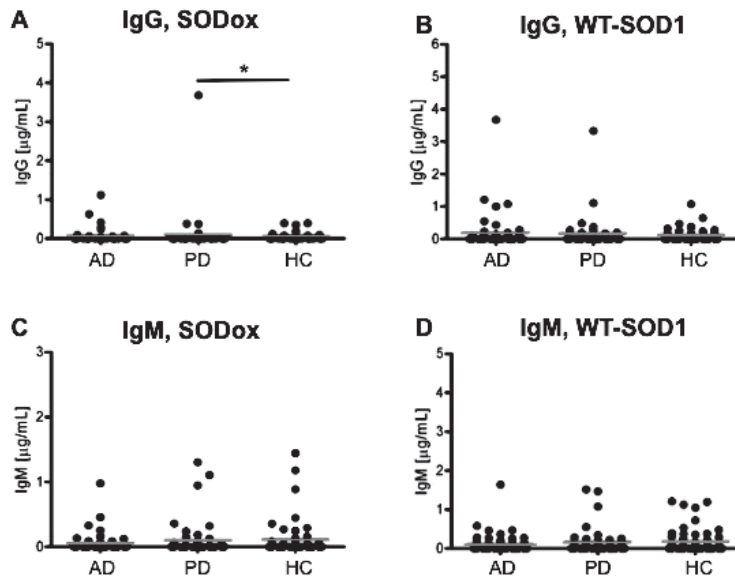
Abbreviation: SALS = sporadic amyotrophic lateral sclerosis. <sup>a</sup> Sera samples for all subjects reported in this table were obtained through the Clinical Trials Unit at Massachusetts General Hospital (Methods). <sup>b</sup> The Spearman coefficients are shown correlating levels of each antibody type with age of collection or with the interval between age of collection and onset of symptoms. Statistically significant correlations are highlighted in bold, and the corresponding p-values are shown in parentheses. <sup>c</sup> The mean ages of collection for SALS and healthy control cohorts are shown in Supplementary Table 19.1.

**Supplementary Table 19.3** Mean serum anti-SOD1 antibody concentrations for the top 10% SALS, healthy control and other neurological disease cases

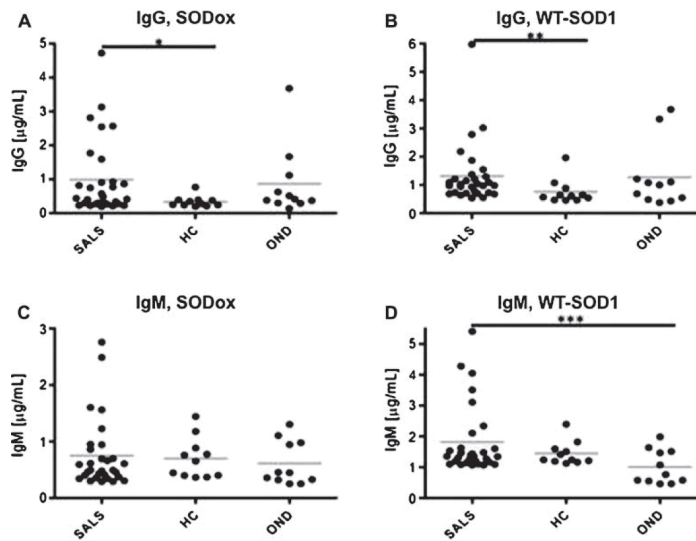
| Cohort <sup>a</sup>         | IgG, SODox                     |        | IgG, WT-SOD1                   |        | IgM, SODox  |        | IgM, WT-SOD1                   |        |
|-----------------------------|--------------------------------|--------|--------------------------------|--------|-------------|--------|--------------------------------|--------|
|                             | µg/mL ± SE                     | Number | µg/mL ± SE                     | Number | µg/mL ± SE  | Number | µg/mL ± SE                     | Number |
| SALS                        | <b>0.99 ± 0.20<sup>b</sup></b> | 30     | <b>1.31 ± 0.20<sup>c</sup></b> | 30     | 0.75 ± 0.11 | 30     | <b>1.82 ± 0.20<sup>d</sup></b> | 30     |
| Healthy controls            | 0.34 ± 0.05                    | 11     | 0.76 ± 0.13                    | 11     | 0.70 ± 0.11 | 11     | 1.45 ± 0.12                    | 11     |
| Other neurological diseases | 0.86 ± 0.31                    | 11     | 1.27 ± 0.35                    | 11     | 0.61 ± 0.12 | 11     | 1.01 ± 0.17                    | 11     |

<sup>a</sup> Sera samples for subjects reported in this table were obtained through the Clinical Trials Unit at Massachusetts General Hospital and Harvard NeuroDiscovery Center (Methods and Supplementary Figure 19.2). Statistical significance for each comparison was determined by the Wilcoxon Z-test, and those comparisons that remain significant after the Bonferroni correction ( $\alpha=0.05/\beta=0.0167$ ) are in bold font. <sup>b</sup> The difference in mean levels of anti-SODox IgG antibodies between SALS and healthy control cohorts is significant (p-value 0.0153). <sup>c</sup> The difference in mean levels of WT-SOD1 IgG antibodies between SALS and healthy control cohorts is significant (p-value 0.001). <sup>d</sup> The difference in mean levels of WT-SOD1 IgM antibodies between SALS and other neurological diseases is significant (p-value 0.023) by the Wilcoxon Z-test, but not after Bonferroni correction.

## Supplementary Figures



**Supplementary Figure 19.1** Anti-SOD1 antibodies are not generally elevated in Alzheimer's or Parkinson's disease cohorts. Sera samples for all subjects reported in this figure were obtained through the Harvard NeuroDiscovery Center (Methods). This figure illustrates anti-SOD1 antibody concentrations ( $\mu\text{g}/\text{mL}$ ) in sera from Alzheimer's disease (AD), Parkinson's disease (PD) and healthy control (HC) subjects. Sera concentrations are shown in a dot-graph representation as described in Figure 19.1. \*By virtue of a single elevated sample, the mean concentration of SODox IgG antibodies are significantly higher in the PD cohort ( $0.09 \mu\text{g}/\text{ml}$ ) compared to HC ( $0.04 \mu\text{g}/\text{ml}$ ,  $p$ -value 0.02), however this comparison is no longer significant after a Bonferroni correction. No other comparisons are statistically significant (Table 19.5).



**Supplementary Figure 19.2** The cases with the highest anti-SOD1 antibodies are within the SALS cohort, compared to HC and other neurologic disease (OND) cohorts. For this figure, the SALS cohort samples were from Massachusetts General Hospital (Table 19.1), the healthy control cohort is comprised of samples from Massachusetts General Hospital (Table 19.1) and Harvard NeuroDiscovery Center Biomarker Study (Table 19.4), and the OND cohort comprised of OND samples from Massachusetts General Hospital (Table 19.1) and AD and PD samples from Harvard NeuroDiscovery Center Biomarker Study (Table 19.4). Those cases within the highest 10% for anti-SOD1 antibody levels are plotted for each cohort, and are represented in a dot-graph format as in Figures 19.1 and 19.3. This figure illustrates that the cases with the highest anti-SODox IgG (A) and IgM (C) as well as WT-SOD1 IgG (B) and IgM (D) are consistently within the SALS cohort. The mean antibody concentration (Supplementary Table 19.2) is represented by a gray bar. \*Mean levels of auto-SODox IgG antibodies are significantly higher in SALS patient sera (0.99 µg/ml) compared to controls (0.34 µg/ml, p-value 0.02). \*\*Mean levels of WT-SOD1 IgG antibodies are significantly higher in SALS patient sera (1.31 µg/ml) compared to controls (0.76 µg/ml, p-value 0.001). \*\*\*Mean levels of WT-SOD1 IgM antibodies are significantly higher in SALS patient sera (1.82 µg/ml) compared to other neurological diseases (0.01 µg/ml, p-value 0.02).

# 20

**“No one should be alarmed by the great number of particulars, but think them rather a reason for hope.”**

Francis Bacon, *Novum Organum*.



## **General discussion and summary**

“I got worried during my pregnancy at the end of 2010. It took me several months, before I told my sister that I experienced difficulties in reaching my car navigation system, and that it became harder to drive my car as well. Normally, I would commute to my work five days a week, but I could not cope with it anymore. It became challenging to lift my right arm; it did not hurt, nor did my arm feel numb. I knew what the diagnosis might be, and that I had to see a doctor.”

## Genetic studies; amyotrophic lateral sclerosis (ALS)

Twenty years ago, we could only speculate about the causes of ALS. Since 5-10% of the ALS families demonstrated an autosomal dominant inheritance pattern, we did know that there had to be a genetic component. The discovery of mutations in superoxide dismutase-1 (*SOD1*), in 1993, catalyzed a search for other ALS-associated genes.<sup>1</sup> Although many genes were found to increase ALS susceptibility, most of these genes accounted for a small percentage of the cases. The recent detection of repeat expansions in chromosome 9 open reading frame 72 (*C9orf72*),<sup>2,3</sup> however, revealed the major genetic cause of familial ALS (FALS).

Only few FALS populations have been thoroughly screened for mutations in most of the ALS-associated genes. Toward this end, we have studied eleven genes in FALS patients of Dutch descent (**Chapter 3 – 11**). We demonstrated that they account for ~55% of the FALS families, and additionally, for ~12% of the apparently sporadic SALS (SALS) cases and ~5% of the control subjects (Table 20.1). The most frequent cause of FALS in The Netherlands was the repeat expansion in *C9orf72* (36%), followed by mutations in TAR DNA-binding protein (*TARDBP*; 8%) and fused in sarcoma / translated in liposarcoma (*FUS/TLS*; 6%).

### *C9orf72*, *TARDBP* and *FUS/TLS*

In this chapter, we will compare patients with mutations in *C9orf72* (n = 42), *TARDBP* (n = 13), and *FUS/TLS* (n = 6) to patients with mutations in other genes (both known and unknown [n = 55]). Table 20.2 demonstrates that *FUS/TLS* mutations resulted in an earlier age at onset as compared to patients with other mutations (41.8 years versus 60.6 years, p-value 0.001). Furthermore, the mean disease duration of patients with *FUS/*

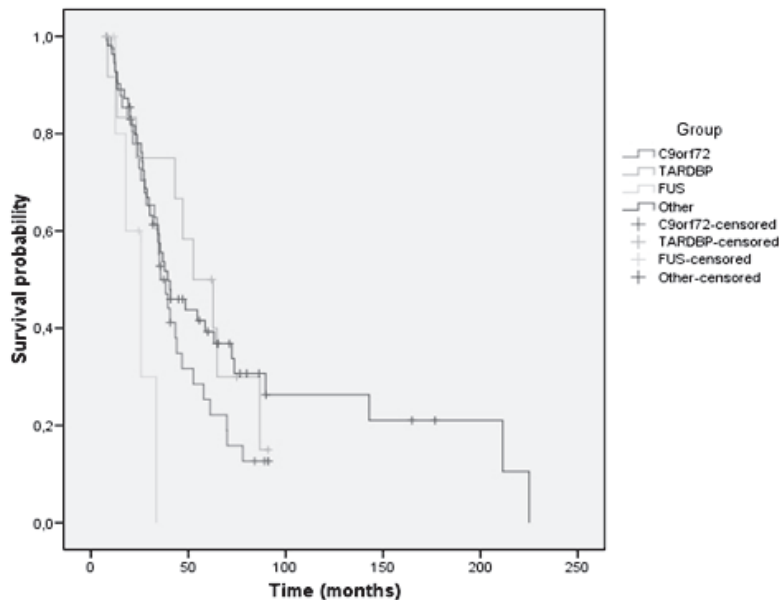
**Table 20.1** Overview of variants reported in this thesis

| Gene           | FALS (%)        | SALS (%) | CON (%) | Chapter |
|----------------|-----------------|----------|---------|---------|
| <i>PON</i>     | 2.5             | 1.4      | 2.5     | 3       |
| <i>OPTN</i>    | 0.0             | 0.3      | 0.1     | 4       |
| <i>VCP</i>     | 1.3             | 0.1      | 0.0     | 5       |
| <i>UBQLN2</i>  | 0.0             | -        | -       | 6       |
| <i>ATXN2</i>   | 1.5             | 0.5      | 0.0     | 7       |
| <i>C9orf72</i> | 36.1            | 6.1      | 0.0     | 9       |
| <i>TARDBP</i>  | 8.2             | 0.4      | 0.1     | 9       |
| <i>FUS/TLS</i> | 6.2             | 0.3      | 0.1     | 9       |
| <i>SOD1</i>    | 1.0             | 0.4      | 0.2     | 9       |
| <i>ANG</i>     | 2.1             | 0.6      | 0.1     | 9       |
| <i>VAPB</i>    | 3.1             | 1.5      | 1.4     | 10      |
| <i>CHMP2B</i>  | 0.0             | 0.3      | 0.1     | 11      |
| Total          | 55 <sup>a</sup> | 12       | 5       |         |

Abbreviations: FALS = familial amyotrophic lateral sclerosis families, SALS = sporadic amyotrophic lateral sclerosis, and CON = control subjects. <sup>a</sup> Families with variants in multiple genes were detected (**Chapter 9 and 10**), therefore, variants were identified in ~55% of the families (instead of 62%). A more detailed overview of the identified mutations is provided in Supplementary Table 20.1.

*TLS* mutations was shorter than the disease duration of patients with other mutations (21.0 months versus 53.9 months, p-value 0.013). To further investigate the effects of *C9orf72*, *TARDBP* and *FUS/TLS* mutations, we used a Cox proportional hazards model to assess survival, and adjusted for gender, age at onset, and site of onset (Figure 20.1).

This analysis revealed that the survival of patients with *FUS/TLS* mutations was significantly reduced (p-value 0.001, hazard ratio 6.5 [confidence interval [CI] 2.1-20.3]). Previously, a study already reported a relatively low age at onset of 44 years (n = 54) for patients with *FUS/TLS* mutations, and a fairly short disease duration of 3.4 years (n = 44), which is well in line with our findings.<sup>4</sup> Furthermore, another study also showed that patients with *FUS/TLS* mutations had a lower age at onset (45 years; n = 23) than other FALS patients (58 years; n = 115).<sup>5</sup> Moreover, they demonstrated that FALS patients with *FUS/TLS* mutations had a shorter disease duration of 2.5 years as compared to 3.8 years for other FALS patients (n = 100). Similar to our findings (Supplementary Table 20.2) none of these *FUS/TLS* patients demonstrated a slow disease progression of more than seven years.<sup>5</sup>



**Figure 20.1** Survival of FALS patients. Patients with *C9orf72*, *TARDBP* and *FUS/TLS* mutations, were compared to patients with other mutations. A Cox proportional hazards model was used, which corrected for gender, age at onset and site of onset (R v2.10 software [www.r-project.org]). The survival of patient with *FUS/TLS* mutations was significantly reduced (p-value 0.001, hazard ratio 6.5 [confidence interval [CI] 2.1-20.3]). See Appendix page 389 for Figure 20.1 in color.

*“When my maternity leave started, I felt very relieved, as if I had completed a mission. I was amazed by my own strength, and how long I had kept on working.”*

Although detailed information on cognitive and behavioral deficits was not available for all Dutch FALS families, we were able to add information from the prospective population based study on motor neuron diseases (MNDs) in The Netherlands, which registered the occurrence of dementia in family members of ALS patients.<sup>6</sup> As shown in Table 20.2 and Figure 20.2, dementia was more frequently encountered in FALS families with *C9orf72* repeat expansions than in FALS families with other mutations (p-value 0.023).

In **Chapter 8**, we already discussed that patients with *C9orf72* repeat expansions also appeared to have an earlier disease onset (2.5 years earlier) than patients without a *C9orf72* repeat (hazard ratio 1.5 [CI 1.2-1.8]). The same trend was observed for FALS patients with *C9orf72* repeat expansions as compared to FALS patients with other

**Table 20.2** Overview of variants reported in this thesis

|               |                         | <i>C9orf72</i><br>n = 42  | <i>TARDBP</i><br>n = 13 | <i>FUS/TLS</i><br>n = 6  | Other<br>n = 55 |
|---------------|-------------------------|---------------------------|-------------------------|--------------------------|-----------------|
| Gender        | % female / % male       | 52/48                     | 46/54                   | 33/67                    | 44/56           |
| Site of onset | % spinal / % bulbar     | 79/21                     | 85/15                   | 100/0                    | 80/20           |
| Dementia      | % positive / % negative | <b>52/48</b> <sup>a</sup> | 38/62                   | 0/100                    | 29/71           |
| Age at onset  | Mean (y)                | 58.8                      | 60.7                    | <b>41.8</b> <sup>b</sup> | 60.6            |
|               | Median (y)              | 60.1                      | 59.7                    | 37.8                     | 60.0            |
|               | 95% confidence Interval | 55 – 62                   | 53 – 68                 | 29 – 54                  | 57 – 64         |
| Duration      | Mean (m)                | 39.4                      | 49.1                    | <b>21.0</b> <sup>c</sup> | 53.9            |
|               | Median (m)              | 35.4                      | 52.6                    | 21.2                     | 37.9            |
|               | 95% confidence Interval | 32 – 47                   | 32 – 66                 | 12 – 30                  | 41 – 67         |

Abbreviations: n = number, y = years, and m = months. Clinical characteristics of ALS patients with *C9orf72* repeat expansions, *TARDBP* mutations and *FUS/TLS* mutations, were compared to patients with mutations in other genes. Disease duration was defined as the interval between age at onset and age at death or age last known to be alive. When patients with dementia in general (including frontotemporal dementia [FTD]) were reported in FALS families, these families were considered to be positive for dementia. Significant differences are indicated by the bold font. Bar graphs are shown in Figure 20.2. <sup>a</sup> P-value 0.023 (Fisher's exact test). <sup>b</sup> P-value 0.003 (Mann Whitney test). <sup>c</sup> P-value 0.013 (Mann Whitney test). P-values were calculated with GraphPad Prism version 5 (<http://www.graphpad.com>).

mutations (58.8 years versus 60.6 years). In addition, we reported (**Chapter 8**) that the median survival was nearly 2.5 months shorter in patients with *C9orf72* repeat expansions than in patients without this expansion. Within our FALS population we also detected a difference of 2.5 months between patients with *C9orf72* repeat expansions and patients with mutations in other genes (hazard ratio 1.6 [CI 0.9-2.5]). Because of the relatively small number of FALS patients, however, these differences between FALS patients with *C9orf72* repeat expansions and FALS patients with other mutations, did not reach significance.

Recently, another study reported a characterization of patients with *C9orf72* repeat expansions.<sup>7</sup> *C9orf72* repeat expansions were detected in ~41% of the FALS cases (n = 20) and ~5% of the SALS cases (n = 19). Phenotypic data was available for 21 of these patients and was compared to a cohort of 170 patients without this repeat expansion. They also reported that patients with *C9orf72* repeat expansions had an earlier age at disease onset (56.3 years versus 61.3 years), and they had significantly more co-morbid frontotemporal dementia (FTD) than patients without these repeats (50% versus 12%). Furthermore, they demonstrated a shortened survival in patients with *C9orf72* repeat expansions as compared to patients without these repeats (20 months versus

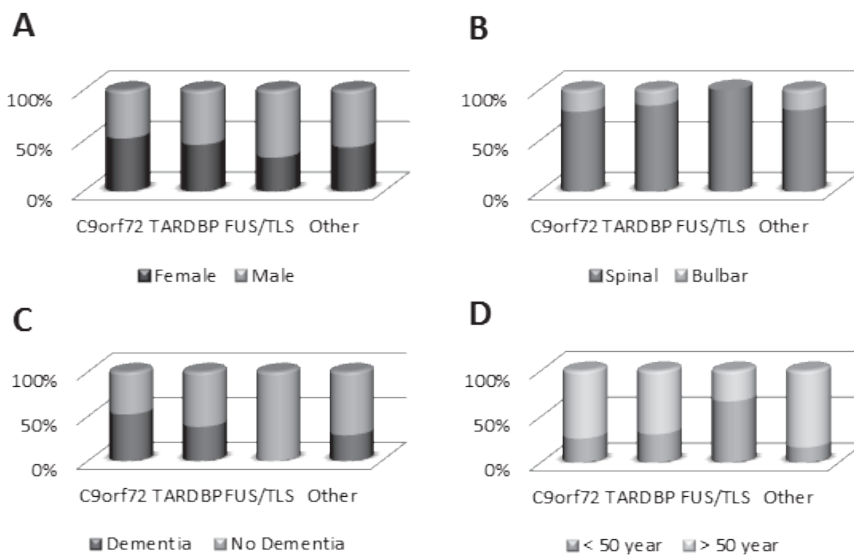
26 months).<sup>7</sup> Taken together, these findings suggest that patients with *C9orf72* repeat expansions are more frequently diagnosed with FTD, exhibit an earlier disease onset, and demonstrate reduced survival.

We also compared patients with *TARDBP* mutations to patients with mutations in other genes, but we did not detect significant differences in any of the clinical characteristics.

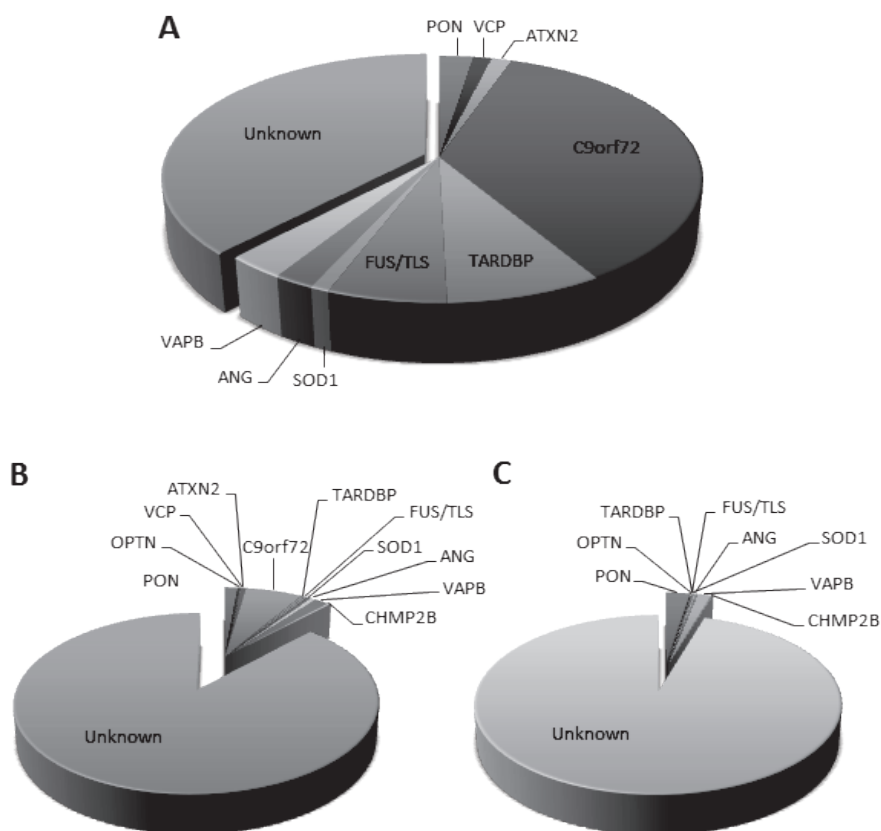
*“Thereafter, my symptoms progressed rapidly, and it became increasingly difficult to lift my head. During child birth, my husband had to hold my head, because I was unable to do so. Within seven minutes I held my son in my arms. I was exhausted.”*

### Mutations in other ALS-associated genes

We also investigated eight other ALS-associated genes (Table 20.1, Figure 20.3). In **Chapter 2**, we described the identification of paraoxonase (*PON*) mutations in ALS patients.<sup>8</sup> To further investigate these *PON* mutations, we studied a large cohort of ALS patients ( $n = 1,211$ ) and control subjects ( $n = 1,415$ ) of Dutch descent (**Chapter 3**). In this



**Figure 20.2** Bar graphs of clinical characteristics. Differences in gender (A), site of onset (B), dementia (C), and age at onset (D) are displayed. Patients with mutations in *C9orf72*, *TARDBP*, *FUS/TLS*, and other genes are shown. More information is provided in Table 20.2 and Supplementary Table 20.2.



**Figure 20.3** Pie chart with frequencies of non-synonymous mutations (%). For FALS (A), SALS (B) and control subjects (C), the distribution of mutations in ALS-associated genes is shown. We refer to Table 20.1 and Supplementary Table 20.1 for more detailed information. See Appendix page 390 for Figure 20.3 in color.

cohort, however, we did not detect significant differences between ALS patients and control subjects (1.5% versus 2.5%), and therefore, we demonstrate that *PON* mutations are not associated with ALS in The Netherlands.

In addition, we assessed the mutation frequency of three novel ALS-associated genes, namely, optineurin (*OPTN*), valosin-containing protein (*VCP*) and ubiquilin-2 (*UBQLN2*). Apart from the first report on *OPTN* mutations in Japanese ALS patients,<sup>9</sup> few other mutations have been described. In **Chapter 4**, however, we report two novel *OPTN* mutations in SALS patients (p.Q165X and p.Q454E).<sup>10</sup> One of these mutations (p.Q165X) has recently been shown to segregate with ALS in a Danish FALS family.<sup>11</sup> Other *OPTN*

mutations have been described in a cohort of Italian ALS patients (p.T282P, p.Q314L, p.K557T, and p.G23X).<sup>12</sup> Moreover, two mutations have been reported in FALS patients of French descent (c.382\_383insAG and p.R96L) and of mixed European descent (c.1242+1GA\_insA and p.A481V).<sup>13;14</sup>

Mutations in *VCP* are rare as well, and after the discovery of a *VCP* mutation (p.R191Q) in an Italian FALS patient,<sup>15</sup> not many mutations have been detected in other populations. In cohorts of Australian and Italian descent, for instance, no missense mutations in *VCP* were present in coding regions.<sup>16;17</sup> We did detect one *VCP* mutation in a FALS patient (p.R159H) and a SALS patient (p.I114V; **Chapter 5**).<sup>18</sup> To date, only one other mutation (p.I151V) has been described, this mutation was present in an African American SALS patient.<sup>19</sup>

In **Chapter 6**, we focused on *UBQLN2*, and showed that *UBQLN2* mutations were absent in FALS patients of Dutch descent. Since the first description of *UBQLN2* mutations as a cause of chromosome-X-linked ALS and ALS/dementia,<sup>20</sup> only one p.G502\_1504del has been reported in one French FALS patient, however, this variant did not segregate with the disease and was also present in one control subject.<sup>21</sup> Hence, mutations in *OPTN*, *VCP* and *UBQLN2* appear to be very rare causes of ALS.

We have already mentioned that *C9orf72* repeat expansions are the most common cause of ALS in The Netherlands. In 2010, an association between another repeat expansion, ataxin-2 (*ATXN2*), and ALS was reported.<sup>22</sup> We have investigated this repeat expansion in SALS patients from Belgium and The Netherlands (**Chapter 7**), and in this cohort, we detected a significant amount of intermediate repeat expansions in SALS patients as compared to control subjects (0.5% versus 0%).<sup>23</sup> Furthermore, *ATXN2* repeat expansions were also identified in 1.1% of the FALS families (1.5% of our Dutch FALS families).<sup>23</sup>

Other cohorts have been screened for *ATXN2* repeat expansions as well, and positive associations have been reported in Flanders-Belgian ALS patients,<sup>24</sup> French and French-Canadian ALS patients,<sup>25</sup> Chinese ALS patients,<sup>26</sup> and ALS patients from Central Europe and of general Caucasian ancestry.<sup>27;28</sup> In addition, the specificity of this association has been investigated, and while no association was detected between *ATXN2* repeat expansions and FTD-ALS, FTD, Parkinson's disease (PD) or Alzheimer's disease (AD),<sup>24;27;28</sup> there was an association with progressive supranuclear palsy (PSP).<sup>28</sup>

### Polygenic basis

Many of the FALS families in The Netherlands demonstrate a dominant inheritance pattern with incomplete penetrance. We hypothesized that this might be caused by



a polygenic inheritance of ALS, and therefore, we studied five major ALS-associated genes (*TARDBP*, *FUS/TLS*, *SOD1*, angiogenin (*ANG*), and *C9orf72*) in a cohort of 97 FALS families. In five of these families (5.2%) we detected two mutations (**Chapter 9**), which is in excess of what is expected by chance (p-value  $1.77 \times 10^{-7}$ ). Subsequently, we screened this cohort for mutations in vesicle-associated membrane protein B (*VAPB*; **Chapter 10**). We detected one novel *VAPB* mutation in a patient that was known to harbor a *C9orf72* repeat expansion. A complete overview of all patients detected with multiple variants in ALS-associated genes is provided in Table 20.3.

Mutations in these ALS-associated genes, have already been reported in patients with a wide range of clinical phenotypes, including (combinations of) FTD, PD, PSP, progressive muscular atrophy (PMA), primary lateral sclerosis (PLS), late-onset spinal muscular atrophy (SMA), chorea, motor- and vocal tics, sensory disorders, anarthria, and autonomic abnormalities.<sup>2,3;29-37;37-39;39-47</sup> We postulate that this phenotypic heterogeneity could be explained by a polygenic disease model, in which individual genes raise disease susceptibility and/or act as disease modifiers. In this model, the combined effects of variants in multiple genes result in the development of a particular clinical phenotype.

## Genetic studies; other neurodegenerative diseases

In PART II, we assessed the mutation frequency of ALS-associated genes in other neurodegenerative diseases. **Chapter 11 and 12** addressed PMA; a disease that affects lower motor neurons and accounts for 5-10% of the adult-onset MNDs.<sup>48-50</sup> Previously, clinical and pathological similarities have been reported between PMA and ALS.<sup>51-57</sup> We have already shown that *C9orf72* repeat expansions were present in 1.6% of the sporadic PMA patients (**Chapter 8**), and therefore, we decided to further investigate a potential genetic overlap between sporadic PMA and SALS. Towards this end, we screened apparently sporadic PMA patients for mutations in *SOD1*, *ANG*, *FUS/TLS*, and *TARDBP*. We detected mutations in 2.3% of the sporadic PMA patients, which was comparable to SALS patients (1.7%). In addition, we screened sporadic PMA patients and SALS patients for mutations in multivesicular body protein 2B (*CHMP2B*), these mutations had previously been identified in patients with PMA.<sup>58;59</sup> We identified *CHMP2B* mutations in 0.38% of the sporadic PMA patients and 0.30% of the SALS patients. Taken together, these findings provide strong evidence for a genetic overlap between PMA and ALS, and suggest that PMA should probably be considered a subtype of ALS.

In **Chapter 13 and 14**, we focused on PD, one of the most common neurodegenerative diseases. Commonalities between ALS and PD have been reported, for instance, mutations

**Table 20.3** Clinical information of FALS patients with multiple mutations

| Gene 1          | Mutation 1           | Gene 2         | Mutation 2             | Gender | Age at Onset (y) | Site of onset | Duration (m)      | Chapter |
|-----------------|----------------------|----------------|------------------------|--------|------------------|---------------|-------------------|---------|
| <i>PON3</i>     | p.G324D <sup>a</sup> | <i>C9orf72</i> | Long repeat            | F      | 52               | Cervical      | 61                | 3       |
| <i>TARDBP</i>   | p.N352S <sup>b</sup> | <i>TARDBP</i>  | p.N352S                | F      | 58               | Cervical      | > 62 <sup>d</sup> | 9       |
|                 | p.N352S <sup>b</sup> | <i>C9orf72</i> | Long repeat            | M      | 42               | Cervical      | > 91 <sup>d</sup> | 9       |
|                 | p.N352S <sup>b</sup> | <i>C9orf72</i> | Long repeat            | F      | 47               | Cervical      | > 15 <sup>d</sup> | 9       |
|                 | p.N352S <sup>c</sup> | <i>ANG</i>     | p.K171                 | M      | 61               | Cervical      | 8                 | 9       |
| <i>FUS/ITLS</i> | p.N352S <sup>c</sup> | <i>ANG</i>     | p.K171                 | F      | 73               | Lumbosacral   | 47                | 9       |
|                 | p.N352S <sup>c</sup> | <i>ANG</i>     | p.K171                 | M      | 54               | Cervical      | 52                | 9       |
|                 | p.Q210H              | <i>C9orf72</i> | Long repeat            | M      | 58               | Lumbosacral   | 25                | 9       |
|                 | p.R521C              | <i>VAPB</i>    | p.S160del <sup>a</sup> | M      | 29               | Lumbosacral   | 33                | 9       |
|                 | p.R521C              | <i>ANG</i>     | p.K171                 | F      | 53               | Lumbosacral   | > 24 <sup>d</sup> | 9       |
| <i>SOD1</i>     | p.D90A               | <i>C9orf72</i> | Long repeat            | F      | 51               | Cervical      | 77                | 9       |
| <i>VAPB</i>     | p.V234I              | <i>C9orf72</i> | Long repeat            | F      | 65               | Lumbosacral   | 34                | 10      |

Abbreviations: F = female and M = male. <sup>a</sup> The p.G324D *PON3* mutation, and the p.S160del *VAPB* mutation, have also been detected in control subjects and are unlikely to be pathogenic. <sup>b,c</sup> Patients with identical superscript characters are family members. <sup>d</sup> Patient is alive.

in *ANG* have been described in both ALS and PD patients (including Dutch PD patients).<sup>40</sup> Moreover, *TARDBP* mutations have infrequently been described in PD patients,<sup>39</sup> and TDP-43-positive inclusions have also been observed in ~7% of the PD cases.<sup>60</sup> To assess mutation frequency of *TARDBP* mutations in PD patients, we screened two cohorts of PD patients (n = 462 and n = 429). In none of these cohorts we detected *TARDBP* mutations, which emphasizes that *TARDBP* mutations are uncommon in PD patients.

*“Because my father had died of ALS, I already knew that I could develop ALS as well, but when I was diagnosed with ALS in June 2011, it hurt me. Currently (several months later), I am in constant need of help: with showering, getting dressed, lacing shoes, brushing my hair, eating, drinking...”*

After our initial identification of *PON* mutations in ALS patients (**Chapter 2**), we set out to investigate its mutation frequency in PD patients (**Chapter 15**), especially because of reports that showed an association between *PON* polymorphisms and PD.<sup>61</sup> We did detect *PON* mutations in PD patients; however, there was no significant difference between PD patients and control subjects (3.2% versus 2.2%). These findings indicate that *PON* mutations do not contribute to PD pathogenesis.

## Functional studies

PART III covered functional studies on the effects of ALS-associated mutations. In **Chapter 16**, we reviewed the role of *ANG*, elongator protein 3 (*ELP3*), *FUS/TLS*, senataxin (*SETX*), survival motor neuron (*SMN*) and TDP-43 in RNA processing pathways. Thereby, we showed that RNA processing is a common pathogenic pathway. To understand how alterations of this pathway can lead to ALS, we used HEK-293T cells to create a model for overexpression of wild-type *FUS/TLS*, knockdown of *FUS/TLS*, and two *FUS/TLS* mutations (**Chapter 17**). Subsequently, we performed RNA-Seq to identify differentially expressed genes or alternative splicing patterns. Our analysis demonstrated that *FUS/TLS* mainly affected ribosomal genes and spliceosome related genes. Moreover, we revealed that global transcription patterns of *FUS/TLS* mutations were more similar to our overexpression model than to *FUS/TLS* knockdown, which indicates that these mutations do not contribute to ALS pathogenesis due to a loss-of-function.

In **Chapter 18**, we used an ELISA to determine TDP-43 plasma levels in ALS patients and control subjects ( $n = 219$  and  $n = 100$ ). Our findings demonstrated a significant increase of plasma levels in ALS patients as compared to control subjects ( $p$ -value 0.023), and thereby, we showed that TDP-43 has potential as a biomarker, which could facilitate diagnosis of ALS and drug discovery. In the next chapter (**Chapter 19**), we investigated the hypothesis that aberrantly modified forms of SOD1 influence the disease course for SALS. We developed an ELISA to detect anti-SOD1 antibodies against wild-type SOD1 and aberrantly oxidized-SOD1 (as a model for mutated SOD1) in serum of ALS patients and control subjects. In 5-10% of the SALS cases we detected elevated antibody levels. Patients with IgM antibodies against aberrantly oxidized-SOD1, showed increased survival (6.4 years), indicating that these antibodies were protective. On the other hand, patients with IgG antibodies against wild-type SOD1 demonstrated reduced survival (4.1 years), highlighting the important role of wild-type SOD1 in reducing free radicals that can cause neuronal injury. Hereby, we have identified a potential immunotherapeutic target for ALS patients.

While ALS is a complex disease and many different genes appear to be involved in its pathogenesis, it is important to determine whether mutations lead to a final common pathway: another promising therapeutic target?

### Protein degradation

OPTN has been shown to regulate membrane trafficking, neuronal function, Golgi ribbon formation, exocytosis, transcription activation, and cellular morphogenesis.<sup>62-67</sup> It contains a motif to bind ubiquitin,<sup>68</sup> and is involved in the removal of intracellular components in lysosomes (autophagy).<sup>69</sup> OPTN-positive inclusions have been reported in ALS patients, and these inclusions co-localized with TDP-43 or SOD1.<sup>70</sup> Other studies have confirmed the presence of OPTN in ubiquitin- and TDP-43-positive spinal cords of ALS patients (without *SOD1* mutations).<sup>71,72</sup>

TDP-43-positive inclusions have also been detected in patients with *VCP* mutations, both in patients with ALS and in patients with inclusion body myopathy and Paget disease of bone with frontotemporal dementia (IBMPFD).<sup>73-75</sup> Interactions between *VCP* and TDP-43 have been detected as well, and *VCP* mutations have been shown to cause redistribution of TDP-43 to the cytoplasm, resulting in cytotoxicity.<sup>76</sup> *VCP* plays an essential role in autophagy and the endoplasmic reticulum associated degradation (ERAD),<sup>77,78</sup> which is necessary for the recognition of misfolded or mutated proteins for subsequent ubiquitination. In addition, *VCP* has been shown to deliver ubiquitinated

substrates to the proteasome and links them with ubiquitin machineries of the ubiquitin-proteasome system (UPS).<sup>77;78</sup> Consequently, mutations in *VCP* lead to non-degradable autophagosome accumulation, and impaired proteasome activity,<sup>79;80</sup> which seems to explain the formation of TDP-43 aggregates.

In X-linked ALS patients, inclusions have been detected that contained UBQLN2, ubiquitin, p62, TDP-43, FUS/TLS and OPTN.<sup>20</sup> These UBQLN2-positive inclusions have also been identified in patients with *SOD1* and *TARDBP* mutations, and in patients without *SOD1*, *TARDBP* and *FUS/TLS* mutations.<sup>20</sup> UBQLN2 has an amino-terminal ubiquitin-like domain (UBL) that interacts with the proteasome, and a carboxyl-terminal ubiquitin-associated domain (UBA) that interacts with ubiquitin.<sup>81</sup> These domains allow UBQLN2 to function as a chaperone that shuttles ubiquitinated substrates to the proteasome; mutations have previously been shown to impair this process.<sup>20;82</sup> Furthermore, UBQLN2 regulates autophagy, and disruption of autophagy could contribute to the formation of TDP-43-positive inclusions.<sup>83</sup>

Thus, OPTN, VCP and UBQLN2 are all involved in the degradation of proteins. Interestingly, overexpression of wild-type *VAPB* and mutated *VAPB*, lead to the aberrant accumulation of ubiquitin and ubiquitin-like proteins as well.<sup>84</sup> Treatment with an endoplasmic reticulum (ER) stress inhibitor (salubrinal) diminished the burden of ubiquitinated proteins, and it was thus suggested, that ER stress and disruption of the proteasome function contributed to the abnormal protein homeostasis.<sup>84</sup> Moreover, *VAPB* has also been shown to interact with unfolded protein response (UPR)-related transcription factor ATF6. Mutant *VAPB* impaired this interaction, and subsequently lead to deregulation of the UPR, resulting in protein accumulation.<sup>85;86</sup>

## RNA foci

We have discussed two repeat expansions: in *ATXN2* and in *C9orf72*. RNAs with repeat expansions form complex secondary structures that affect processing, transport and translation of these RNAs, and in addition, interactions with RNA-binding proteins.<sup>87</sup> Subsequently, these RNAs form nuclear RNA foci, which contain flawed RNA, overloaded with RNA-binding proteins.<sup>88</sup> The entrapment of these proteins can disrupt many cellular processes, including mRNA splicing, and could result in a toxic gain-of-function.<sup>87</sup> Repeat expansions are already known to cause at least 22 inherited neurological diseases.<sup>89</sup>

The intermediate *ATXN2* repeat expansions identified in ALS patients are interrupted CAG repeats, which contain one to three CAA codons.<sup>90</sup> These interruptions play an important role in conferring stability to the repeat, since interrupted repeats are

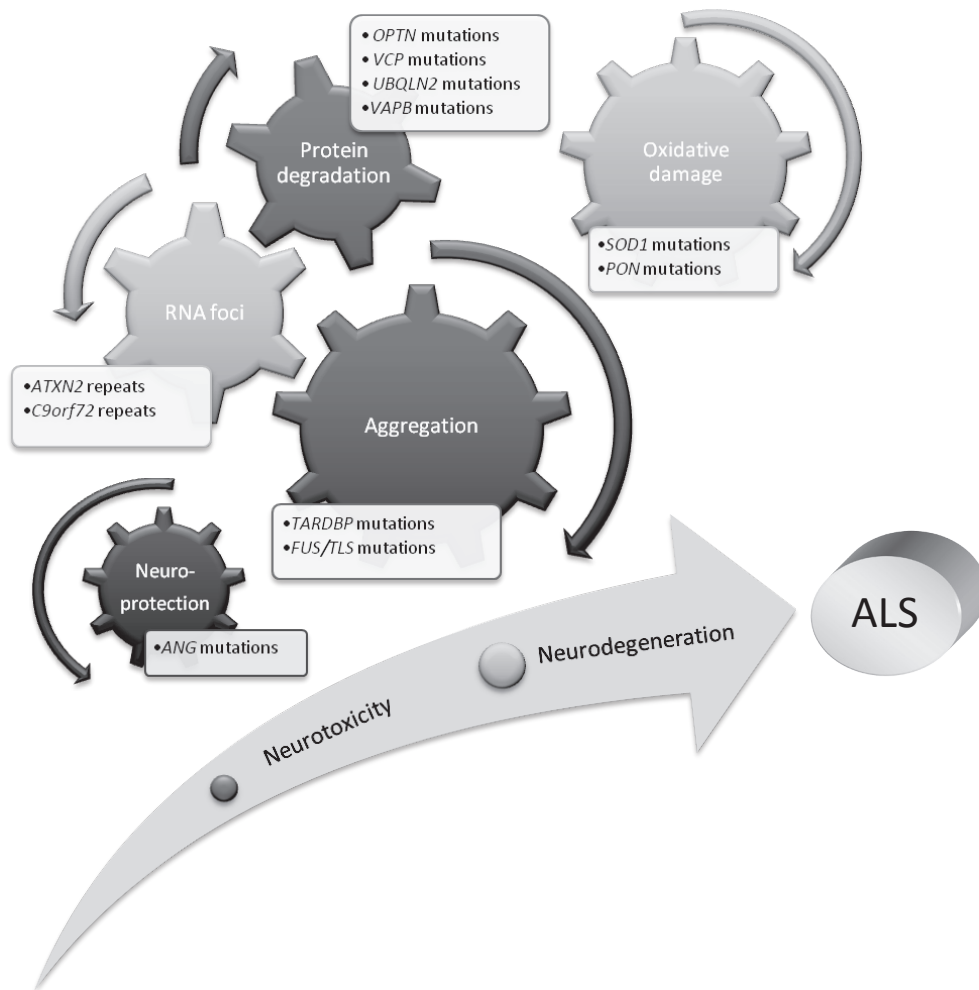
more stable.<sup>91</sup> Spinocerebellar ataxia type 2 (SCA2), for instance, is caused by  $\geq 34$  uninterrupted CAG repeats that form slippery hairpins.<sup>91;92</sup> ATXN2 has also been shown to enhance TDP-43 toxicity.<sup>22</sup> In spinal cord neurons from six ALS patients, the localization of ATXN2 was altered, and demonstrated cytoplasmic accumulations.<sup>22</sup>

Pathological examination of ten brains from Dutch patients with *C9orf72* repeat expansions, revealed TDP-43-positive inclusions in all brains.<sup>93</sup> Other studies have also detected TDP-43-positive inclusions,<sup>94-98</sup> and additionally, observed ubiquitin-positive, TDP-43-negative inclusions in a variety of neuroanatomical regions (e.g. cerebellar cortex), and p62 pathology in the cerebral cortex, hippocampus and cerebellum.<sup>95-97</sup> These findings highlight the common role of protein aggregation in the pathogenesis of ALS.

### Common pathway

Previously, we have mentioned that *SOD1* mutations probably affect the susceptibility to oxidation-induced misfolding, causing mutant specific protein interactions, and/or altered subcellular localization, which results in the formation of aggregates and inclusion bodies.<sup>99-102</sup> In addition, we have addressed the neuroprotective role of ANG,<sup>103</sup> the hydrolyzation of organophosphates and pesticides by PON, and how mutations in these genes could increase their vulnerability to stress.<sup>104;105</sup> Finally, we have reported the important role of TDP-43 and FUS/TLS in RNA processing pathways, and described the formation of TDP-43 and FUS/TLS aggregates.<sup>106</sup> In Figure 20.4, we propose a possible interaction between the eleven ALS-associated genes that have been addressed in this thesis, and thereby, we emphasize the complex etiology of ALS.

*“My son is nine months old now, and I have been unable to breastfeed him, nor can I change his diapers. My husband takes care of us, as if we are twins.”*



**Figure 20.4** Common pathways involved in the pathogenesis of ALS. The suggested effects of eleven ALS-associated genes are shown. Mutations in *OPTN*, *VCP*, *UBQLN2* and *VAPB* could impair protein degradation, which subsequently results in the accumulation of proteins (e.g. TDP-43) and aggregate formation. Repeat expansions in *ATXN2* and *C9orf72* probably lead to entrapment of flawed RNAs that attract many RNA-binding proteins (e.g. TDP-43), and thereby result in aggregate formation as well. *SOD1* and *PON* mutations appear to cause oxidative stress; mutant *SOD1* is also aggregation prone, and oxidation-induced misfolding most likely results in aggregate formation. Aggregation of mutant TDP-43 and *FUS/TLS* seems to disrupt the normal function of these proteins in RNA processing pathways, and additionally, could cause a toxic gain-of-function. *ANG* mutations probably raise ALS susceptibility, while they increase the vulnerability of neurons. To summarize, via diverse pathways these mutants lead to the formation of aggregates, which could be deleterious (neurotoxic) and/or impair cellular processes due to entrapment of proteins (loss-of-function). Eventually, this will result in degeneration of motor neurons, causing ALS. See Appendix page 391 for Figure 20.4 in color.

## References

- (1) Rosen DR, Siddique T, Patterson D et al. Mutations in Cu/Zn superoxide dismutase gene are associated with familial amyotrophic lateral sclerosis. *Nature* 1993;362:59-62.
- (2) Renton AE, Majounie E, Waite A et al. A Hexanucleotide Repeat Expansion in C9ORF72 Is the Cause of Chromosome 9p21-Linked ALS-FTD. *Neuron* 2011;72:257-268.
- (3) Dejesus-Hernandez M, Mackenzie IR, Boeve BF et al. Expanded GGGGCC Hexanucleotide Repeat in Noncoding Region of C9ORF72 Causes Chromosome 9p-Linked FTD and ALS. *Neuron* 2011;72:245-256.
- (4) Yan J, Deng HX, Siddique N et al. Frameshift and novel mutations in FUS in familial amyotrophic lateral sclerosis and ALS/dementia. *Neurology* 2010;75:807-814.
- (5) Millecamps S, Salachas F, Cazeneuve C et al. SOD1, ANG, VAPB, TARDBP, and FUS mutations in familial amyotrophic lateral sclerosis: genotype-phenotype correlations. *J Med Genet* 2010;47:554-560.
- (6) Huisman MH, de Jong SW, Verwijs MC et al. Family history of neurodegenerative and vascular diseases in ALS: a population-based study. *Neurology* 2011;77:1363-1369.
- (7) Byrne S, Elamin M, Bede P et al. Cognitive and clinical characteristics of patients with amyotrophic lateral sclerosis carrying a C9orf72 repeat expansion: a population-based cohort study. *Lancet Neurol* 2012;11:232-240.
- (8) Ticozzi N, Leclerc AL, Keagle PJ et al. Paraoxonase gene mutations in amyotrophic lateral sclerosis. *Ann Neurol* 2010;68:102-107.
- (9) Maruyama H, Morino H, Ito H et al. Mutations of optineurin in amyotrophic lateral sclerosis. *Nature* 2010;465:223-226.
- (10) van Blitterswijk M, van Vught PW, van Es MA et al. Novel optineurin mutations in sporadic amyotrophic lateral sclerosis patients. *Neurobiol Aging* 2011 Jul 27.
- (11) Tumer Z, Bertelsen B, Gredal O et al. A novel heterozygous nonsense mutation of the OPTN gene segregating in a Danish family with ALS. *Neurobiol Aging* 2012;33:208.e1-e5.
- (12) Del Bo R, Tiloca C, Pensato V et al. Novel optineurin mutations in patients with familial and sporadic amyotrophic lateral sclerosis. *J Neurol Neurosurg Psychiatry* 2011;82:1239-1243.
- (13) Millecamps S, Boillee S, Chabrol E et al. Screening of OPTN in French familial amyotrophic lateral sclerosis. *Neurobiol Aging* 2011;32:557.e11-e13.
- (14) Belzil VV, Daoud H, Desjarlais A et al. Analysis of OPTN as a causative gene for amyotrophic lateral sclerosis. *Neurobiol Aging* 2011;32:555.e13-e14.
- (15) Johnson JO, Mandrioli J, Benatar M et al. Exome sequencing reveals VCP mutations as a cause of familial ALS. *Neuron* 2010;68:857-864.
- (16) Tiloca C, Ratti A, Pensato V et al. Mutational analysis of VCP gene in familial amyotrophic lateral sclerosis. *Neurobiol Aging* 2012;33:630.e1-e2.



- (17) Williams KL, Solski JA, Nicholson GA, Blair IP. Mutation analysis of VCP in familial and sporadic amyotrophic lateral sclerosis. *Neurobiol Aging* 2011 Dec 21.
- (18) Koppers M, van Blitterswijk M, Vlam L et al. VCP mutations in familial and sporadic amyotrophic lateral sclerosis. *Neurobiol Aging* 2012;33:837.e7-e13.
- (19) Dejesus-Hernandez M, Desaro P, Johnston A et al. Novel p.Ile151Val mutation in VCP in a patient of African American descent with sporadic ALS. *Neurology* 2011;77:1102-1103.
- (20) Deng HX, Chen W, Hong ST et al. Mutations in UBQLN2 cause dominant X-linked juvenile and adult-onset ALS and ALS/dementia. *Nature* 2011;477:211-215.
- (21) Millicamps S, Corcia P, Cazeneuve C et al. Mutations in UBQLN2 are rare in French amyotrophic lateral sclerosis. *Neurobiol Aging* 2012;33:839.e1-e3.
- (22) Elden AC, Kim HJ, Hart MP et al. Ataxin-2 intermediate-length polyglutamine expansions are associated with increased risk for ALS. *Nature* 2010;466:1069-1075.
- (23) Van Damme P, Veldink JH, van Blitterswijk M et al. Expanded ATXN2 CAG repeat size in ALS identifies genetic overlap between ALS and SCA2. *Neurology* 2011;76:2066-2072.
- (24) Van Langenhove T, van der Zee J, Engelborghs S et al. Ataxin-2 polyQ expansions in FTL-ALS spectrum disorders in Flanders-Belgian cohorts. *Neurobiol Aging* 2011 Oct 27.
- (25) Daoud H, Belzil V, Martins S et al. Association of long ATXN2 CAG repeat sizes with increased risk of amyotrophic lateral sclerosis. *Arch Neurol* 2011;68:739-742.
- (26) Chen Y, Huang R, Yang Y et al. Ataxin-2 intermediate-length polyglutamine: a possible risk factor for Chinese patients with amyotrophic lateral sclerosis. *Neurobiol Aging* 2011;32:1925.e1-e5.
- (27) Gispert S, Kurz A, Waibel S et al. The modulation of Amyotrophic Lateral Sclerosis risk by ataxin-2 intermediate polyglutamine expansions is a specific effect. *Neurobiol Dis* 2012;45:356-361.
- (28) Ross OA, Rutherford NJ, Baker M et al. Ataxin-2 repeat-length variation and neurodegeneration. *Hum Mol Genet* 2011;20:3207-3212.
- (29) Borroni B, Archetti S, Del Bo R et al. TARDBP mutations in frontotemporal lobar degeneration: frequency, clinical features, and disease course. *Rejuvenation Res* 2010;13:509-517.
- (30) Borroni B, Bonvicini C, Alberici A et al. Mutation within TARDBP leads to frontotemporal dementia without motor neuron disease. *Hum Mutat* 2009;30:E974-E983.
- (31) Van Langenhove T, van der Zee J, Sleegers K et al. Genetic contribution of FUS to frontotemporal lobar degeneration. *Neurology* 2010;74:366-371.
- (32) Ticozzi N, Silani V, Leclerc AL et al. Analysis of FUS gene mutation in familial amyotrophic lateral sclerosis within an Italian cohort. *Neurology* 2009;73:1180-1185.
- (33) Benajiba L, Le Ber I, Camuzat A et al. TARDBP mutations in motoneuron disease with frontotemporal lobar degeneration. *Ann Neurol* 2009;65:470-473.

- (34) Broustal O, Camuzat A, Guillot-Noel L et al. FUS mutations in frontotemporal lobar degeneration with amyotrophic lateral sclerosis. *J Alzheimers Dis* 2010;22:765-769.
- (35) Mackenzie IR, Rademakers R, Neumann M. TDP-43 and FUS in amyotrophic lateral sclerosis and frontotemporal dementia. *Lancet Neurol* 2010;9:995-1007.
- (36) Blair IP, Williams KL, Warraich ST et al. FUS mutations in amyotrophic lateral sclerosis: clinical, pathological, neurophysiological and genetic analysis. *J Neurol Neurosurg Psychiatry* 2010;81:639-645.
- (37) Yan J, Deng HX, Siddique N et al. Frameshift and novel mutations in FUS in familial amyotrophic lateral sclerosis and ALS/dementia. *Neurology* 2010;75:807-814.
- (38) van Es MA, Diekstra FP, Veldink JH et al. A case of ALS-FTD in a large FALS pedigree with a K17I ANG mutation. *Neurology* 2009;72:287-288.
- (39) Quadri M, Cossu G, Saddi V et al. Broadening the phenotype of TARDBP mutations: the TARDBP Ala382Thr mutation and Parkinson's disease in Sardinia. *Neurogenetics* 2011;12:203-209.
- (40) van Es MA, Schelhaas HJ, van Vught PW et al. Angiogenin variants in Parkinson disease and amyotrophic lateral sclerosis. *Ann Neurol* 2011;70:964-973.
- (41) Lopate G, Baloh RH, Al-Lozi MT et al. Familial ALS with extreme phenotypic variability due to the I113T SOD1 mutation. *Amyotroph Lateral Scler* 2010;11:232-236.
- (42) Borghero G, Floris G, Cannas A et al. A patient carrying a homozygous p.A382T TARDBP missense mutation shows a syndrome including ALS, extrapyramidal symptoms, and FTD. *Neurobiol Aging* 2011;32:2327.e1-e5.
- (43) Kovacs GG, Murrell JR, Horvath S et al. TARDBP variation associated with frontotemporal dementia, supranuclear gaze palsy, and chorea. *Mov Disord* 2009;24:1843-1847.
- (44) Praline J, Your'ch P, Guennoc AM, Veyrat-Durebex C, Corcia P. Co-occurrence of progressive anarthria with an S393L TARDBP mutation and ALS within a family. *Amyotroph Lateral Scler* 2012;13:155-157.
- (45) Camdessanche JP, Belzil VV, Jousserand G et al. Sensory and motor neuronopathy in a patient with the A382P TDP-43 mutation. *Orphanet J Rare Dis* 2011;6:4.
- (46) Nishimura AL, Mitne-Neto M, Silva HC et al. A mutation in the vesicle-trafficking protein VAPB causes late-onset spinal muscular atrophy and amyotrophic lateral sclerosis. *Am J Hum Genet* 2004;75:822-831.
- (47) Marques VD, Barreira AA, Davis MB et al. Expanding the phenotypes of the Pro56Ser VAPB mutation: proximal SMA with dysautonomia. *Muscle Nerve* 2006;34:731-739.
- (48) Rowland LP. Progressive muscular atrophy and other lower motor neuron syndromes of adults. *Muscle Nerve* 2010;41:161-165.
- (49) Van Den Berg-Vos RM, Visser J, Franssen H et al. Sporadic lower motor neuron disease with adult onset: classification of subtypes. *Brain* 2003;126:1036-1047.
- (50) Van Den Berg-Vos RM, van den Berg LH, Visser J, de Visser M, Franssen H, Wokke JH. The spectrum of lower motor neuron syndromes. *J Neurol* 2003;250:1279-1292.

- (51) Visser J, Van Den Berg-Vos RM, Franssen H et al. Disease course and prognostic factors of progressive muscular atrophy. *Arch Neurol* 2007;64:522-528.
- (52) Traynor BJ, Codd MB, Corr B, Forde C, Frost E, Hardiman OM. Clinical features of amyotrophic lateral sclerosis according to the El Escorial and Airlie House diagnostic criteria: A population-based study. *Arch Neurol* 2000;57:1171-1176.
- (53) Kim WK, Liu X, Sandner J et al. Study of 962 patients indicates progressive muscular atrophy is a form of ALS. *Neurology* 2009;73:1686-1692.
- (54) Cudkowicz ME, McKenna-Yasek D, Chen C, Hedley-Whyte ET, Brown RH, Jr. Limited corticospinal tract involvement in amyotrophic lateral sclerosis subjects with the A4V mutation in the copper/zinc superoxide dismutase gene. *Ann Neurol* 1998;43:703-710.
- (55) Ince PG, Lowe J, Shaw PJ. Amyotrophic lateral sclerosis: current issues in classification, pathogenesis and molecular pathology. *Neuropathol Appl Neurobiol* 1998;24:104-117.
- (56) Ince PG, Evans J, Knopp M et al. Corticospinal tract degeneration in the progressive muscular atrophy variant of ALS. *Neurology* 2003;60:1252-1258.
- (57) Geser F, Stein B, Partain M et al. Motor neuron disease clinically limited to the lower motor neuron is a diffuse TDP-43 proteinopathy. *Acta Neuropathol* 2011;121:509-517.
- (58) Parkinson N, Ince PG, Smith MO et al. ALS phenotypes with mutations in CHMP2B (charged multivesicular body protein 2B). *Neurology* 2006;67:1074-1077.
- (59) Cox LE, Ferraiuolo L, Goodall EF et al. Mutations in CHMP2B in lower motor neuron predominant amyotrophic lateral sclerosis (ALS). *PLoS One* 2010;5:e9872.
- (60) Nakashima-Yasuda H, Uryu K, Robinson J et al. Co-morbidity of TDP-43 proteinopathy in Lewy body related diseases. *Acta Neuropathol* 2007;114:221-229.
- (61) Zintzaras E, Hadjigeorgiou GM. Association of paraoxonase 1 gene polymorphisms with risk of Parkinson's disease: a meta-analysis. *J Hum Genet* 2004;49:474-481.
- (62) Hattula K, Peranen J. FIP-2, a coiled-coil protein, links Huntingtin to Rab8 and modulates cellular morphogenesis. *Curr Biol* 2000;10:1603-1606.
- (63) Sahlender DA, Roberts RC, Arden SD et al. Optineurin links myosin VI to the Golgi complex and is involved in Golgi organization and exocytosis. *J Cell Biol* 2005;169:285-295.
- (64) Weisschuh N, Alavi MV, Bonin M, Wissinger B. Identification of genes that are linked with optineurin expression using a combined RNAi--microarray approach. *Exp Eye Res* 2007;85:450-461.
- (65) Anborgh PH, Godin C, Pampillo M et al. Inhibition of metabotropic glutamate receptor signaling by the huntingtin-binding protein optineurin. *J Biol Chem* 2005;280:34840-34848.
- (66) Li Y, Kang J, Horwitz MS. Interaction of an adenovirus E3 14.7-kilodalton protein with a novel tumor necrosis factor alpha-inducible cellular protein containing leucine zipper domains. *Mol Cell Biol* 1998;18:1601-1610.

- (67) Moreland RJ, Dresser ME, Rodgers JS et al. Identification of a transcription factor IIIA-interacting protein. *Nucleic Acids Res* 2000;28:1986-1993.
- (68) Wagner S, Carpentier I, Rogov V et al. Ubiquitin binding mediates the NF-kappaB inhibitory potential of ABIN proteins. *Oncogene* 2008;27:3739-3745.
- (69) Wild P, Farhan H, McEwan DG et al. Phosphorylation of the autophagy receptor optineurin restricts Salmonella growth. *Science* 2011;333:228-233.
- (70) Maruyama H, Morino H, Ito H et al. Mutations of optineurin in amyotrophic lateral sclerosis. *Nature* 2010;465:223-226.
- (71) Deng HX, Bigio EH, Zhai H et al. Differential involvement of optineurin in amyotrophic lateral sclerosis with or without SOD1 mutations. *Arch Neurol* 2011;68:1057-1061.
- (72) Hortobagyi T, Troakes C, Nishimura AL et al. Optineurin inclusions occur in a minority of TDP-43 positive ALS and FTLTDP cases and are rarely observed in other neurodegenerative disorders. *Acta Neuropathol* 2011;121:519-527.
- (73) Johnson JO, Mandrioli J, Benatar M et al. Exome sequencing reveals VCP mutations as a cause of familial ALS. *Neuron* 2010;68:857-864.
- (74) Neumann M, Mackenzie IR, Cairns NJ et al. TDP-43 in the ubiquitin pathology of frontotemporal dementia with VCP gene mutations. *J Neuropathol Exp Neurol* 2007;66:152-157.
- (75) Weihl CC, Temiz P, Miller SE et al. TDP-43 accumulation in inclusion body myopathy muscle suggests a common pathogenic mechanism with frontotemporal dementia. *J Neurol Neurosurg Psychiatry* 2008;79:1186-1189.
- (76) Ritson GP, Custer SK, Freibaum BD et al. TDP-43 mediates degeneration in a novel Drosophila model of disease caused by mutations in VCP/p97. *J Neurosci* 2010;30:7729-7739.
- (77) Halawani D, Latterich M. p97: The cell's molecular purgatory? *Mol Cell* 2006;22:713-717.
- (78) Weihl CC, Pestronk A, Kimonis VE. Valosin-containing protein disease: inclusion body myopathy with Paget's disease of the bone and fronto-temporal dementia. *Neuromuscul Disord* 2009;19:308-315.
- (79) Ju JS, Fuentealba RA, Miller SE et al. Valosin-containing protein (VCP) is required for autophagy and is disrupted in VCP disease. *J Cell Biol* 2009;187:875-888.
- (80) Gitcho MA, Strider J, Carter D et al. VCP mutations causing frontotemporal lobar degeneration disrupt localization of TDP-43 and induce cell death. *J Biol Chem* 2009;284:12384-12398.
- (81) Kleijnen MF, Alarcon RM, Howley PM. The ubiquitin-associated domain of hPLIC-2 interacts with the proteasome. *Mol Biol Cell* 2003;14:3868-3875.
- (82) Kim TY, Kim E, Yoon SK, Yoon JB. Herp enhances ER-associated protein degradation by recruiting ubiquilins. *Biochem Biophys Res Commun* 2008;369:741-746.
- (83) N'Diaye EN, Kajihara KK, Hsieh I, Morisaki H, Debnath J, Brown EJ. PLIC proteins or ubiquilins regulate autophagy-dependent cell survival during nutrient starvation. *EMBO Rep* 2009;10:173-179.

- (84) Moumen A, Virard I, Raoul C. Accumulation of wildtype and ALS-linked mutated VAPB impairs activity of the proteasome. *PLoS One* 2011;6:e26066.
- (85) Kanekura K, Suzuki H, Aiso S, Matsuoka M. ER stress and unfolded protein response in amyotrophic lateral sclerosis. *Mol Neurobiol* 2009;39:81-89.
- (86) Gkogkas C, Middleton S, Kremer AM et al. VAPB interacts with and modulates the activity of ATF6. *Hum Mol Genet* 2008;17:1517-1526.
- (87) Todd PK, Paulson HL. RNA-mediated neurodegeneration in repeat expansion disorders. *Ann Neurol* 2010;67:291-300.
- (88) Wojciechowska M, Krzyzosiak WJ. Cellular toxicity of expanded RNA repeats: focus on RNA foci. *Hum Mol Genet* 2011;20:3811-3821.
- (89) La Spada AR, Taylor JP. Repeat expansion disease: progress and puzzles in disease pathogenesis. *Nat Rev Genet* 2010;11:247-258.
- (90) Yu Z, Zhu Y, Chen-Plotkin AS et al. PolyQ repeat expansions in ATXN2 associated with ALS are CAA interrupted repeats. *PLoS One* 2011;6:e17951.
- (91) Choudhry S, Mukerji M, Srivastava AK, Jain S, Brahmachari SK. CAG repeat instability at SCA2 locus: anchoring CAA interruptions and linked single nucleotide polymorphisms. *Hum Mol Genet* 2001;10:2437-2446.
- (92) Sobczak K, Krzyzosiak WJ. CAG repeats containing CAA interruptions form branched hairpin structures in spinocerebellar ataxia type 2 transcripts. *J Biol Chem* 2005;280:3898-3910.
- (93) Simon-Sanchez J, Dopfer EG, Cohn-Hokke PE et al. The clinical and pathological phenotype of C9orf72 hexanucleotide repeat expansions. *Brain* 2012;135:723-735.
- (94) Snowden JS, Rollinson S, Thompson JC et al. Distinct clinical and pathological characteristics of frontotemporal dementia associated with C9ORF72 mutations. *Brain* 2012;135:693-708.
- (95) Stewart H, Rutherford NJ, Briemberg H et al. Clinical and pathological features of amyotrophic lateral sclerosis caused by mutation in the C9ORF72 gene on chromosome 9p. *Acta Neuropathol* 2012;123:409-417.
- (96) Troakes C, Maekawa S, Wijesekera L et al. An MND/ALS phenotype associated with C9orf72 repeat expansion: Abundant p62-positive, TDP-43-negative inclusions in cerebral cortex, hippocampus and cerebellum but without associated cognitive decline. *Neuropathology* 2011.
- (97) Al-Sarraj S, King A, Troakes C et al. p62 positive, TDP-43 negative, neuronal cytoplasmic and intranuclear inclusions in the cerebellum and hippocampus define the pathology of C9orf72-linked FTL and MND/ALS. *Acta Neuropathol* 2011;122:691-702.
- (98) Murray ME, Dejesus-Hernandez M, Rutherford NJ et al. Clinical and neuropathologic heterogeneity of c9FTD/ALS associated with hexanucleotide repeat expansion in C9ORF72. *Acta Neuropathol* 2011;122:673-690.

- (99) Chattopadhyay M, Valentine JS. Aggregation of copper-zinc superoxide dismutase in familial and sporadic ALS. *Antioxid Redox Signal* 2009;11:1603-1614.
- (100) Urushitani M, Sik A, Sakurai T, Nukina N, Takahashi R, Julien JP. Chromogranin-mediated secretion of mutant superoxide dismutase proteins linked to amyotrophic lateral sclerosis. *Nat Neurosci* 2006;9:108-118.
- (101) Magrane J, Hervias I, Henning MS, Damiano M, Kawamata H, Manfredi G. Mutant SOD<sub>1</sub> in neuronal mitochondria causes toxicity and mitochondrial dynamics abnormalities. *Hum Mol Genet* 2009;18:4552-4564.
- (102) Forsberg K, Jonsson PA, Andersen PM et al. Novel antibodies reveal inclusions containing non-native SOD<sub>1</sub> in sporadic ALS patients. *PLoS One* 2010;5:e11552.
- (103) Sebastia J, Kieran D, Breen B et al. Angiogenin protects motoneurons against hypoxic injury. *Cell Death Differ* 2009;16:1238-1247.
- (104) Aldridge WN. Serum esterases. I. Two types of esterase (A and B) hydrolysing p-nitrophenyl acetate, propionate and butyrate, and a method for their determination. *Biochem J* 1953;53:110-117.
- (105) Aldridge WN. Serum esterases. II. An enzyme hydrolysing diethyl p-nitrophenyl phosphate (E600) and its identity with the A-esterase of mammalian sera. *Biochem J* 1953;53:117-124.
- (106) van Blitterswijk M, Landers JE. RNA processing pathways in amyotrophic lateral sclerosis. *Neurogenetics* 2010;11:275-290.

# SUPPLEMENT

## Supplementary Tables

**Supplementary Table 20.1** Variants reported in this thesis

| Gene           | Mutation                   | Exon | FALS families (%)   | SALS (%)              | CON (%)              | Chapter |
|----------------|----------------------------|------|---------------------|-----------------------|----------------------|---------|
| <i>PON1</i>    | p.N19D                     | 1    | 0/80 (0.0)          | 1/1,118 (0.1)         | 2/1,240 (0.2)        | 3       |
|                | p.P40L                     | 2    | 0/80 (0.0)          | 0/1,118 (0.0)         | 1/1,240 (0.1)        |         |
|                | p.M127R                    | 5    | 0/80 (0.0)          | 0/1,118 (0.0)         | 6/1,240 (0.5)        |         |
|                | p.A201V                    | 6    | 0/80 (0.0)          | 4/1,498 (0.3)         | 7/2,375 (0.3)        |         |
|                | p.F293del                  | 8    | 0/80 (0.0)          | 1/1,118 (0.1)         | 0/1,240 (0.0)        |         |
| <i>PON3</i>    | p.E19X                     | 1    | 0/80 (0.0)          | 1/1,118 (0.1)         | 2/1,240 (0.2)        | 3       |
|                | p.R32X                     | 2    | 1/80 (1.3)          | 3/1,118 (0.3)         | 5/1,240 (0.4)        |         |
|                | p.D121N                    | 4    | 0/80 (0.0)          | 0/1,118 (0.0)         | 1/1,240 (0.1)        |         |
|                | p.I142V                    | 5    | 0/80 (0.0)          | 1/1,118 (0.1)         | 0/1,240 (0.0)        |         |
|                | p.T186S                    | 6    | 0/80 (0.0)          | 0/1,118 (0.0)         | 1/1,240 (0.1)        |         |
|                | p.V166M                    | 6    | 0/80 (0.0)          | 0/1,118 (0.0)         | 1/1,240 (0.1)        |         |
|                | p.L258Q                    | 7    | 0/80 (0.0)          | 0/1,118 (0.0)         | 1/1,240 (0.1)        |         |
|                | p.G324D                    | 9    | 1/80 (1.3)          | 5/1,118 (0.4)         | 7/1,240 (0.6)        |         |
|                | p.V345I                    | 9    | 0/80 (0.0)          | 1/1,118 (0.1)         | 0/1,240 (0.0)        |         |
|                | <b>Total <i>PON</i></b>    |      | <b>2 (2.5)</b>      | <b>17 (1.4)</b>       | <b>34 (2.5)</b>      |         |
| <i>OPTN</i>    | p.G159V                    | 6    | 0/80 (0.0)          | 1/1,191 (0.1)         | 1/1,415 (0.1)        | 4       |
|                | p.Q165X                    | 6    | 0/80 (0.0)          | 1/1,191 (0.1)         | 0/1,415 (0.0)        |         |
|                | p.Q454E                    | 13   | 0/80 (0.0)          | 1/1,191 (0.1)         | 0/1,415 (0.0)        |         |
|                | <b>Total <i>OPTN</i></b>   |      | <b>0 (0.0)</b>      | <b>3 (0.3)</b>        | <b>1 (0.1)</b>       |         |
| <i>VCP</i>     | p.I114V                    | 4    | 0/80 (0.0)          | 1/754 (0.1)           | 0/695 (0.0)          | 5       |
|                | p.R159H                    | 5    | 1/80 (1.3)          | 0/754 (0.0)           | 0/713 (0.0)          |         |
|                | <b>Total <i>VCP</i></b>    |      | <b>1 (1.3)</b>      | <b>1 (0.1)</b>        | <b>0 (0.0)</b>       |         |
| <i>UBQLN2</i>  | None                       |      | <b>0/84 (0.0)</b>   |                       |                      | 6       |
| <i>ATXN2</i>   | Repeat >31                 |      | <b>1/66 (1.5)</b>   | <b>8/1,460 (0.5)</b>  | <b>0/1,567 (0.0)</b> | 7       |
| <i>C9orf72</i> | Repeat >29                 |      | <b>35/97 (36.1)</b> | <b>87/1,422 (6.1)</b> | <b>0/748 (0.0)</b>   | 8       |
| <i>TARDBP</i>  | p.A90V                     | 3    | 1/97 (1.0)          | 1/1,192 (0.1)         | 1/1,415 (0.1)        | 9       |
|                | p.G295C                    | 6    | 1/97 (1.0)          | 0/1,192(0.0)          | 0/1,415 (0.0)        |         |
|                | p.N352S                    | 6    | 5/97 (5.2)          | 3/1,192(0.3)          | 0/1,415 (0.0)        |         |
|                | p.I383V                    | 6    | 1/97 (1.0)          | 1/1,192(0.1)          | 0/1,415 (0.0)        |         |
|                | <b>Total <i>TARDBP</i></b> |      | <b>8 (8.2)</b>      | <b>5 (0.4)</b>        | <b>1 (0.1)</b>       |         |

Supplementary Table 20.1 continues on next page

**Supplementary Table 20.1** *Continued*

| Gene                       | Mutation                    | Exon           | FALS families (%) | SALS (%)          | CON (%)         | Chapter |
|----------------------------|-----------------------------|----------------|-------------------|-------------------|-----------------|---------|
| <i>FUS/TLS</i>             | p.S115N                     | 5              | 0/97 (0.0)        | 1/1,192 (0.1)     | 0/970 (0.0)     | 9       |
|                            | p.Q210H                     | 6              | 1/97 (1.0)        | 0/1,192 (0.0)     | 1/970 (0.1)     |         |
|                            | p.R487C                     | 14             | 0/97 (0.0)        | 1/1,192 (0.1)     | 0/970 (0.0)     |         |
|                            | p.R495X                     | 14             | 0/97 (0.0)        | 1/1,192 (0.1)     | 0/970 (0.0)     |         |
|                            | p.R521H                     | 15             | 1/97 (1.0)        | 0/1,192 (0.0)     | 0/970 (0.0)     |         |
|                            | p.R521C                     | 15             | 4/97 (4.1)        | 0/1,192 (0.0)     | 0/970 (0.0)     |         |
|                            | <b>Total <i>FUS/TLS</i></b> |                | <b>6 (6.2)</b>    | <b>3 (0.3)</b>    | <b>1 (0.1)</b>  |         |
| <i>SOD1</i>                | p.D90A                      | 4              | 1/97 (1.0)        | 1/451 (0.2)       | 3/1,894 (0.2)   | 9       |
|                            | p.I113T                     | 4              | 0/97 (0.0)        | 0/451 (1.0)       | 0/1,894 (0.0)   |         |
|                            | p.I99V                      | 4              | 0/97 (0.0)        | 1/451 (0.2)       | 0/1,894 (0.0)   |         |
|                            | <b>Total <i>SOD1</i></b>    |                | <b>1 (1.0)</b>    | <b>2 (0.4)</b>    | <b>3 (0.2)</b>  |         |
| <i>ANG</i>                 | p.G(-10)D                   | 2              | 0/97 (0.0)        | 1/941 (0.1)       | 0/1,582 (0.0)   | 9       |
|                            | p.K171                      | 2              | 2/97 (2.1)        | 3/941 (0.3)       | 2/1,582 (0.1)   |         |
|                            | p.T80S                      | 2              | 0/97 (0.0)        | 1/941 (0.1)       | 0/1,582 (0.0)   |         |
|                            | p.F100I                     | 2              | 0/97 (0.0)        | 1/941 (0.1)       | 0/1,582 (0.0)   |         |
| <b>Total <i>ANG</i></b>    |                             | <b>2 (2.1)</b> | <b>6 (0.6)</b>    | <b>2 (0.1)</b>    |                 |         |
| <i>VAPB</i>                | p.A104T                     | 3              | 0/97 (0.0)        | 0/755 (0.0)       | 1/765 (0.1)     | 10      |
|                            | p.D130E                     | 4              | 0/97 (0.0)        | 1/755 (0.1)       | 0/765 (0.0)     |         |
|                            | p.S158N                     | 5              | 1/97 (1.0)        | 0/755 (0.0)       | 1/765 (0.1)     |         |
|                            | p.S160del                   | 5              | 1/97 (1.0)        | 5/755 (0.7)       | 4/765 (0.5)     |         |
|                            | p.M170I                     | 5              | 0/97 (0.0)        | 5/755 (0.7)       | 5/765 (0.7)     |         |
|                            | p.V234I                     | 6              | 1/97 (1.0)        | 0/755 (0.0)       | 0/765 (0.0)     |         |
| <b>Total <i>VAPB</i></b>   |                             | <b>3 (3.1)</b> | <b>11 (1.5)</b>   | <b>11 (1.4)</b>   |                 |         |
| <i>CHMP2B</i>              | p.R22Q                      | 2              | 0/80 (0.0)        | 1/1,002           | 0/750           | 11      |
|                            | p.N54T                      | 3              | 0/80 (0.0)        | 1/1,002           | 0/750           |         |
|                            | p.R69Q                      | 3              | 0/80 (0.0)        | 0/1,002           | 0/750           |         |
|                            | p.T83I                      | 3              | 0/80 (0.0)        | 1/1,002           | 0/750           |         |
|                            | p.S194L                     | 6              | 0/80 (0.0)        | 0/1,002           | 0/750           |         |
| <b>Total <i>CHMP2B</i></b> |                             | <b>0 (0.0)</b> | <b>3 (0.3)</b>    | <b>1 (0.1)</b>    |                 |         |
| <b>Combined</b>            | <b>Total (%)</b>            |                | <b>52 (54.7)</b>  | <b>146 (12.0)</b> | <b>54 (4.6)</b> |         |

Abbreviations: FALS = familial amyotrophic lateral sclerosis, SALS = sporadic amyotrophic lateral sclerosis, and CON = control subject. Variants in genes discussed in this thesis accounted for 54.7% of the FALS families, 12.0% of the SALS patients, and 4.6% of the control subjects. <sup>a</sup> Families with variants in multiple genes were detected, therefore, variants were identified in 54.7% of the families, instead of 62.0%. A summary is provided in Table 20.1. Clinical characteristics of identified FALS patients are shown in Supplementary Table 20.2.



**Supplementary Table 20.2** Clinical information on FALS patients reported in this thesis

| Gene 1                   | Mutation 1               | Gene 2  | Mutation 2               | Gender | Age at onset (y) | Site of onset | Duration (m)      | Chapter |
|--------------------------|--------------------------|---------|--------------------------|--------|------------------|---------------|-------------------|---------|
| PON                      | p.R32X                   |         |                          | F      | 51               | Lumbosacral   | 13                | 3       |
|                          | p.G324D                  | C9orf72 | Long repeat <sup>a</sup> | F      | 52               | Cervical      | 61                |         |
| VCP                      | p.R159H                  |         |                          | F      | 59               | Cervical      | 23                | 5       |
| ATXN2                    | 33:33 <sup>b</sup>       |         |                          | M      | 71               | Lumbosacral   | > 76 <sup>j</sup> | 7       |
|                          | 31:33 <sup>b</sup>       |         |                          | M      | 75               | Lumbosacral   | > 60 <sup>j</sup> |         |
| C9orf72                  | Long repeat <sup>a</sup> |         |                          | M      | 58               | Cervical      | 35                | 9       |
|                          | Long repeat <sup>a</sup> |         |                          | M      | 49               | Lumbosacral   | 39                |         |
|                          | Long repeat <sup>c</sup> |         |                          | F      | 49               | Cervical      | 44                |         |
|                          | Long repeat <sup>c</sup> |         |                          | M      | 66               | Cervical      | 16                |         |
|                          | Long repeat              |         |                          | F      | 59               | Lumbosacral   | 43                |         |
|                          | Long repeat <sup>d</sup> |         |                          | F      | 69               | Bulbar        | 12                |         |
|                          | Long repeat <sup>d</sup> |         |                          | M      | 45               | Cervical      | > 91 <sup>j</sup> |         |
|                          | Long repeat              |         |                          | F      | 66               | Bulbar        | 21                |         |
|                          | Long repeat              |         |                          | M      | 62               | Lumbosacral   | > 89 <sup>j</sup> |         |
|                          | Long repeat              |         |                          | F      | 49               | Lumbosacral   | > 84 <sup>j</sup> |         |
|                          | Long repeat <sup>e</sup> |         |                          | M      | 60               | Lumbosacral   | 10                |         |
|                          | Long repeat <sup>e</sup> |         |                          | M      | 74               | Bulbar        | 28                |         |
|                          | Long repeat              |         |                          | M      | 74               | Lumbosacral   | 34                |         |
| Long repeat              |                          |         | F                        | 57     | Lumbosacral      | 40            |                   |         |
| Long repeat              |                          |         | F                        | 60     | Cervical         | 46            |                   |         |
| Long repeat              |                          |         | F                        | 61     | Lumbosacral      | 21            |                   |         |
| Long repeat              |                          |         | F                        | 52     | Lumbosacral      | 52            |                   |         |
| Long repeat              |                          |         | M                        | 63     | Cervical         | 69            |                   |         |
| Long repeat              |                          |         | F                        | 58     | Cervical         | 33            |                   |         |
| Long repeat <sup>f</sup> |                          |         | F                        | 70     | Lumbosacral      | 35            |                   |         |

Supplementary Table 20.2 continues on next page

Supplementary Table 20.2 Continued

| Gene 1        | Mutation 1               | Gene 2         | Mutation 2  | Gender | Age at onset (y) | Site of onset | Duration (m)      | Chapter |
|---------------|--------------------------|----------------|-------------|--------|------------------|---------------|-------------------|---------|
|               | Long repeat <sup>f</sup> |                |             | F      | 64               | Lumbosacral   | 15                |         |
|               | Long repeat              |                |             | M      | 45               | Cervical      | 32                |         |
|               | Long repeat              |                |             | F      | 70               | Bulbar        | 57                |         |
|               | Long repeat              |                |             | F      | 50               | Bulbar        | 27                |         |
|               | Long repeat              |                |             | F      | 61               | Cervical      | 12                |         |
|               | Long repeat              |                |             | F      | 39               | Lumbosacral   | 13                |         |
|               | Long repeat              |                |             | M      | 73               | Bulbar        | 24                |         |
|               | Long repeat              |                |             | M      | 61               | Lumbosacral   | > 35 <sup>j</sup> |         |
|               | Long repeat              |                |             | F      | 56               | Cervical      | > 40 <sup>j</sup> |         |
|               | Long repeat              |                |             | M      | 43               | Cervical      | 69                |         |
|               | Long repeat              |                |             | M      | 41               | Bulbar        | 38                |         |
|               | Long repeat              |                |             | M      | 78               | Lumbosacral   | 18                |         |
|               | Long repeat              |                |             | F      | 61               | Bulbar        | > 20 <sup>j</sup> |         |
|               | Long repeat              |                |             | M      | 63               | Bulbar        | 24                |         |
|               | Long repeat              |                |             | M      | 44               | Lumbosacral   | > 35 <sup>j</sup> |         |
|               | Long repeat              |                |             | M      | 77               | Cervical      | > 37 <sup>j</sup> |         |
| <i>TARDBP</i> | p.A90V                   |                |             | F      | 72               | Bulbar        | 23                | 9       |
|               | p.G295C                  |                |             | F      | 80               | Bulbar        | 43                |         |
|               | p.N352S <sup>g</sup>     | <i>TARDBP</i>  | p.N352S     | F      | 58               | Cervical      | > 62 <sup>j</sup> |         |
|               | p.N352S <sup>g</sup>     | <i>C9orf72</i> | Long repeat | M      | 42               | Cervical      | > 91 <sup>j</sup> |         |
|               | p.N352S <sup>g</sup>     | <i>C9orf72</i> | Long repeat | F      | 47               | Cervical      | > 15 <sup>j</sup> |         |
|               | p.N352S <sup>h</sup>     |                |             | M      | 59               | Cervical      | 86                |         |
|               | p.N352S <sup>h</sup>     |                |             | F      | 64               | Cervical      | 66                |         |

|                |                      |         |             |   |    |             |                   |
|----------------|----------------------|---------|-------------|---|----|-------------|-------------------|
|                | p.N352S <sup>i</sup> | ANG     | p.K171      | M | 61 | Cervical    | 8                 |
|                | p.N352S <sup>i</sup> | ANG     | p.K171      | F | 73 | Lumbosacral | 47                |
|                | p.N352S <sup>i</sup> | ANG     | p.K171      | M | 54 | Cervical    | 52                |
|                | No <sup>i</sup>      | ANG     | p.K171      | M | 74 | Cervical    | 37                |
|                | p.N352S              |         |             | M | 49 | Cervical    | > 75 <sup>j</sup> |
|                | p.N352S              |         |             | M | 76 | Cervical    | 13                |
|                | p.I383V              |         |             | M | 46 | Lumbosacral | 64                |
| <i>FUS/TL5</i> | p.Q210H              | C9orf72 | Long repeat | M | 58 | Lumbosacral | 25                |
|                | p.R521H              |         |             | M | 39 | Cervical    | 12                |
|                | p.R521C              | VAPB    | p.S160del   | M | 29 | Lumbosacral | 33                |
|                | p.R521C              |         |             | M | 36 | Cervical    | 17                |
|                | p.R521C              |         |             | F | 33 | Cervical    | > 11 <sup>j</sup> |
|                | p.R521C              | ANG     | p.K171      | F | 53 | Lumbosacral | > 24 <sup>j</sup> |
| <i>SOD1</i>    | p.D90A               | C9orf72 | Long repeat | F | 51 | Cervical    | 77                |
| <i>VAPB</i>    | p.S158N              |         |             | F | 50 | Bulbar      | 12                |
|                | p.V234I              | C9orf72 | Long repeat | F | 65 | Lumbosacral | 34                |

Abbreviations: F = female, M = male, Y = years, and m = months. <sup>a-i</sup> Patients with the identical superscript characters are family members. <sup>j</sup> Patient is alive.

**“Ik merk dat u een peroratie verwacht, maar als u denkt dat ik me nog iets herinner van wat ik gezegd heb, van heel die woordenbrij die ik eruit heb gegoid, bent u wel erg dwaas.”**

Desiderius Erasmus, Lof der Zotheid.

## **Samenvatting (Summary in Dutch)**

Amyotrofische laterale sclerose (ALS) is een zeer ernstige aandoening, die resulteert in progressieve spierzwakte van de ledematen, het gelaat en de romp. Over het algemeen overlijden ALS-patiënten binnen vijf jaar door problemen met de ademhaling. Er is slechts een medicijn, riluzole, dat de overleving met enkele maanden kan verlengen.

*“Mijn naam is N., toen ik 18 jaar was kreeg ik te horen dat bij mijn vader de diagnose ALS gesteld was. Ik was op die dag bij een vriend en moest van mijn moeder direct naar huis komen, eenmaal thuis gekomen kreeg ik van mijn vader te horen dat hij de ziekte ALS heeft en dat de artsen verteld hadden dat hij minder dan vijf jaar te leven had. Vooral die laatste woorden kwamen hard aan en ik werd ontzettend boos: ik begon te schreeuwen en heb tegen een aantal meubels in huis aangeschopt. Mijn sterke hardwerkende vader ALS, binnen vijf jaar zou hij zijn overleden? Ik kon het niet geloven. Net als veel mensen nu, had ik toen ook nog niet eerder van ALS gehoord. Ik ben direct op het internet gaan zoeken en kwam de meest vreselijke verhalen tegen. Ik werd er ontzettend verdrietig van en kon niet bevatten dat mijn vader deze ziekte ineens had gekregen.”*

*“Inmiddels zijn we zeven jaar verder en we mogen van geluk spreken: mijn vader is nog steeds bij ons. De ziekte verliep bij hem gelukkig minder snel dan bij de meeste ALS-patiënten. Wel zijn stukje voor stukje veel functies uitgevallen. Het begon met zijn armen en vervolgens kwamen zijn benen aan de beurt. Op dit moment zit hij in een rolstoel, al probeert hij in huis nog wel te lopen met behulp van een rollator. Dit gaat heel langzaam, het is echter goed te zien dat hij hier nog kracht voor heeft. Het is voor mij heel moeilijk dat mijn vader, die vroeger hard werkte en zowel geestelijk als lichamelijk heel sterk was, zo achteruit gaat. Dit doet me erg veel pijn.”*

ALS wordt veroorzaakt door een ingewikkeld samenspel van erfelijke factoren en invloeden uit de omgeving, waardoor motorische neuronen afsterven. In vijf tot tien procent van de gevallen komen er meerdere ALS-patiënten in de familie voor (familiaire ALS); in dit proefschrift hebben we ons toegelegd op deze familiale vorm. We bestudeerden het erfelijk materiaal (DNA) van patiënten en brachten daarmee bepaalde gebieden (genen) in kaart.

*“Ongeveer twee jaar geleden kreeg mijn tante problemen met haar hand. Ze kon bijvoorbeeld het bestek niet goed meer vastpakken. Mijn tante hoopte zo dat het niet door ALS kwam, maar helaas kreeg zij binnen een half jaar dezelfde diagnose als mijn vader. Dit was wederom een harde klap voor mij, nu was immers duidelijk dat ALS erfelijk was binnen onze familie, en dit werd nog eens bevestigd doordat een genetische afwijking aangetoond kon worden bij zowel mijn vader als bij mijn tante.”*

## Deel I Genetische onderzoeken; ALS

Een kleine twintig jaar geleden werd het eerste kandidaat gen voor ALS beschreven: superoxide dismutase-1 (*SOD1*). Sinds deze veelbelovende ontdekking zijn vele andere genen in verband gebracht met ALS. In het eerste deel van dit proefschrift behandelden we elf kandidaat genen.

In **Hoofdstuk 2 en 3** bespraken we paraoxonase (*PON*), dat betrokken is bij de verwerking van giftige stoffen. Nadat gebleken was dat veteranen uit de Golf Oorlog een verhoogde kans hadden op ALS, werden veelvoorkomende variaties (polymorfismen) in *PON* nauwkeurig onderzocht. Hoewel enkele studies daadwerkelijk een verband aan konden tonen, werd dit niet bevestigd door een groot internationaal onderzoek. Wij bepaalden daarom of zeldzamere variaties (mutaties) een belangrijkere bijdrage leverden. In **Hoofdstuk 2** beschreven we de ontdekking van deze mutaties in ALS-patiënten; het daaropvolgende hoofdstuk (**Hoofdstuk 3**) werd besteed aan *PON* variaties in Nederland. We lieten zien dat *PON* mutaties aanwezig waren in 1,5% van de Nederlandse ALS-patiënten en 2,5% van controle personen, waaruit voortvloeide dat deze mutaties in Nederland niet geassocieerd zijn met ALS.



Hierna schreven we over drie recent ontdekte genen: optineurine (*OPTN*), 'valosin-containing protein' (*VCP*) en ubiquiline-2 (*UBQLN2*). *OPTN* mutaties werden in 2010 voor het eerst beschreven bij ALS-patiënten. Deze mutaties werden opgespoord door Japanse patiënten met verwante (consanguine) ouders te vergelijken, waardoor specifiek gezocht kon worden naar variaties die van beide ouders afkomstig waren (homozygote mutaties). Wij bestudeerden *OPTN* mutaties in een grote groep Nederlandse ALS-patiënten en rapporteerden twee nieuwe mutaties in patiënten zonder een duidelijke familiale component (sporadische ALS; **Hoofdstuk 4**). In het volgende hoofdstuk (**Hoofdstuk 5**) stond *VCP* centraal. *VCP* mutaties werden in ALS-patiënten aangetoond met een nieuwe techniek, 'whole-exome sequencing', waarmee alle coderende gedeeltes van het DNA onderzocht konden worden. Wij troffen *VCP* mutaties aan in een familiale- en een sporadische ALS-patiënt uit Nederland. Vervolgens gingen we in op *UBQLN2* mutaties. Deze mutaties in het X-chromosoom kwamen aan het licht in een ALS-familie waarin geen overdracht van vader op zoon plaatsvond. In **Hoofdstuk 6** screenden wij Nederlandse ALS-patiënten op *UBQLN2* mutaties en lieten zien dat deze afwezig waren. Bovenstaande hoofdstukken onderschreven dan ook de lage frequentie van mutaties in *OPTN*, *VCP* en *UBQLN2*.

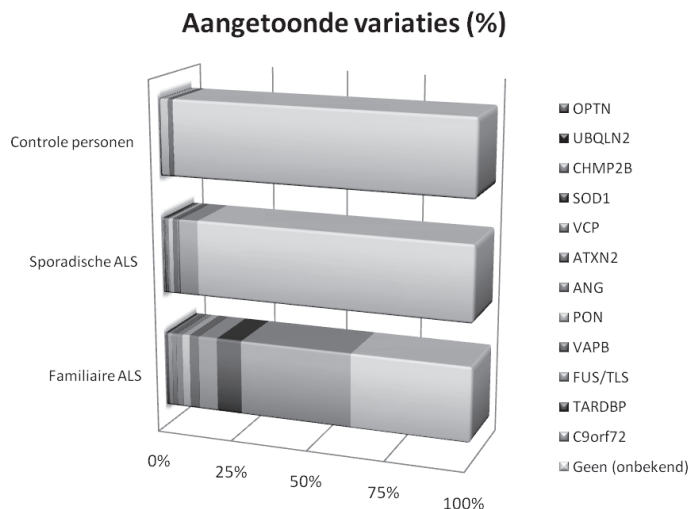
Zowel in **Hoofdstuk 7** als **8**, bespraken we genen waarvoor herhalingen van een stuk DNA kenmerkend zijn: ataxine-2 (*ATXN2*) en 'chromosome 9 open reading frame 72' (*C9orf72*). Bij *ATXN2* betreft het een verlenging van een reeks glutamines (CAG). Gezonde personen hebben meestal 22 glutamines; ALS-patiënten lijken vaker een hoger aantal glutamines te hebben. In **Hoofdstuk 7** bestudeerden wij deze aantallen in ALS-patiënten uit Nederland en België. Ons onderzoek liet inderdaad een associatie zien tussen ALS en een verhoogd aantal glutamines, zo kwamen we bij 1,1% van de familiale ALS-patiënten verhoogde aantallen tegen. Hierna bekeken we herhalingen in *C9orf72*, deze herhalingen bevinden zich in een deel van het DNA dat niet codeert voor eiwitten en wel dertig tot honderden GGGGCC's kan beslaan. Wij bepaalden deze herhalingen in Nederlandse ALS-patiënten (**Hoofdstuk 9**). In meer dan 35% van de ALS-families vonden we een verhoogd aantal GGGGCC's, waarmee *C9orf72* in Nederland de belangrijkste oorzaak van ALS op zijn conto mag schrijven.

In **Hoofdstuk 9** lag de nadruk op de complexe pathogenese van ALS. Omdat wij in veel van onze stambomen familieleden aantreffen zonder klachten maar met genetische afwijkingen, vermoedden we een combinatie van genetische factoren. Het zou bijvoorbeeld kunnen dat een specifieke mutatie alleen ALS veroorzaakt wanneer deze samengaat met een andere mutatie. Indien deze hypothese correct is, kan dit verklaren waarom familieleden met slechts één bepaalde mutatie geen ALS ontwikkelen, terwijl



hun familieleden met meerdere mutaties dit wel doen. Bovendien volgt uit deze combinatie van mutaties waarom er zo veel verschillen worden waargenomen in de klachten en het ziekteverloop van patiënten. We besloten hierom 97 ALS-families te screenen op het gelijktijdig voorkomen van mutaties in de voornaamste ALS-genen: 'TAR DNA-binding protein' (*TARDBP*), 'fused in sarcoma / translated in liposarcoma' (*FUS/TLS*), *SOD1*, angiogenine (*ANG*), en *C9orf72*. In vijf families vonden we meerdere mutaties (5,2%), wat significant meer is dan op basis van kans verwacht mag worden (p-waarde  $1,77 \times 10^{-7}$ ), waarmee onze hypothese bevestigd werd. In **Hoofdstuk 10** probeerden we meer bewijs te leveren voor onze hypothese en screenen we dezelfde groep patiënten ook op zeldzamere mutaties in 'vesicle-associated membrane protein B' (*VAPB*). We ontdekten een nieuwe *VAPB* mutatie, die bovendien aanwezig was in een patiënt met een verhoogd aantal herhalingen in *C9orf72*. Onze bevindingen ondersteunden daarmee de polygenetische hypothese.

Bovenstaande hoofdstukken beschreven elf genen, die verantwoordelijk bleken te zijn voor meer dan de helft van de ALS-families in Nederland (Figuur S.1). In **Hoofdstuk 20** werden de klinische kenmerken van geïdentificeerde patiënten gedemonstreerd. We vergeleken patiënten met mutaties in *C9orf72*, *TARDBP* en *FUS/TLS*, met de overige familiale ALS-patiënten. Hieruit kwam naar voren dat patiënten met *FUS/TLS* mutaties eerder klachten ontwikkelden en tevens een kortere levensduur vertoonden. Ook lieten we zien dat dementie vaker aangetroffen werd in families met een verhoogd aantal GGGGCC's in *C9orf72*.



**Figuur S.1** Verdeling van de aangetoonde variaties in familiale ALS-patiënten, sporadische ALS-patiënten en controle subjecten. Zie de Appendix pagina 392 voor Figuur S.1 in kleur.



*“Enige tijd later vond het eerste gesprek met de klinisch geneticus plaats. Zij heeft uitgelegd wat ALS is en in hoeverre dit erfelijk is. Aan het einde van het gesprek werd gevraagd of we wilden laten onderzoeken of wij diezelfde genetische afwijking hadden. Ik ben bij mijn standpunt gebleven en wilde echt weten of ik het gen had. Tussen het bloedprikken en de uitslag zat bijna drie maanden. “Wat nou als...” ging meerdere malen door mijn hoofd heen. Deze gedachte probeerde ik weer snel opzij te zetten, zodat ik me niet gek zou maken. Op de dag zelf werd mijn gevoel direct bevestigd: de klinisch geneticus vertelde dat ze niet zulk goed nieuws had en dat hetzelfde afwijkende gen bij mij aangetroffen was.”*

## Deel II Genetische onderzoeken; andere neurodegeneratieve aandoeningen

In het volgende deel van dit proefschrift onderzochten we genetische overeenkomsten tussen ALS en andere neurodegeneratieve aandoeningen. **Hoofdstuk 11 en 12** werden gewijd aan sporadische progressieve spinale musculaire atrofie (PSMA). Deze aandoening wordt gekenmerkt door een toenemend verlies van perifere motorische neuronen en gaat gepaard met een betere prognose dan ALS. In **Hoofdstuk 8** hadden wij reeds laten zien dat een verhoogd aantal GGGGCC's in *C9orf72* ook aanwezig kan zijn bij PSMA-patiënten. Om de genetische overlap nader te bepalen, onderzochten we de frequentie van mutaties in *SOD1*, *ANG*, *FUS/TLS* en *TARDBP* in sporadische PSMA- en ALS-patiënten (2,3% versus 1,7%). Hiernaast screenden we deze groepen op mutaties in 'multivesicular body protein 2B' (*CHMP2B*), welke voorheen beschreven werden in patiënten met PSMA. We vonden *CHMP2B* mutaties in 0,38% van de PSMA-patiënten en 0,30% van de ALS-patiënten. Ons onderzoek toonde hiermee een aanzienlijke genetische overeenkomst aan tussen PSMA en ALS.

**Hoofdstuk 13, 14 en 15** stonden voornamelijk stil bij het optreden van mutaties in *TARDBP* en *PON* bij patiënten met de ziekte van Parkinson, een van de meest voorkomende neurodegeneratieve aandoeningen. Eerder onderzoek had *TARDBP* mutaties reeds aangetoond in een klein aantal van deze patiënten, en tevens waren associaties met *PON* polymorfismen beschreven. Wij konden in Nederland echter geen aanwijzingen vinden voor een verband tussen deze genen en de ziekte van Parkinson.

*“Ik had zojuist te horen gekregen dat ik een hogere kans heb op ALS. ‘s Avonds hebben mijn vriend en ik er voor het eerst samen over gesproken, deze uitslag betekent namelijk ook dat onze kinderen later 50% kans hebben het gen te erven. Dit is een behoorlijk percentage: wat nu? Onze kinderwens is groot maar we willen niet dat onze kinderen dit gen erven.”*

### Deel III Functionele onderzoeken

In het laatste deel van dit proefschrift lag de nadruk op de functionele gevolgen van de besproken mutaties. In **Hoofdstuk 16** gaven we een overzicht van zes ALS-genen en beschreven we hun ontdekking, functies en overeenkomsten. Hieruit kwam hun essentiële rol in de verwerking van RNA prominent naar voren. **Hoofdstuk 17** bracht de normale functie en aangrijpingspunten van FUS/TLS verder in kaart. We maakten hiervoor gebruik van een celkweekmodel en RNA-Seq, een innovatieve nieuwe techniek. Zodoende konden we aantonen dat FUS/TLS voornamelijk invloed heeft op genen die betrokken zijn bij de opbouw van eiwitten (ribosomale genen) en bij het splitsen van RNA (RNA 'splicing').

In **Hoofdstuk 17 en 18** maakten we gebruik van 'Enzyme-Linked Immuno Sorbent Assays' (ELISA's). Hiermee bepaalden we de plasma spiegels van het eiwit dat gecodeerd wordt door *TARDBP*: TDP-43 (**Hoofdstuk 17**). ALS-patiënten bleken significant hogere TDP-43 spiegels te vertonen dan controle personen, wat aangeeft dat deze spiegels mogelijk gebruikt kunnen worden om het stellen van de diagnose en het ontwikkelen van nieuwe medicijnen te vergemakkelijken. In het volgende hoofdstuk, **Hoofdstuk 19**, gingen we terug naar de bron: SOD1. We ontwikkelden een ELISA om antistoffen tegen SOD1 te detecteren, zowel tegen de normale vorm van SOD1 als tegen de veranderde vorm, als model voor gemuteerd SOD1. In vijf tot tien procent van de sporadische ALS-patiënten, konden we verhoogde spiegels aantonen. Bovendien zagen we dat patiënten met IgM antistoffen tegen veranderd SOD1 een verlengde levensduur hadden, wat onderschrijft dat deze antistoffen een beschermend effect lijken te hebben. Aan de andere kant vertoonden patiënten met IgG antistoffen tegen de normale vorm van SOD1 een verkorte levensduur, hetgeen mogelijk verklaard kan worden doordat ze de anti-oxidatieve functie van SOD1 beperken en daarmee neurologische schade berokkenen. Ons onderzoek schetst hiermee een nieuw immunotherapeutisch aangrijpingspunt voor ALS.



*“Ik zou andere mensen (in een soortgelijke situatie) aanraden zich ook te laten testen. Hiermee draag je niet alleen bij aan de wetenschap, je kunt voor jezelf ook verstandige keuzes maken; al begrijp ik natuurlijk dat een negatieve uitslag je leven ook op zijn kop kan zetten.”*

Ten slotte, hebben we in **Hoofdstuk 20** onze bevindingen samengevat en bediscussieerd. We hebben daarmee de Nederlandse ALS-populatie kunnen karakteriseren en tevens een uitvoerig overzicht geboden van de genetische afwijkingen die kunnen leiden tot ALS. Verder hebben we getracht verlichting te verschaffen door verbanden aan te dragen. Zo beschreven we hoe mutaties in *OPTN*, *VCP*, *UBQLN2* en *VAPB* de afbraak van eiwitten verstoren, waardoor eiwitten zich ophopen. Ook verwoordden we hoe herhalingen in *ATXN2* en *C9orf72* kunnen zorgen voor een samenklontering van misvormd RNA dat allerlei RNA-bindende eiwitten aantrekt. Eveneens gaven we aan hoe mutaties in *SOD1* en *PON* oxidatieve stress veroorzaken, en dat *SOD1* ook gevoelig is voor samenklontering. Daarnaast schreven we hoe TDP-43 en FUS/TLS aangetoond kunnen worden in een behoorlijk percentage van deze ophopingen, en hoe gemuteerde vormen van deze eiwitten de verwerking van RNA ontwrichten. ANG, op zijn beurt, lijkt met name de kwetsbaarheid van neuronen te vergroten, waardoor ze gevoeliger zijn voor ALS. Dit zeer complexe samenspel zorgt voor een cruciale samenklontering van eiwitten, waardoor fundamentele cellulaire processen verstoord raken. Uiteindelijk resulteert dit in het afsterven van motorische neuronen en dientengevolge in het ontstaan van ALS.

*“ALS speelt een grote rol in mijn leven. Ik probeer zelf onder andere via de sociale media meer bekendheid aan ALS te geven. Er is namelijk hard geld nodig voor onderzoek en voor de ontwikkeling van een (eventueel genezend) medicijn. Ik hoop op een dag te horen dat er een medicijn is uitgevonden tegen ALS, en hoop van harte dat mijn vader en tante deze dag mee mogen maken.”*



**“Leef honderd jaar en lach in uw vuistje,  
niet alleen om alle artsen, maar ook  
om de rest van de wereld.”**

Voltaire en de Republiek.

## **Dankwoord (Acknowledgements)**

Het overbrengen van dankbetuigingen is een schone zaak, één die ik niet geheel onbenut voorbij zou willen laten gaan. In de eerste plaats ben ik mijn ouders, Clemens en Ellen, en mijn zus, Michelle, veel dank verschuldigd. Zittend in het hooi, naast me een vergiet vol met vers geplukte bramen, op mijn schoot een spinnende poes; zo bracht ik als kind maar al te graag mijn tijd door, werkend aan mijn verhalen. Het was een jeugd die alle ruimte bood aan fantasie, zonder de werkelijkheid uit het oog te verliezen. Nooit was ik eenzaam of alleen, altijd was er plek voor sportieve uitdagingen en fanatieke discussies met een wetenschappelijke basis. Ik had me geen jeugd kunnen wensen die stimulerender was geweest.

Tevens ben ik mijn oma Ine buitengewoon erkentelijk. Haar tomeloze energie, haar gedrevenheid, en haar intelligentie vormen een grote bron van inspiratie. Nimmer vergeet ik die warme vrijdagen overladen met vertellingen, strijkgoed en fruitjes. Uiteraard ben ik eveneens mijn opa Henk ontzettend dankbaar. De andere kant van de wereld ligt helaas niet om de hoek, maar ik heb altijd terug kunnen vallen op zijn excellente advies en zijn voorbeeld, ook als arts.

Ik zou met name prof.dr. Siddharthan Chandran en dr. Dan Webber willen danken voor het voeden van mijn wetenschappelijke bevoegdheid. Werken in hun innovatieve laboratorium gelegen in het pittoreske Cambridge (Verenigd Koninkrijk) opende nieuwe deuren. Bruisend van enthousiasme kwam ik vervolgens aan in het zeer gerespecteerde laboratorium van prof.dr. Bob Brown, dr. John Landers en dr. Daryl Bosco in Boston/Worcester (Verenigde Staten). Ik stel het zeer op prijs dat ze mij een kijk in de keuken van hun echte toplaboratorium gunden. Vanzelfsprekend wil ik evengoed het Fulbright Center en VSBfonds danken voor hun waardevolle bijdrage.

Na mijn terugkeer naar Nederland, was ik oprecht vereerd me aan te mogen sluiten bij de groep van prof.dr. Leonard van den Berg. Bovendien was ik verheugd het succesvolle onderzoek van dr. Michael van Es over te kunnen nemen. Mede door de expertise van dr. Jan Veldink, wisten we dit proefschrift in grofweg 2,5 jaar te bewerkstelligen. Hierbij zou ik Leonard, Michael en Jan dan ook royaal willen bedanken. Daarnaast zou ik dank willen betuigen aan mijn collega's; hun assistentie, gesprekken en suggesties heb ik ontegenzeggelijk gewaardeerd.

Regelmatig was ik, gedurende mijn onderzoek, aan te treffen op de polikliniek Neuro-musculaire ziekten. Ik had daar voornamelijk contact met families waarin de erfelijke vorm van amyotrofische laterale sclerose (familiaire ALS) voorkwam: ik heb ongelofelijk veel bewondering voor hun moed en hun strijdvaardigheid. Graag wil ik bovenal de families bedanken die deel hebben willen nemen aan het onderzoek naar familiale



ALS. Dankzij hun hulp hebben we een grote sprong kunnen maken, waardoor we vele oorzaken op hebben kunnen sporen. In het bijzonder erken ik de bijdrage van de twee personen die mij uitvoerig hun verhaal deden en op lieten nemen in dit proefschrift, hun woorden leverden een indrukwekkende beschrijving op van deze slopende aandoening. Verder wil ik Nynke bedanken voor haar onuitputtelijke bijstand op de polikliniek, welke echt onmisbaar was. Ook de priksters die zonder blikken of blozen telkens meer dan tien buizen bloed af wisten te nemen, zowel op de polikliniek als op locatie, apprecieer ik zeer. Hiernaast zou ik het DNA-diagnostiek laboratorium willen danken voor hun nauwkeurige verwerking van de overvloedige hoeveelheid patiëntenmateriaal. De organisatorische kwaliteiten van Petra en Hermieneke kan ik net zo min onbenoemd laten, evenals alle prijzingswaardige hulp van de analisten: Peter, Jelena en Raymond. Voorts zou ik het belangrijke speurwerk van Eric en Dennis willen benadrukken, net als de goede genetische voorlichting van dr. Eva Brilstra. Tevens zou ik prof.dr. Marianne de Visser, dr. Anneke van der Kooi, dr. Jurgen Schelhaas, dr. Bart van de Warrenburg en dr. Dagmar Verbaan willen danken voor hun kritische revisie van mijn manuscripten en/of het delen van hun materiaal en hun klinische informatie. Insgelijks ben ik de leden van mijn beoordelingscommissie dankbaar voor het vellen van hun deskundige oordeel over deze, toch enigszins excessieve, bundel.

Dit proefschrift was niet tot stand gekomen zonder een uitlaatklep in de vorm van atletiek. Ik wil Fred daarom uiterst danken voor zijn vertrouwen, zijn geduld, en zijn geweldige trainingen en schema's. Tevens wil ik mijn waardering uitspreken voor de steun van Carlien en alle lopers van het 'Hellas Distance Running Team' (HDRT). Zonder hen waren bovendien die honderden kilometers in de week en die verrassende marathon onder de drie uur nooit gerealiseerd.

Gaarne zou ik ook mijn paranimfen, Douwe en Djoelia, willen danken. Ik vind het een grote eer dat zij het stokje van hun vaders over hebben willen nemen en hoop van harte dat we dit nog vele generaties mogen blijven doen.

Tot slot, zou ik al mijn familieleden, vrienden, collega's en deelnemers (nogmaals) willen bedanken en wens ik hen allen een leven toe zoals Voltaire dat prachtig wist te vangen.



**“There is no more fruitful exercise than attempting to know ourselves. I believe that we would have been able to find many very reliable rules, both for curing illness and for preventing it, if only we had spent enough effort on getting to know the nature of our body.”**

The Philosophical Writings of Descartes.

## About the author

## Curriculum vitae

Marka van Blitterswijk was born on April 5<sup>th</sup>, 1984 in Delft. In 2002, she graduated (cum laude) at the St.- Antonius College in Gouda. Hereafter, she started medical school at the University of Utrecht, and acquired her 'Propedeuse' degree (cum laude) in 2003. As part of her medical training, she worked on multiple research projects in The Netherlands and abroad. After successfully finishing her project on periventricular leukomalacia (PVL) with Prof. Dr. Siddharthan Chandran at the Brain Repair Center (Cambridge, United Kingdom), she obtained her 'Doctoraal' degree in 2008, with an average of 8.4 for all courses/clerkships.

Subsequently, she was proud to receive a Fulbright grant and VSBfonds grant to work on familial and sporadic amyotrophic lateral sclerosis (ALS) in the esteemed group of Prof. Dr. Bob Brown (Harvard Medical School, Boston/University of Massachusetts, Worcester, United States of America). In 2009, she returned to The Netherlands and started her PhD program on familial ALS in the respected group of Prof. Dr. Leonard van den Berg, which led to this thesis.

In Spring 2012, she will start as post-doctoral researcher in the praised group of Dr. Rosa Rademakers at the Mayo Clinic Florida (Jacksonville, United States of America) to further investigate the role of chromosome 9 open reading frame 72 (*C9orf72*) in the pathogenesis of ALS.

## Publications

- (1) Ticozzi N, Leclerc AL, Keagle P, Glass JD, Wills AM, van Blitterswijk M, Bosco DA, Rodriguez-Leyva I, Gellera C, Ratti A, Taroni F, McKenna-Yasek DM, Sapp PC, Silani V, Furlong CE, Brown RH Jr., Landers JE. Paraoxonase gene mutations in amyotrophic lateral sclerosis. *Ann Neurol* 2010;68:102-107.
- (2) Van Es MA, Schelhaas HJ, van Vught PWJ, Ticozzi N, Andersen PM, Groen EJM, Schulte C, Blauw HM, Koppers M, Diekstra FP, Fumoto K, LeClerc AL, Keagle P, Bloem BR, Scheffer H, van Nuenen BFL, van Blitterswijk M, van Rheenen W, Wills A, Lowe PP, Hu G, Yu W, Kishikawa H, Wu D, Folkerth RD, Mariani C, Goldwurm S, Pezzoli G, van Damme P, Lemmens R, Dahlberg C, Birve A, Fernández-Santiago R, Waibel S, Klein C, Weber M, van der Kooi AJ, de Visser M, Verbaan D, van Hilten JJ, Heutink P, Hennekam EAM, Cuppen E, Berg D, Brown RH Jr., Silani V, Gasser T, Ludolph AC, Robberecht W, Ophoff RA, Veldink JH, Pasterkamp RJ, de Bakker PIW, Landers JE, van de Warrenburg BP, van den Berg LH. Angiogenin variants in Parkinson's disease and amyotrophic lateral sclerosis. *Ann Neurol* 2011;70:964-973.
- (3) Van Damme P\*, Veldink JH\*, van Blitterswijk M\*, Corveleyn A, van Vught PWJ, Thijs VN, Dubois B, Matthijs G, van den Berg LH#, Robberecht W#. Expanded ATXN2 CAG repeat size in ALS identifies genetic overlap between ALS and SCA2. *Neurology* 2011;76:2066-2072.
- (4) Van Rheenen W, van Blitterswijk M, Huisman MHB, Vlam L, van Doormaal PTC, Seelen M, Medic J, Dooijes D, de Visser M, van der Kooi AJ, Raaphorst J, Schelhaas HJ, van der Pol WL, Veldink JH#, van den Berg LH#. Hexanucleotide repeat expansions in C9orf72 in the spectrum of motor neuron diseases. *Neurology* 2012 {in press}.
- (5) Vlam L, Schelhaas HJ, van Blitterswijk M, van Vught PWJ, de Visser M, van der Kooi AJ, van der Pol WL, van den Berg LH. Mutations in the TRPV4 gene are not associated with sporadic progressive muscular atrophy. *Arch Neurol* 2012 {in press}.
- (6) Van Blitterswijk M, van Vught PWJ, van Es MA, Schelhaas HJ, van der Kooi AJ, de Visser M, Veldink JH#, van den Berg LH#. Novel optineurin mutations in sporadic amyotrophic lateral sclerosis patients. *Neurobiol Aging* 2011 Jul 27.
- (7) Ticozzi N, Leclerc AL, van Blitterswijk M, Keagle P, McKenna-Yasek DM, Sapp PC, Silani V, Wills AM, Brown RH Jr., Landers JE. Mutational analysis of TARDBP in neurodegenerative diseases. *Neurobiol Aging* 2010;68:102-107.



- (8) Koppers M, van Blitterswijk M, Vlam L, Rowicka PA, van Vught PWJ, Groen EJM, Spliet WGM, Engelen-Lee J, Schelhaas HJ, de Visser M, van der Kooi AJ, van der Pol WL, Pasterkamp RJ, Veldink JH<sup>#</sup>, van den Berg LH<sup>#</sup>. VCP mutations in familial and sporadic amyotrophic lateral sclerosis. *Neurobiol Aging* 2011 Nov 9.
- (9) Van Blitterswijk M, Blokhuis A, van Es MA, van Vught PWJ, Rowicka PA, Schelhaas HJ, van der Kooi AJ, de Visser M, Veldink JH<sup>#</sup>, van den Berg LH<sup>#</sup>. Rare and common paraoxonase gene variants in amyotrophic lateral sclerosis patients. *Neurobiol Aging* 2012 Feb 11.
- (10) Van Doormaal PTC, van Rheenen W, van Blitterswijk M, Schellevis RD, Schelhaas HJ, de Visser M, van der Kooi AJ, Veldink JH<sup>#</sup>, van den Berg LH<sup>#</sup>. UBQLN2 in familial amyotrophic lateral sclerosis in the Netherlands. *Neurobiol Aging* 2012 {in press}.
- (11) Webber DJ<sup>\*</sup>, van Blitterswijk M<sup>\*</sup>, Chandran S. Neuroprotective effect of oligodendrocyte precursor cell transplantation in a long-term model of periventricular leukomalacia. *Am J Pathol* 2009;175:2332-2342.
- (12) Van Blitterswijk M, Landers JE. RNA processing pathways in amyotrophic lateral sclerosis. *Neurogenetics* 2010;11:275-289.
- (13) Van Blitterswijk M, Gulati S, Smoot E, Jaffa M, Maher N, Hyman BT, Iverson AJ, Scherzer CR, Schoenfeld DA, Cudkovicz ME, Brown RH Jr., Bosco DA. Anti-superoxide dismutase antibodies are associated with survival in patients with sporadic amyotrophic lateral sclerosis. *Amyotroph Lateral Scler* 2011;12:430-438.

## Submitted / in preparation

- (14) Van Blitterswijk M, Wang ET, Friedman BA, Keagle PJ, Lowe P, Leclerc AL, van den Berg LH, Housman DE, Veldink JH<sup>#</sup>, Landers JE<sup>#</sup>. Characterization of FUS/TLS mutations in amyotrophic lateral sclerosis using RNA-Seq.
- (15) Van Blitterswijk M, van Es MA, Hennekam EAM, Dooijes D, van Rheenen W, Medic J, Bourque PR, Schelhaas HJ, van der Kooi AJ, de Visser M, de Bakker PIW, Veldink JH, van den Berg LH. Evidence for a polygenic basis of amyotrophic lateral sclerosis.
- (16) Van Blitterswijk M, Vlam L, van Es MA, van der Pol WL, Hennekam EAM, Dooijes D, Schelhaas HJ, van der Kooi AJ, de Visser M, Veldink JH<sup>#</sup>, van den Berg LH<sup>#</sup>. Genetic overlap between apparently sporadic motor neuron diseases.

- (17) Van Blitterswijk M, van Es MA, Koppers M, van Rheenen W, Medic J, Schelhaas HJ, van der Kooi AJ, de Visser M, Veldink JH, van den Berg LH. VAPB and C9orf72 mutations in one familial amyotrophic lateral sclerosis patient.
- (18) Verstraete E\*, Kuiperij HB\*, van Blitterswijk M, Veldink JH, Schelhaas HJ, van den Berg LH#, Verbeek MM#. TDP-43 plasma levels: a biomarker for amyotrophic lateral sclerosis?
- (19) Van Blitterswijk M, Blokhuis A, Keagle PJ, Leclerc AL, van Es MA, Rowicka PA, Verbaan D, van Hilten JJ, Scheffer H, van de Warrenburg BP, Veldink JH#, van den Berg LH#, Landers JE. Paraoxonase gene mutations are not associated with Parkinson's disease.
- (20) Van Blitterswijk M, van Es MA, Verbaan D, van Hilten JJ, Scheffer H, van de Warrenburg BP, Veldink JH#, van den Berg LH#. Mutational analysis of TARDBP in Parkinson's disease.

\* # Authors contributed equally

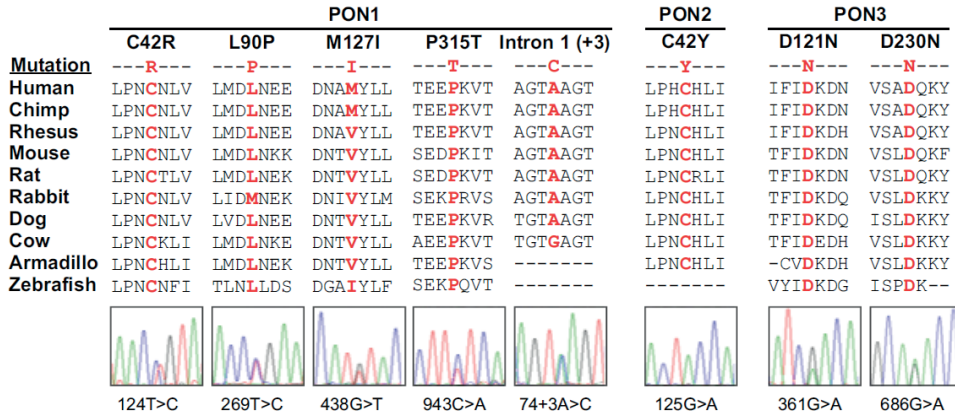


**“Tot kunsten en wetenschappen wil ik mij keren en zoveel ik maar kan daarin door blijven leren, want niemand wordt deskundig geboren. Maar geleerden en kunstenaars moeten het wel deren dat de domme knoeiers het vak niet eren.”**

Mariken van Nieuweghen.



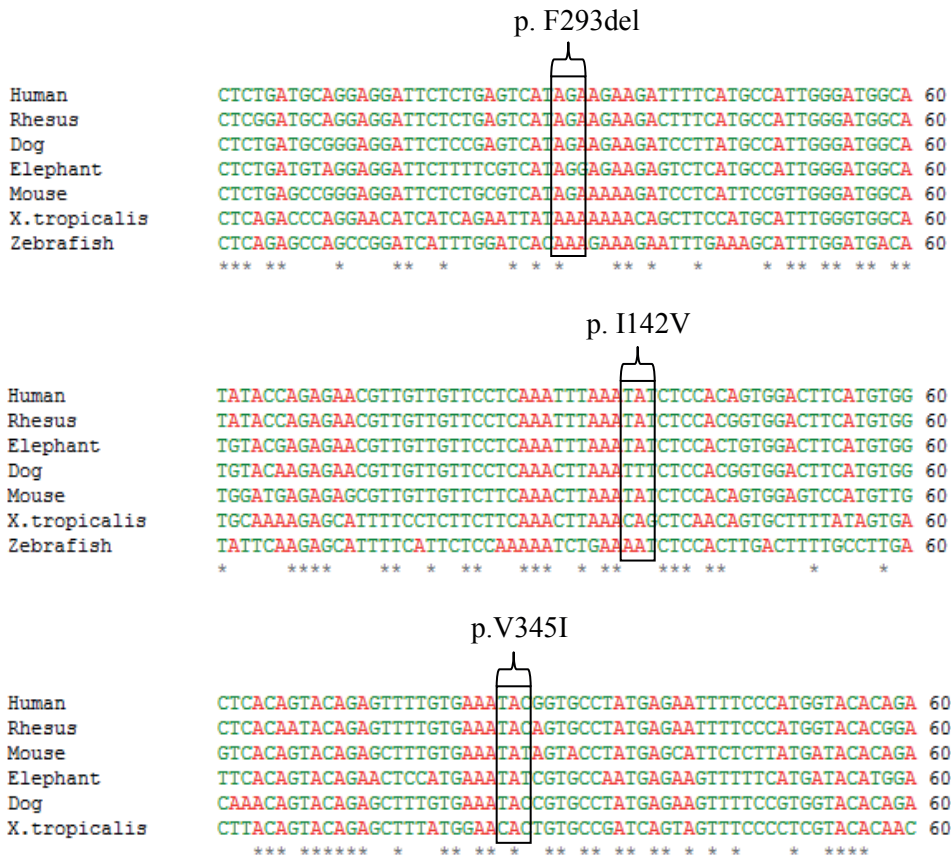
## Appendix



**Figure 2.1** Evolutionary conservation of *PON* mutations in familial and sporadic amyotrophic lateral sclerosis. This illustrates the evolutionary conservation of the amino acids implicated by the eight identified mutations. For each, the mutated amino acid (or nucleotide for the splicing mutation) is shown in red. Chromatograms displaying the mutation are shown below. The position indicates the base pair position within the cDNA. All mutations were heterozygous except for the homozygous p.C42Y *PON2* mutation. Each mutation was confirmed by bi-directional sequencing and 5' nuclease assay genotyping.

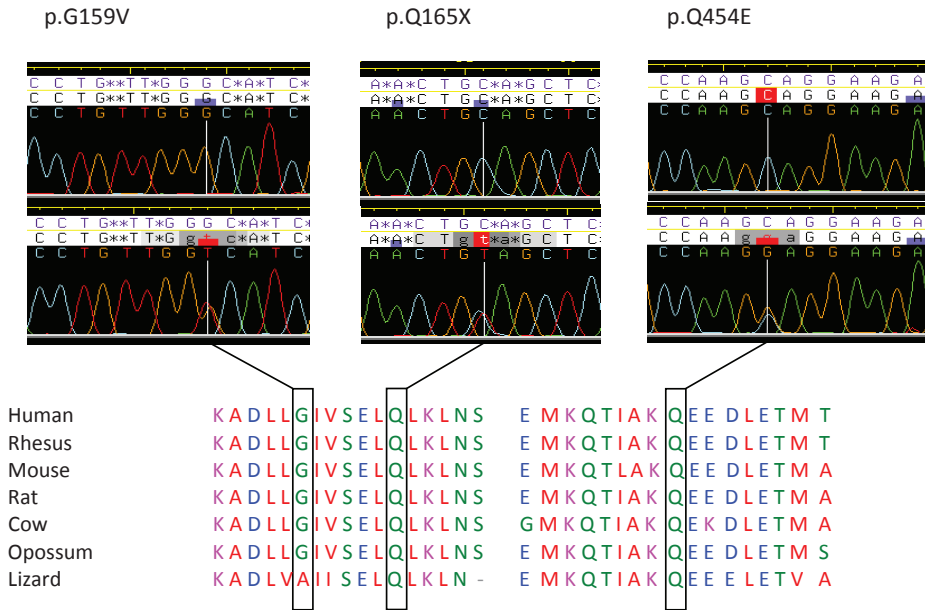
| Variant   | PON1    |         |         |
|-----------|---------|---------|---------|
|           | N19D    | M127R   | A201V   |
|           | ---D--- | ---R--- | ---V--- |
| Human     | LFRNHQS | DNAMYLL | LGLAWSY |
| Chimp     | LFRNHQS | DNAMYLL | LGLAWSY |
| Rhesus    | LFKNHQF | DNAVYLL | LGLAWSY |
| Mouse     | LYKNHRS | DNTVYLL | LGLPWSN |
| Rat       | LFRNHRS | DNTVYLL | LGLPWSN |
| Rabbit    | LFDGQKS | DNIVYLM | LGLAWSF |
| Dog       | LFRDHRA | DNTVYLL | LGLAWSY |
| Cow       | FFRDYRS | DNTVYLL | LGLAWSN |
| Armadillo | VFRDRRS | DNTVYLL | LGLAWSY |
| Zebrafish | -----   | DGAIYLF | FSLPWCD |

**Supplementary Figure 2.1** Evolutionary conservation of *PON1* variants found in ALS and controls. This illustrates the evolutionary conservation of the amino acids implicated by the three variants identified in both cases and controls. For each, the variant residue is shown in red.

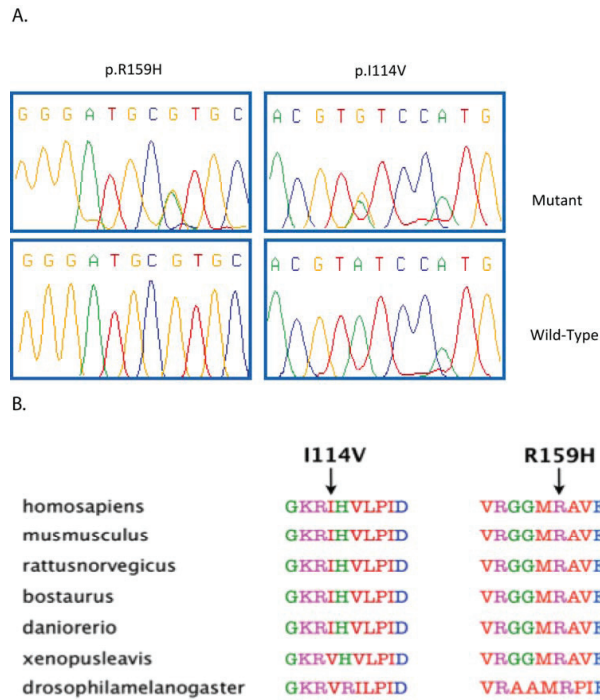


**Supplementary Figure 3.1** Evolutionary conservation of *PON* mutations unique for ALS patients. Conservation of nucleotides across species was generated using ClustalW2 online tool, <http://www.ebi.ac.uk/Tools/msa/clustalw2/>.

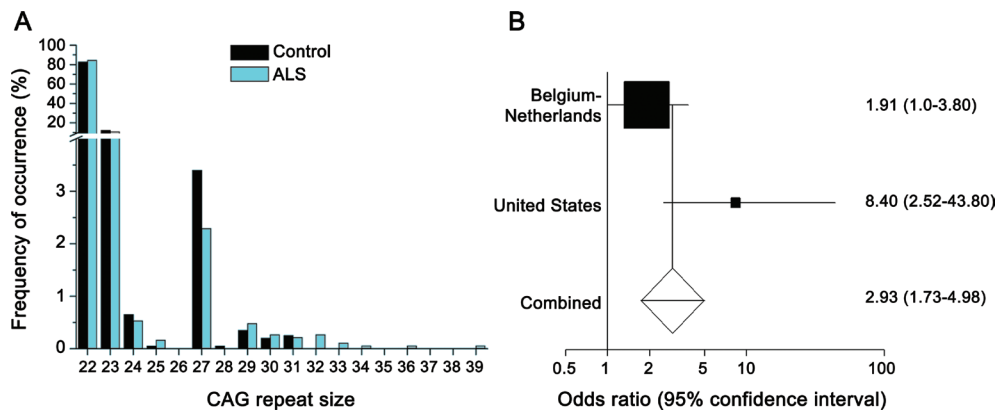




**Figure 4.1** *OPTN* mutations and conservation. Conservation of amino acid residues across species was generated using ClustalW2 online tool, <http://www.ebi.ac.uk/Tools/msa/clustalw2/>.



**Figure 5.1** A. Chromatograms of wild-type and mutant alleles found in one FALS (p.R159H) and one SALS (p.I114V) patient. B. Conservation analysis of the mutated amino acids amongst several species using ClustalW2 (<http://www.ebi.ac.uk/Tools/msa/clustalw2/>).



**Figure 7.1** Expanded CAG repeats in *ATXN2* in sporadic ALS. A) Distribution of CAG repeat sizes of the allele with the longest repeat in ALS patients and controls. B) Meta-analysis of the effect of CAG repeat sizes in ALS, a repeat size of 29 or higher was used as cut-off for analysis.



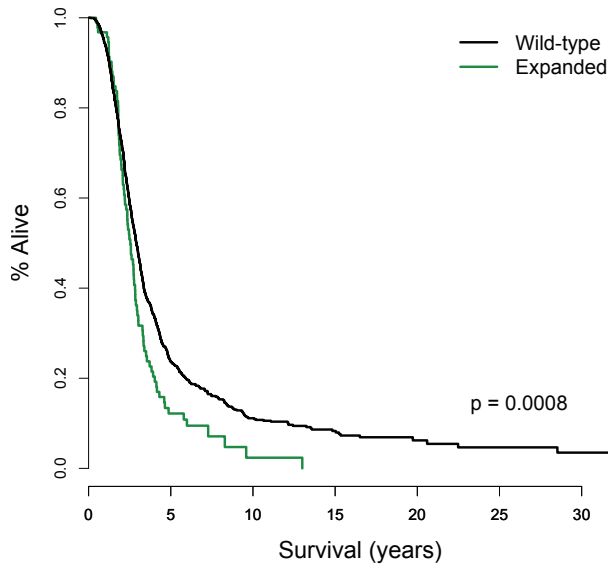
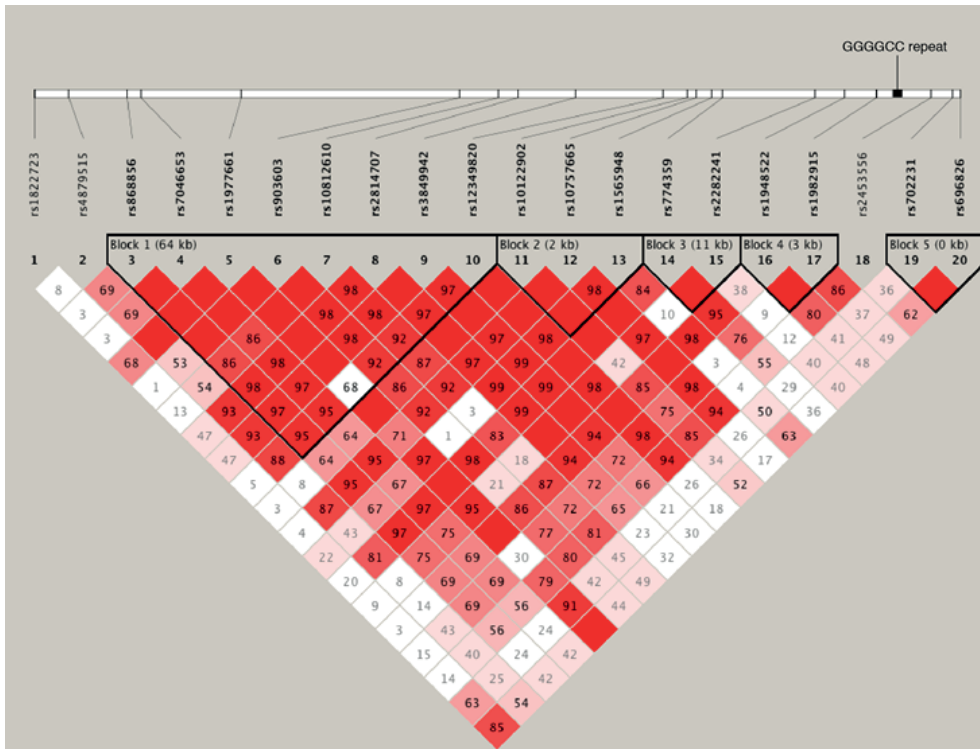
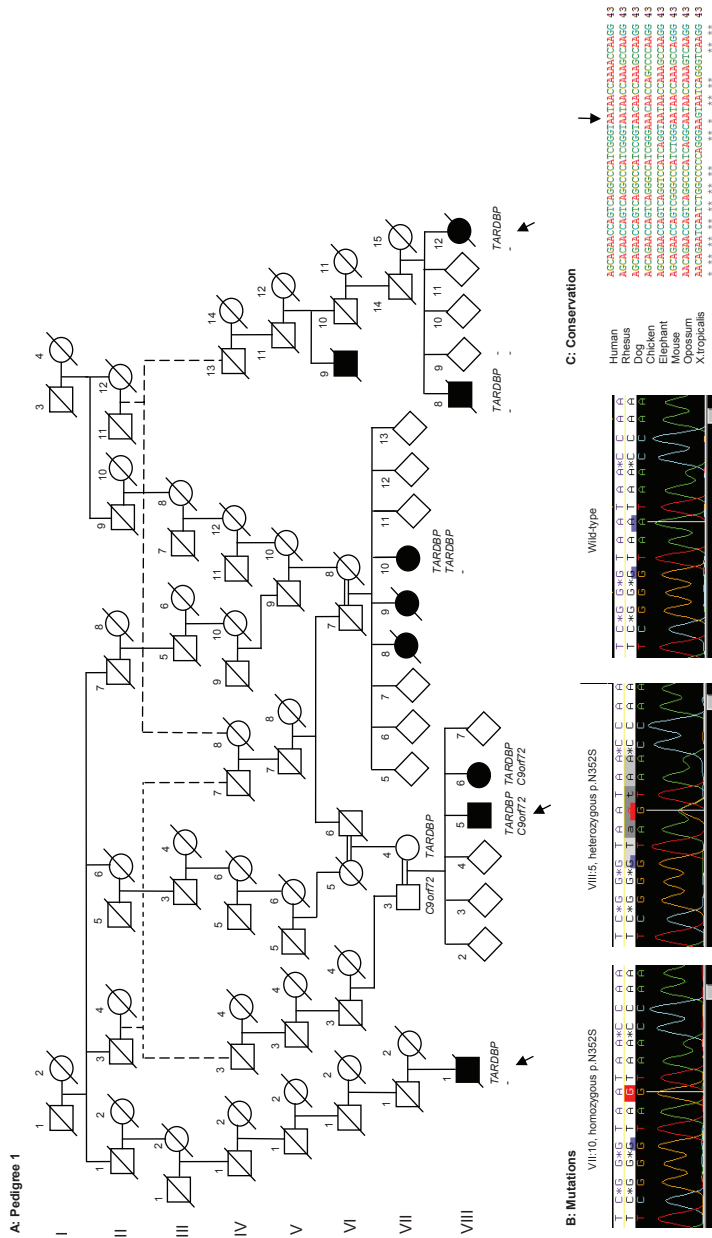


Figure 8.1 Survival for *C9orf72* repeat genotype.



Supplementary Figure 8.1 Haplotype blocks.

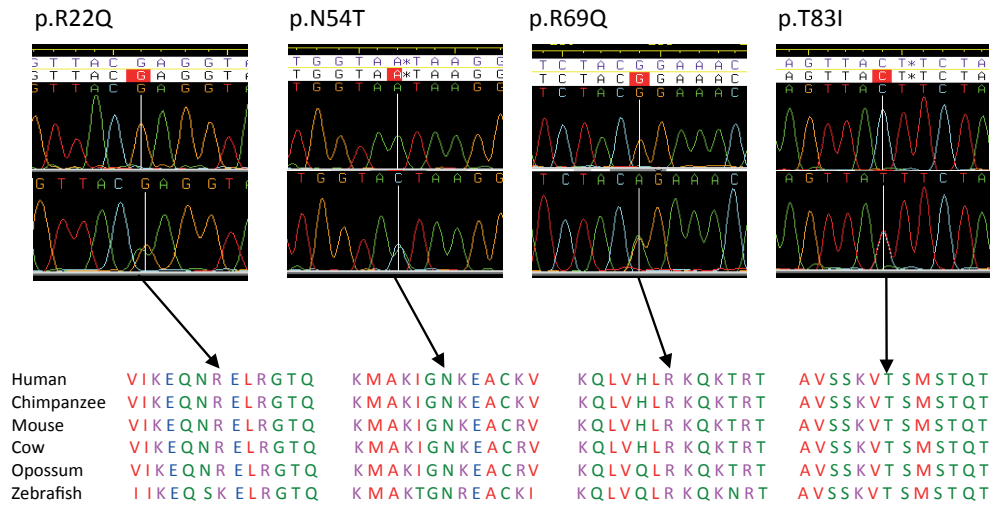


**Figure 9.1** Pedigree 1 with *TARDBP* (p.N352S) mutation. A: Screened individuals with a *TARDBP* mutation (p.N352S) are marked with '*TARDBP*'. Individuals with *C9orf72* repeat expansions are marked with '*C9orf72*', and individuals without these mutations are marked with '-'. B: We show the homozygous p.N352S mutation without a *C9orf72* repeat expansion of patient VIII:10. In addition, we display the heterozygous p.N352S mutation and the *C9orf72* repeat expansion of patient VIII:5. C: Conservation of amino-acid residues across species was generated using ClustalW2 online tool, <http://www.ebi.ac.uk/Tools/msa/clustalw2/>.



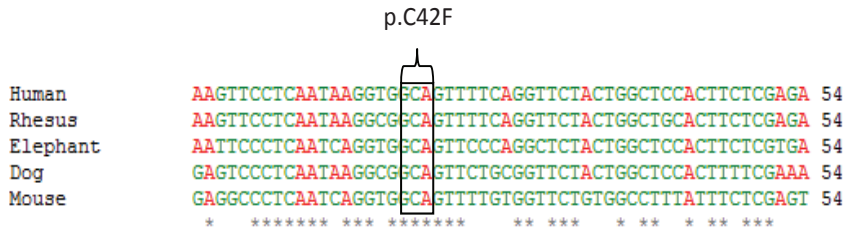
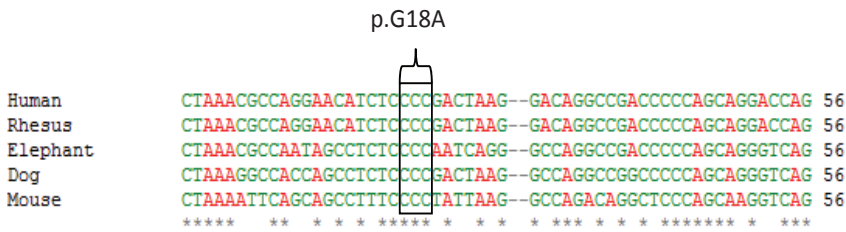




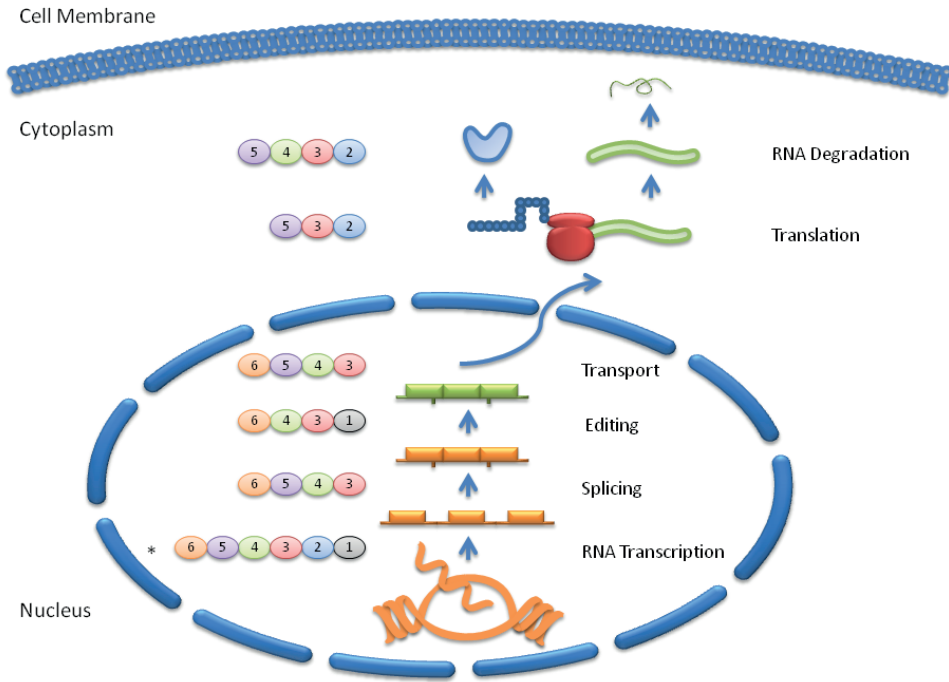


**Supplementary Figure 11.1** *CHMP2B* mutations and conservation. Conservation of amino acid residues across species was generated using ClustalW2 online tool, <http://www.ebi.ac.uk/Tools/msa/clustalw2/>.





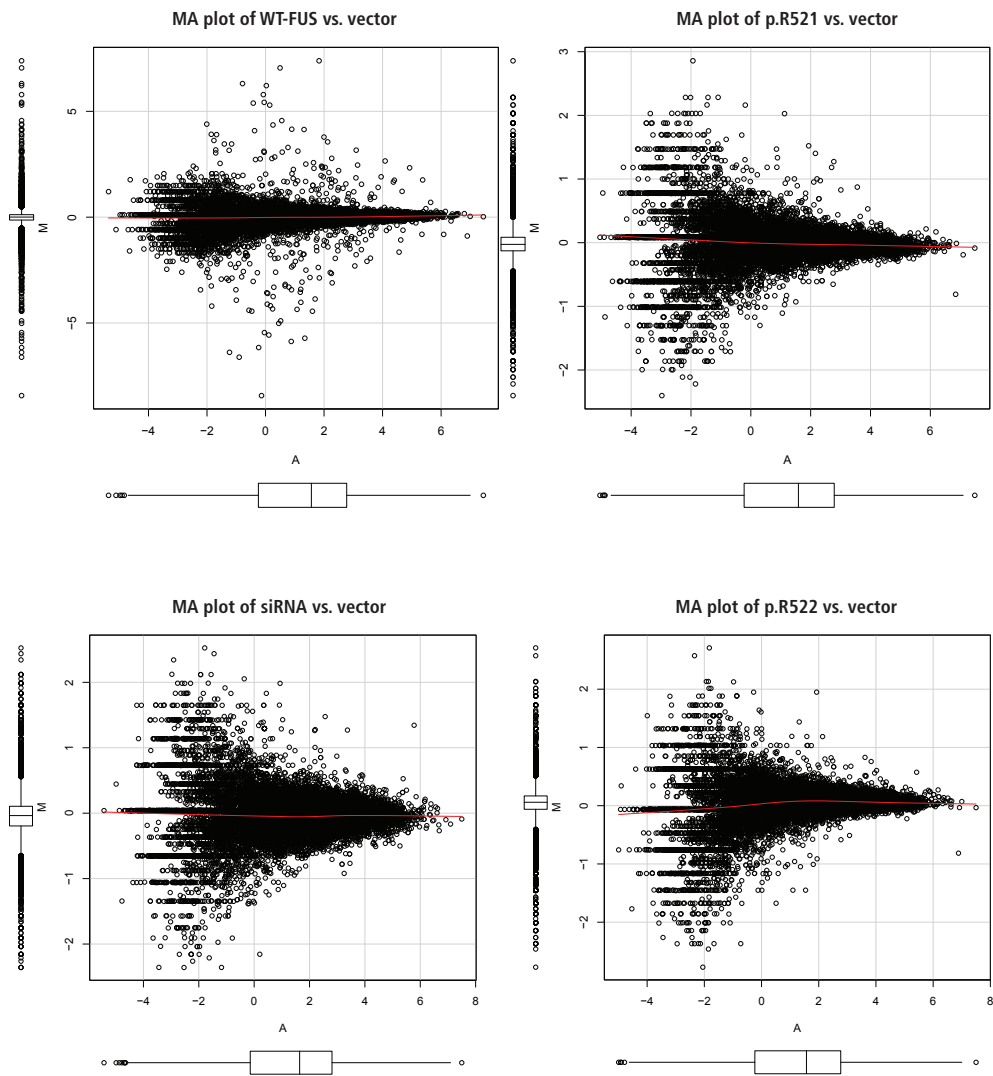
**Figure 15.1** Evolutionary conservation of *PON* mutations unique for PD patients. Conservation of nucleotides across species was generated using ClustalW2 online tool, <http://www.ebi.ac.uk/Tools/msa/clustalw2/>.



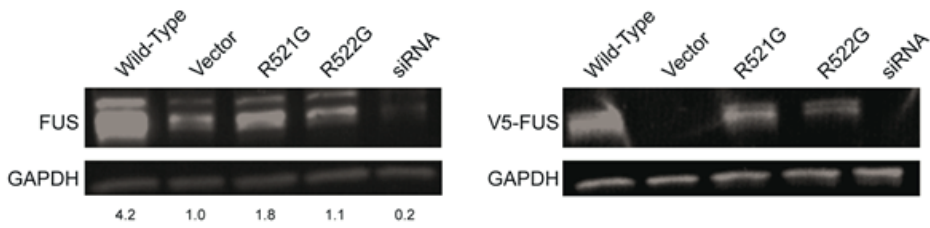
\* ELP3=1, ANG=2, SETX=3, SMN=4, TDP-43=5 and FUS/TLS=6

**Figure 16.1** ALS-related genes in the RNA processing pathway.

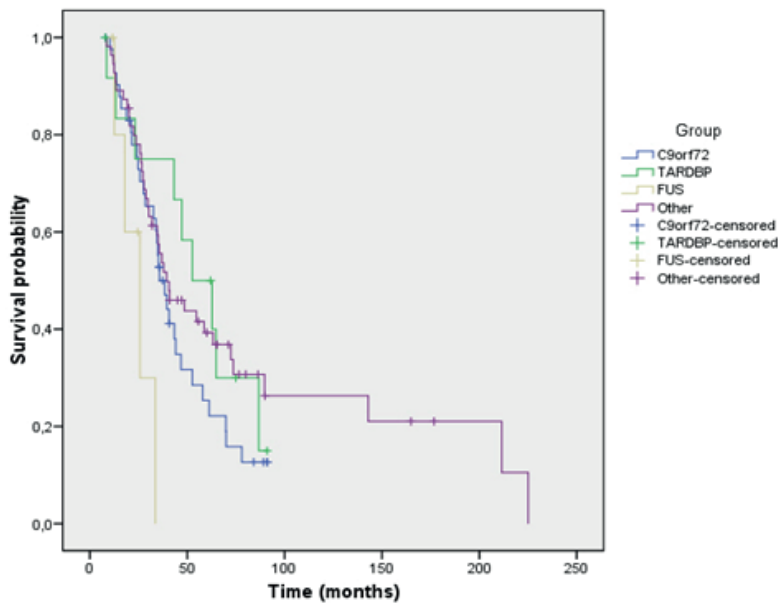




**Supplementary Figure 17.1** MA plots per condition comparison. MA plots per comparison where  $M = \log(\text{rpkm}_{\text{condition}}) - \log(\text{rpkm}_{\text{vector}})$  and  $A = 0.5 * (\log(\text{rpkm}_{\text{condition}}) + \log(\text{rpkm}_{\text{vector}}))$ .

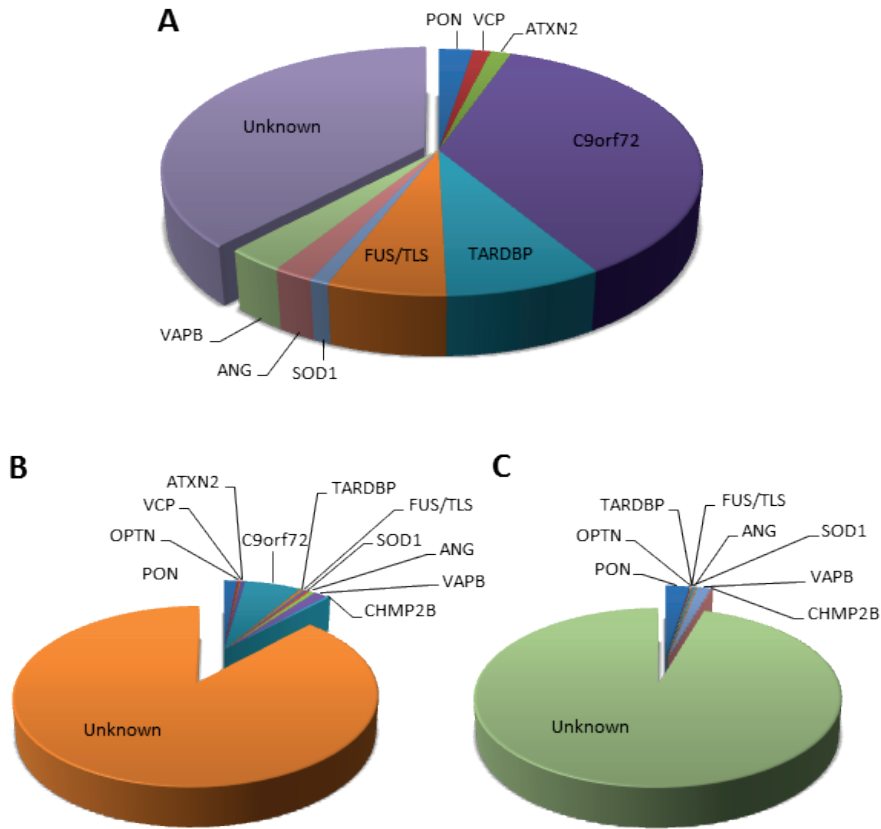


**Supplementary Figure 17.3** FUS/TLS protein levels measured by Western blot. We performed quantitative Western blot analysis and demonstrated siRNA caused a decrease in the *FUS/TLS* expression, whereas transfections with wild type *FUS/TLS* and the two mutants caused an increase in the *FUS/TLS* expression. Antibodies against FUS/TLS and the V5-tag were used (Materials and methods).

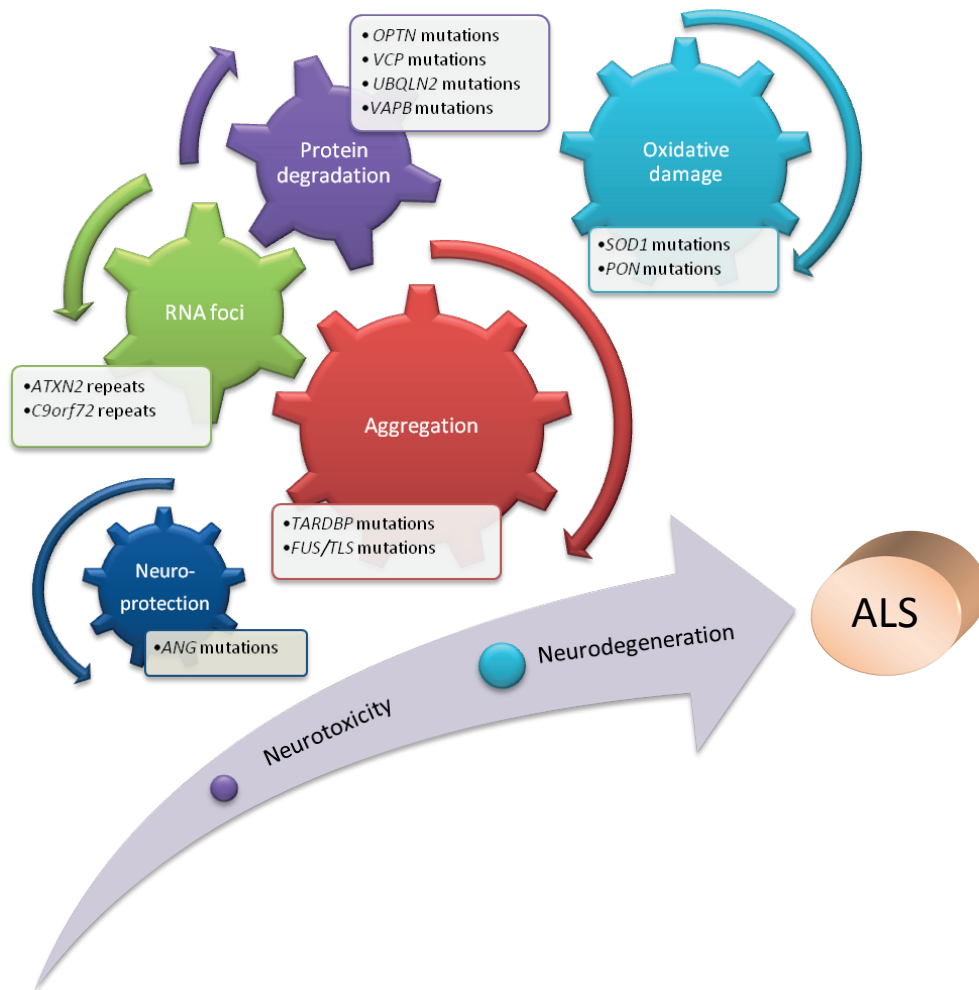


**Figure 20.1** Survival of FALS patients. Patients with *C9orf72*, *TARDBP* and *FUS/TLS* mutations, were compared to patients with other mutations. A Cox proportional hazards model was used, which corrected for gender, age at onset and site of onset (R v2.10 software [www.r-project.org]). The survival of patient with *FUS/TLS* mutations was significantly reduced (p-value 0.001, hazard ratio 6.5 [confidence interval [CI] 2.1-20.3]).



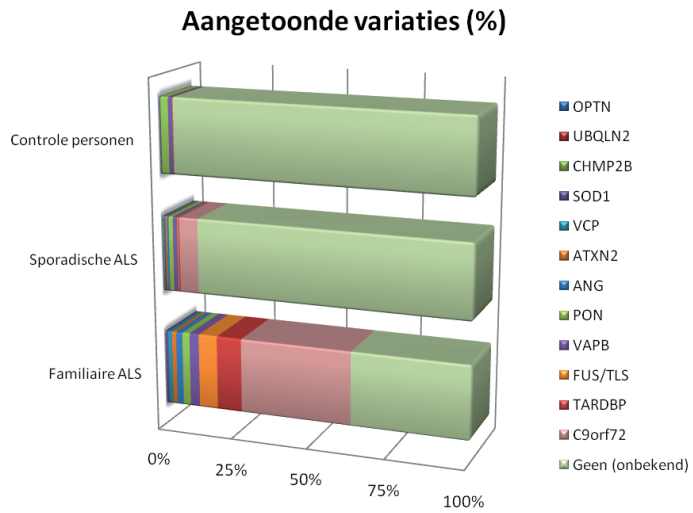


**Figure 20.3** Pie chart with frequencies of non-synonymous mutations (%). For FALS (A), SALS (B) and control subjects (C), the distribution of mutations in ALS-associated genes is shown. We refer to Table 20.1 and Supplementary Table 20.1 for more detailed information.



**Figure 20.4** Common pathways involved in the pathogenesis of ALS. The suggested effects of eleven ALS-associated genes are shown. Mutations in *OPTN*, *VCP*, *UBQLN2* and *VAPB* could impair protein degradation, which subsequently results in the accumulation of proteins (e.g. TDP-43) and aggregate formation. Repeat expansions in *ATXN2* and *C9orf72* probably lead to entrapment of flawed RNAs that attract many RNA-binding proteins (e.g. TDP-43), and thereby result in aggregate formation as well. *SOD1* and *PON* mutations appear to cause oxidative stress; mutant *SOD1* is also aggregation prone, and oxidation-induced misfolding most likely results in aggregate formation. Aggregation of mutant TDP-43 and *FUS/TLS* seems to disrupt the normal function of these proteins in RNA processing pathways, and additionally, could cause a toxic gain-of-function. *ANG* mutations probably raise ALS susceptibility, while they increase the vulnerability of neurons. To summarize, via diverse pathways these mutants lead to the formation of aggregates, which could be deleterious (neurotoxic) and/or impair cellular processes due to entrapment of proteins (loss-of-function). Eventually, this will result in degeneration of motor neurons, causing ALS.





**Figure S.1** Verdeling van de aangetoonde variaties in familiäre ALS-patiënten, sporadische ALS-patiënten en controle subjecten.